



# 2-WIRES DOOR ENTRY SYSTEM

DESIGN AND  
INSTALLATION  
TECHNICAL GUIDE



# 2 WIRES AUDIO & VIDEO DOOR ENTRY SYSTEM

TECHNICAL GUIDE	Section 1
GENERAL RULES FOR INSTALLATION	Section 2
WIRING DIAGRAMS / VARIANTS	Section 3
INSPECTION AND PUTTING INTO OPERATION	Section 4
CATALOGUE	Section 5

## GUIDE FOR DESIGN AND INSTALLATION



## CONTENTS

## 1. TECHNICAL GUIDE

2 WIRES system, the simplest solution for each installation . . . . .	1.1
Ideal for refurbishments and the renewal of the old door entry system.	1.2
The main devices . . . . .	1.3
The accessory devices . . . . .	1.4
The system functions . . . . .	1.5

## 2. GENERAL RULES FOR INSTALLATION

System layout. . . . .	2.1
SELV double insulation safety devices . . . . .	2.2
Installation of entrance panels . . . . .	2.3
Installation of internal units and DIN devices . . . . .	2.4
The cable . . . . .	2.5
Physical configuration - general information . . . . .	2.6
Configuration of entrance panels . . . . .	2.7
Audio systems . . . . .	2.8
System performance - audio systems . . . . .	2.9
Video systems . . . . .	2.10
Possible video systems . . . . .	2.11
System performance - single family video systems . . . . .	2.12
System performance - multi family video systems. . . . .	2.13
System expansion with interfaces. . . . .	2.14
Configuration of 346850 interface . . . . .	2.15
Configuration of 346851 interface . . . . .	2.16
Configuration of 346891 interface . . . . .	2.17
Classe 300EOS / Classe 100X connected video internal unit wiring rules . . . . .	2.18

### 3. WIRING DIAGRAMS

Example 1 - the villa . . . . .	3.1
Example 2 - the two-family villa . . . . .	3.2
Example 3 - The apartment building . . . . .	3.3
Example 4 - The apartment block . . . . .	3.4
Example 5 - The apartment . . . . .	3.5
Example 6 - The small house block . . . . .	3.6
1 or more main audio EP and secondary EP . . . . .	3.7
1 or more audio Entrance Panels . . . . .	3.8
One-family system with 1 or more audio Entrance Panels and 5 intercommunicating Internal Units. . . . .	3.9
Two-family system, 1 EP and 3 IU for each apartment with "Internal intercom and intercom among apartments" function. . . . .	3.10
1 or more main audio Entrance Panels with universal speaker unit . . . . .	3.11
Multifamily system with 1 or more main EP, 5 intercommunicating . . . . .	3.12
Multifamily system with several main audio EP and call to the guard station . . . . .	3.13
Video system with 1 EP and star-connected riser using non-twisted cables or pre-existing cables . . . . .	3.14
Multifamily video system with universal speaker module <a href="#">346991</a> and associated separate camera . . . . .	3.15
1 main video Entrance Panel and 1 riser with floor shunt wiring . . . . .	3.16
1 main video Entrance Panel and 2 risers with floor shunt wiring . . . . .	3.17
2 main video Entrance Panels and 1 riser with in-out wiring. . . . .	3.18
2 main video EP with additional power supply and star-connected riser . . . . .	3.19
One-family system with 1 video Entrance Panel and 5 Internal Units in parallel and intercommunicating . . . . .	3.20
Two-family system, 1 EP and 3 IU for each apartment with "Internal intercom and intercom among apartments" function. . . . .	3.21
Intercom in apartment without interface <a href="#">346850</a> . . . . .	3.22
Multifamily system with 1 main video EP, 2 risers and max. 5 intercom among apartments . . . . .	3.23
Multifamily system with 2 EP (1 with separate camera, 2 additional cameras and riser with apartment interface) . . . . .	3.24
System in apartment with 2 WIRES analog interface <a href="#">349410</a> . . . . .	3.25
System in apartment with apartment interface . . . . .	3.26
System line expansion with interface <a href="#">346851</a> . . . . .	3.27
Multifamily system with 39 risers with independent audio . . . . .	3.28
One-family system with max 16 cameras or Entrance Panels. . . . .	3.29

System with <a href="#">346851</a> module for Entrance Panel line doubling; max. 39 independent risers and apartment interfaces . . . . .	3.30
System with max 39 independent risers and riser extension (100 video IU) . . . . .	3.31
Internal Units expansion in apartment - (Example up to 10 IU). . . . .	3.32
System with 1 guard station and independent risers . . . . .	3.33
System with several guard stations and independent risers . . . .	3.34
Hierarchical system with 1 backbone GS and 1 GS for each independent riser . . . . .	3.35
Hierarchical system with backbone GS, riser GS and Slave GS on the backbone and on the riser . . . . .	3.36
2 wire/IP mixed system with guard station software . . . . .	3.37
Residential complex with 2 wire/IP mixed system . . . . .	3.38

### 3.1 WIRING DIAGRAMS VARIANTS

SFERA entrance panels . . . . .	3.1.1
Wiring diagrams variants of Entrance Panels/Cameras. . . . .	3.1.2
Internal Unit Variants - Single family or multifamily systems with apartment interface <a href="#">346850</a> . . . . .	3.1.3
Internal Units Variants - Multifamily systems without apartment interface <a href="#">346850</a> . . . . .	3.1.4
Internal Units Variants - Multifamily systems without apartment interface <a href="#">346850</a> . . . . .	3.1.5
Wiring diagrams variants for DIN rail devices . . . . .	3.1.6
Auxiliary services - Floor call . . . . .	3.1.7
Auxiliary services - Door lock control. . . . .	3.1.8
Auxiliary services - Staircase light control . . . . .	3.1.9

### 4. INSPECTION AND PUTTING INTO OPERATION

Inspection and putting into operation of a 2 WIRES system . . . . .	4.1
Diagnostic - Troubleshooting . . . . .	4.2

### 5. CATALOGUE

Pushbutton panels . . . . .	5.1
Internal units and Smart Security devices NETATMO . . . . .	5.2
Accessories . . . . .	5.3
Audio and video kits . . . . .	5.4
Glossary. . . . .	5.5
Technical sheets . . . . .	5.6





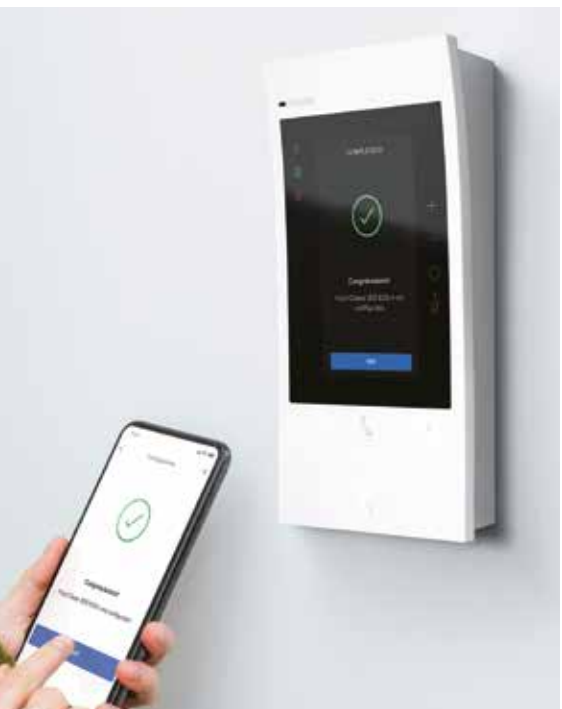

# 1 TECHNICAL GUIDE

# PRE-SALE SERVICE

**BTICINO** supports the creation of 2 WIRES audio & video door entry system with a dedicated estimate software.

**YouDiagram** is the BTicino software for the design of Door Entry Systems.

It allows to draw the single-line diagram of the system in PDF and DXF format, the configuration, choice and finishing of the devices, the verification of the absorptions and the installation rules on each system BUS.

Also provides the list items and the technical documentation of the devices in the project.

Free to download from [www.bticino.com](http://www.bticino.com) International website.

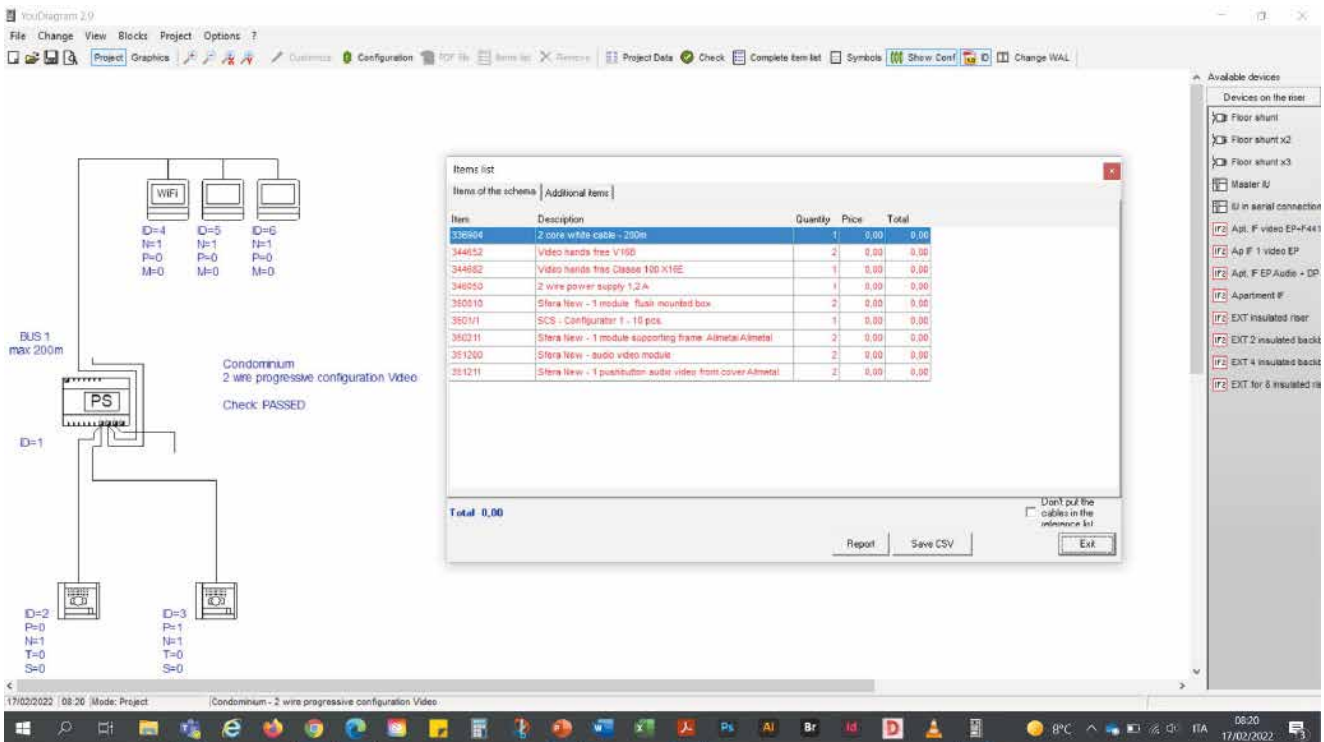

For further **TECHNICAL INFORMATION** see the 2-Wires Door Entry System technical guide



# AFTER SALE SERVICE

➤ For after sales TECHNICAL ASSISTANCE, please refer to the [www.bticino.com](http://www.bticino.com) and [www.legrand.com](http://www.legrand.com) - WORLD PRESENCE Web Sites in order to find your nearest subsidiaries :

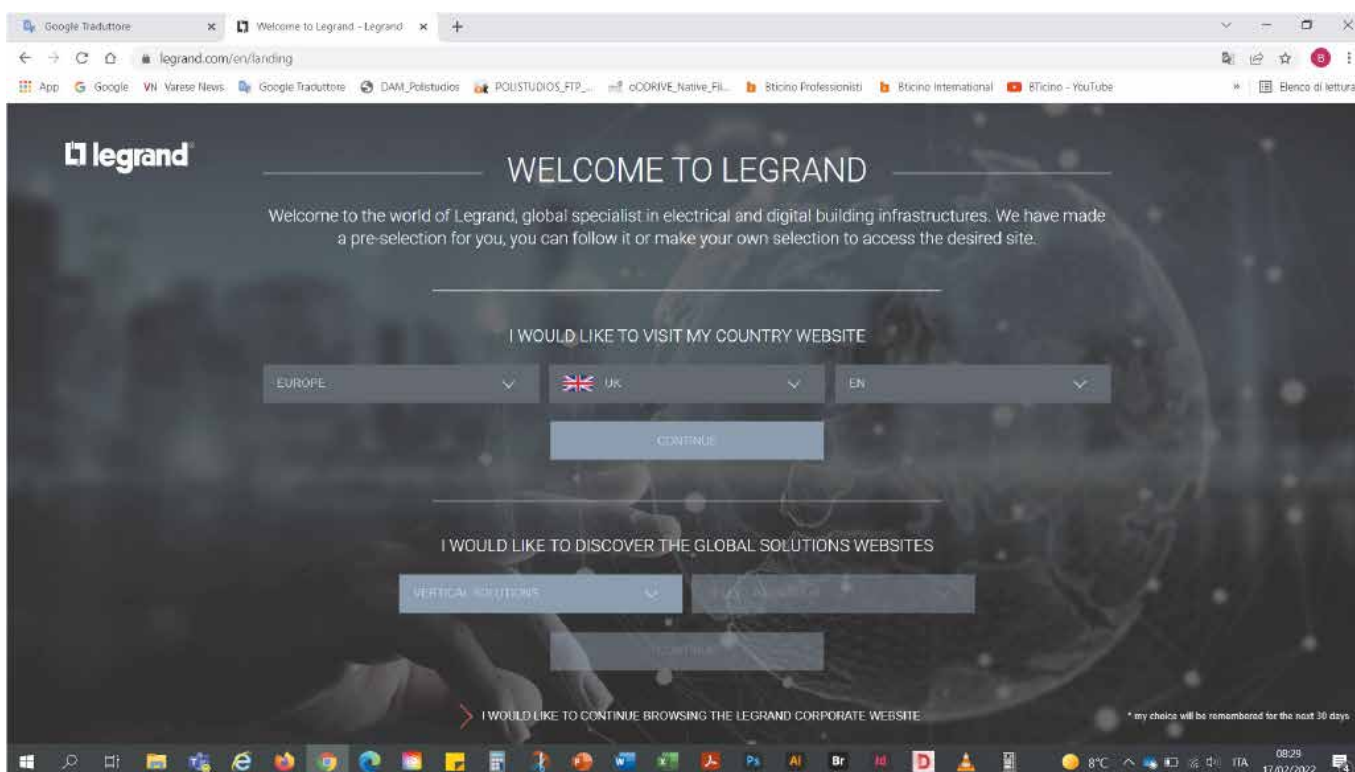
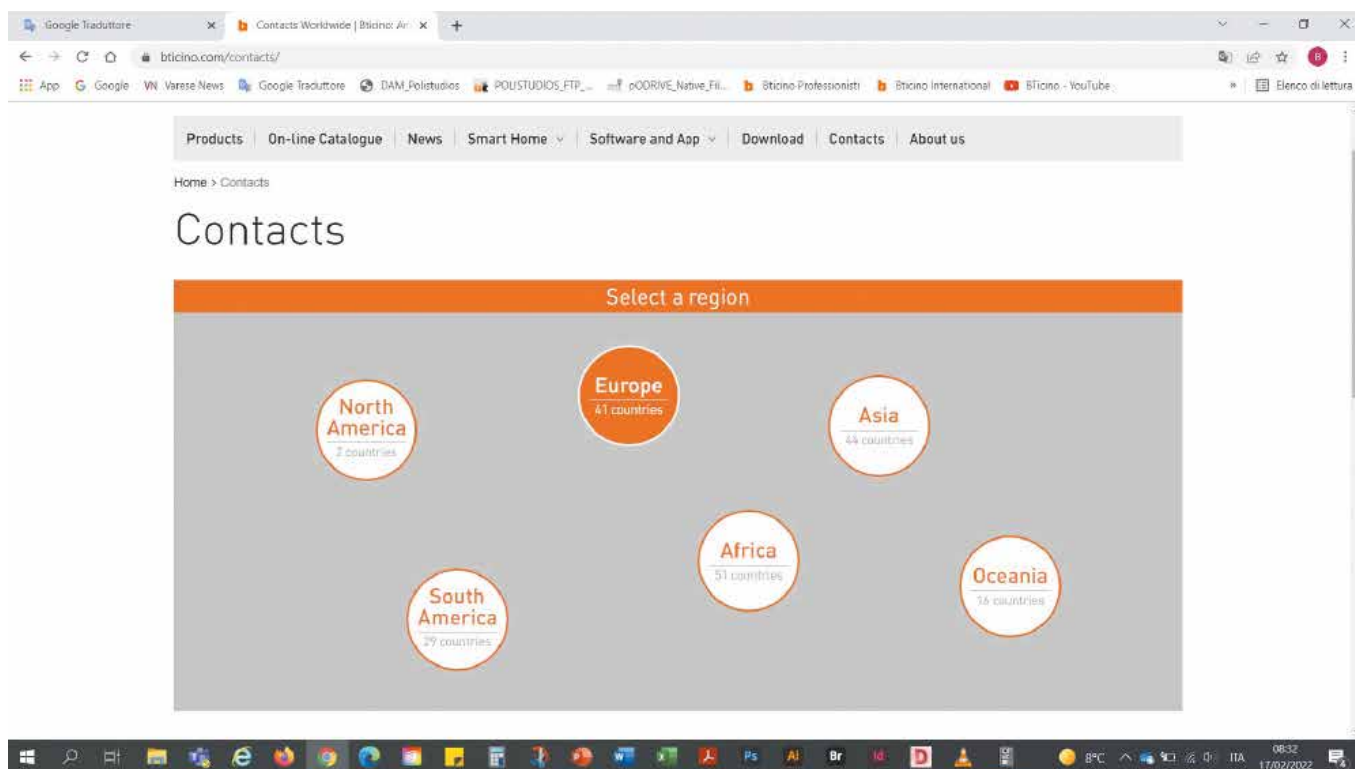

# 2 WIRES system, the simplest solution for each installation

## YOUR WORK IS EASIER

The 2 WIRES system is easy to use. Thanks to the NON-POLARISED 2 WIRES wiring of each part of the system, connection is simple,

easy and fault-proof. There will be no more mistakes and time lost due to subsequent interventions.



## HIGH PERFORMANCE

The 2 WIRES technology makes it possible to install all types of systems, from villa to the apartment complex systems, with the same ease. Moreover, the possibility of using the existing cables make it an ideal solution in refurbishments.

### THE APARTMENT BLOCK SYSTEM CAN HAVE:

<b>3900</b> Apartments	<b>3900</b> Apartment video entrance panels
<b>3</b> Internal Units for apartment	<b>39</b> Risers with independent audio
<b>96</b> Common video Entrance Panels	<b>16</b> Guard stations

Entrance Panel



The furthest internal unit



600 metres

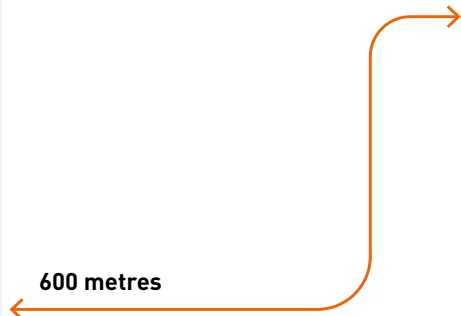

The villa



The apartment



The apartment block



The small house block

## MAXIMUM VERSATILITY

The 2 WIRES system is designed to guarantee high versatility and adaptation to the needs of every customer.

The 2 WIRES technology allows you to have a door entry system ready for the subsequent addition

of the video function, and is ideal in mixed audio/video systems, to meet the needs of the individual residents. It also offers a wide range of entrance panels and internal units to fit the individual users: from basic door entry

functions to the forwarding of calls to a smartphone.



## INTEGRATION WITH IP TECHNOLOGY

The 2 WIRES and IP technologies may be integrated for the installation of large systems. Thanks to the dedicated LAN

network, with the IP technology it is possible to obtain high system performance levels: long distances, multichannel functions, software guard station, reception and central management of alarms.

Software IP guard station

### THE SYSTEM CAN HAVE:

**1000** Video Entrance Panels      **10000** Video Internal Units

**100** IP devices      **10 Km** Distance from the Entrance Panel to the last Internal Unit

**5** Simultaneous calls on the IP backbone

IP/2 WIRES interface



**CAUTION: Classe 300E0S and HOMETOUCH, CANNOT be used in systems with IP/2 Wires interface.**

## GENERAL FEATURES

# Ideal for refurbishments and the renewal of the old door entry system.

The 2 WIRES system offers many advantages for the refurbishment of existing systems: reduced intervention times, ease of execution and consequential cost reduction.

The customer will be able to enjoy aesthetically advanced devices and a wide range of new functions.

## REUSE OF EXISTING CABLES



Removal of the existing entrance panel



Use of an existing pair of wires to connect the new entrance panel

**No need to remove the existing cables and lay the new ones**

## REUSE OF FLUSH-MOUNTED BOXES



Example: Tersystem or SFERA Classic  
2-module flush mounted box



SFERA NEW



SFERA Robur

Or



Linea 3000

**No masonry works required to replace the existing flush mounted box**

## SWITCHING TO VIDEO IS EASY AND IMMEDIATE



Easy shift from the old analogue audio system to the new 2 WIRES colour video system

## BETTER APPEARANCE AND FUNCTIONS



In addition to the modern look of the device, the system also offers some additional functions:

- Intercom
- staircase light control
- release of the additional door lock
- call repetition on smartphone
- additional activations
- Alexa voice control
- Netatmo safety devices management

# The main devices

## ENTRANCE PANEL

Audio or video outdoor pushbutton panel with colour camera. Possibility of calling audio/video internal units and activate an associated lock. The call can be sent using the keys, by selecting the name on the display, or by entering a code on the keypad. The lock can also be operated using a proximity reader (RFID) or by entering a numerical code on the keypad (only available with preset pushbutton panels).

Available in different styles, finishes, and installation types (wall mounted, flush mounted, with anti-tampering protection and with rainshield).

### SFERA NEW



Video with 1 module



Video with 2 pushbutton call modules



Video with 3 digital call modules and door lock release reader

### SFERA ROBUR



Video with 2 pushbutton call modules



Video with 3 digital call modules, numerical keypad and nameplate modules

### LINEA 3000



Audio



Video



### LINEA 2000



Audio



Video

### LINEA 300



Anti-tamper video





## INTERNAL UNIT (AUDIO AND VIDEO INTERNAL UNITS)

Colour video and audio internal units for the reception of calls from the external pushbutton panel and activation of the corresponding lock. Available in different styles and installation types (wall mounted, table top).

Using specific keys or the menu (preset video internal units only), they give the possibility of managing the video door entry functions (e.g. activation of any cameras, locks, intercom calls, etc.).

Handsfree communication or with handset.

### CLASSE 300EOS AND CLASSE 100X CONNECTED VIDEO INTERNAL UNITS



Handsfree video internal units with integrated Wi-Fi connectivity

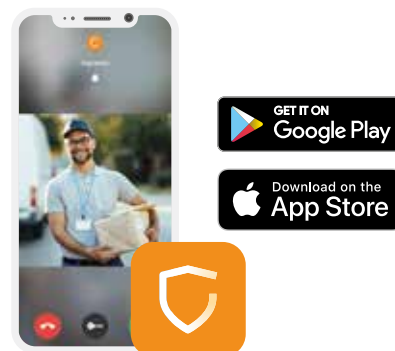

Classe 300EOS with Netatmo and Classe 100X are video internal units that give the possibility of forwarding the video door entry call to a mobile device. The integrated Wi-Fi connectivity allows connection with your smartphone. Thanks to the dedicated App, both while in your home and when away you will be able to manage video door entry calls, video door entry answering machine functions (Classe 300EOS), the activation of door locks and cameras, the timed activation of lights / garden watering systems and the Netatmo safety devices management (Classe 300EOS) using the smartphone.

Home + Security is the free APP for Android and iOS smartphones which can be downloaded from the respective digital stores. Configuring the App needs just a few steps and, thanks to the BTicino Cloud, the connection is totally automated and managed with the maximum level of security.

### CLASSE 100



Video internal units

### CLASSE 100



Handsfree audio internal unit

Internal unit with handset

### SPRINT L2



Internal unit with handset

## The main devices

### POWER SUPPLIES

They generate the system 2 WIRES BUS and power the devices of the system. The power supplies are SELV double insulation safety devices. Three types of power supplies are available:

- ▶ **346040** Power supply for 2 wires audio systems in 6 DIN modular enclosure. Power supply PRI 110 – 240 Va.c.@50 – 60 Hz. It supplies a maximum output current of 600 mA.
- ▶ **346050** Power supply for 2 wires audio and video systems (with integrated video adapter) in 6 DIN modular enclosure. Power supply PRI 110 – 240 Va.c.@50 – 60 Hz. It supplies a maximum output current of 1.2 A distributed on the three outputs (IU BUS), (TK BUS) and (SCS).
- ▶ **346030** Compact power supply for 2 wires audio and video systems (with integrated video adapter) in 2 DIN modular enclosure. Suitable for small audio or video one-family systems. Power supply PRI 230 Va.c.@50 – 60 Hz. It supplies a maximum output current of 600 mA.
- ▶ **346020** Additional power supply in 2 DIN modular enclosure. It gives the possibility of locally powering entrance panels and internal units fitted with connection clamps (1 - 2). Power supply PRI 220 – 240 Va.c. It supplies a maximum output current of 600 mA.



Audio power supply  
**346040**



Audio and video power supply  
**346050**



Audio and video compact power supply  
**346030**



Additional power supply **346020**

### AUDIO VIDEO NODE

It gives the possibility of mixing audio / video signals for the connection to the system of external pushbutton panels and/ or 2 WIRES cameras. It gives the possibility of connecting up to four 2 WIRES external pushbutton panels / cameras and the generation of four 2 WIRES risers.

It must be used in conjunction with the system power supply, item **346050**. Device in 6 DIN modular enclosure.

**In order to avoid jeopardising the possibility of future system expansions, the use of the audio video node is recommended with this system setup.**

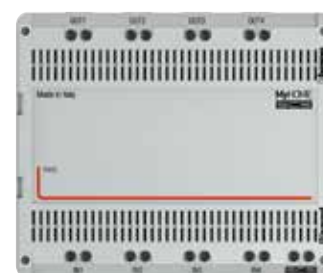

Audio video node  
**F441**

### FLOOR SHUNT

Can make 2 WIRES video door entry systems with star wiring distribution. It automatically adapts the video signal. Its small size means it can also be placed inside the flush-mounted box. Device in Basic enclosure with 4 outputs.



Floor shunt  
**346841**

## ACTUATORS

They give the possibility of controlling / activating additional electric locks, or activating generic loads (e.g. staircase lights, lamp for the illumination of the field of vision of the camera, call forwarding to external devices, etc.) directly from preset video internal units.

Three types of actuators are available:

- > [346210](#) Relay actuator for generic loads in 2 DIN modular enclosure.
- > [346230](#) Relay actuator for door lock in 2 DIN modular enclosure.
- > [346260](#) Timed relay actuator for door lock in 4 DIN modular enclosure.



Generic actuator  
[346210](#)



Door lock actuator  
[346230](#)



Timed actuator  
[346260](#)

## APARTMENT INTERFACE

It gives the possibility of installing a dedicated apartment system, independent from the apartment block riser. In the apartment, it will therefore be possible to install a video door entry system with dedicated private external pushbutton panels / cameras, possibly also integrated with the home automation system. Device in 4 DIN modular enclosure.



Apartment interface  
[346850](#)

## SYSTEM EXPANSION INTERFACE

It gives the possibility of increasing the number of devices connected to the 2 WIRES system, of reaching the maximum installation distances, of generating risers with independent audio, and expanding the apartment system performance.



System expansion interface  
[346851](#)

# The accessory devices

## RELAY MODULE

It gives the possibility of operating "non-standard" door locks. The device must be connected to the (S+/S-) clamp of the speaker module of the entrance panel.



Relay module  
**346250**

## COAX / 2 WIRES INTERFACE

Can connect the cameras with 12 Vd.c. power supply (consumption 150 mA max) and coaxial video output (1 Vpp @ 75ohm) to the video 2 WIRES BUS. The interface directly powers the camera. The device may be used as separate camera interface. In order to associate a camera to an audio entrance panel, it will be enough to configure the interface and the entrance panel with the same configurator in the P position.



Coax / 2 wires interface  
**347400**

Video internal unit

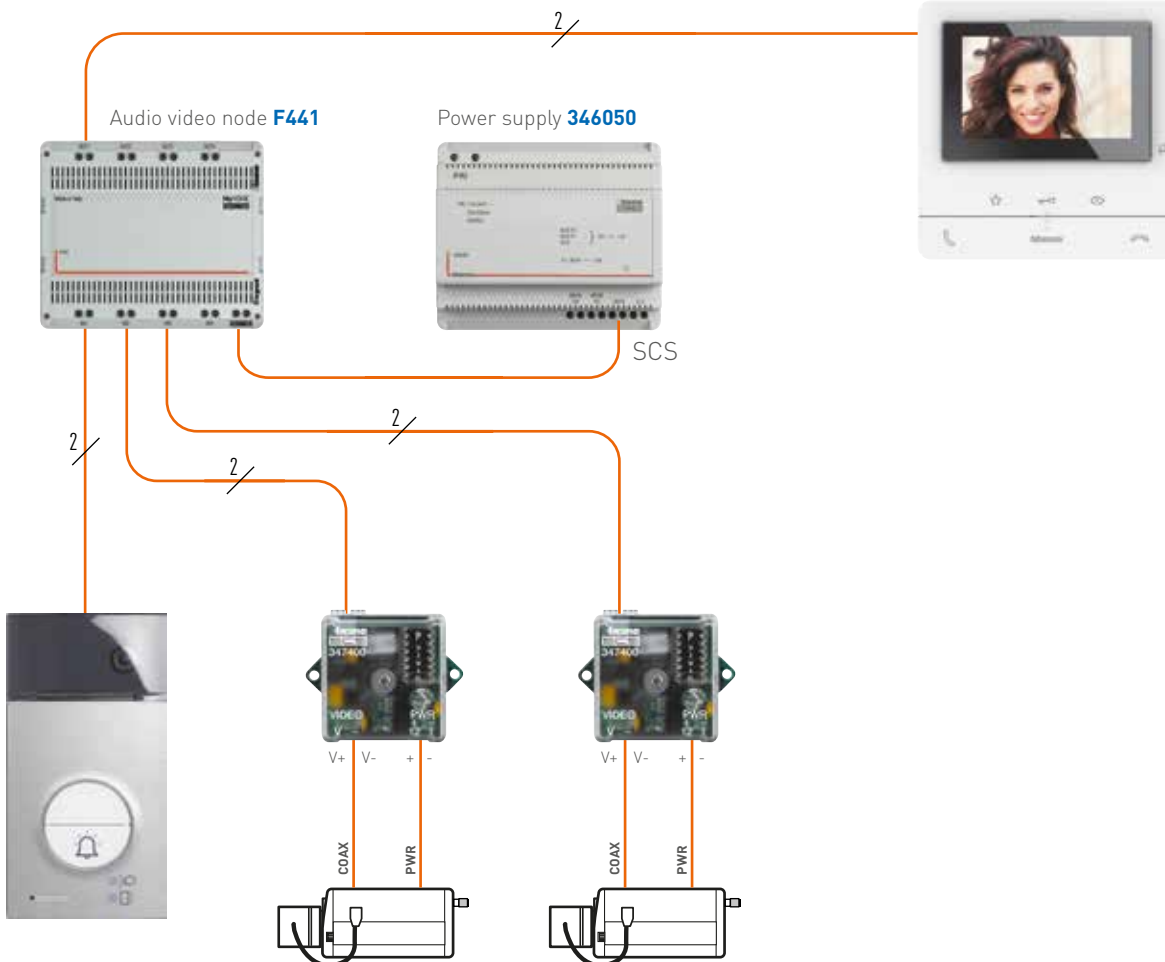

## ADDITIONAL RINGTONE

Can repeat the audio/video door entry call in several rooms.

The connection is completed with 2 wires directly connected to the clamps.

Available in "neutral" finish, wall mounted installation without the need of additional accessories.



Neutral additional ringtone  
**336910**

## GUARD STATION

It's a tabletop device suitable for 2 wires multi-family systems that provides access to the various apartment block video door entry system services: intercommunication among apartments, management of door locks and staircase lights, monitoring of cameras installed in common areas. It has a large 7" LCD colour display with icon menu, handset and handsfree.

It gives the possibility of creating an internal unit, external pushbutton panel and guard station address book.

It is possible to connect to the system up to 16 guard stations.



Guard station  
**346310**

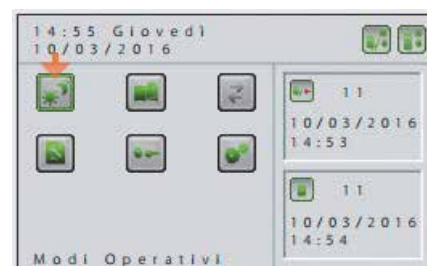
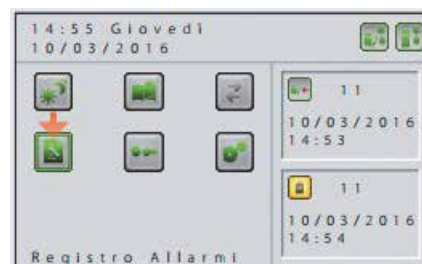
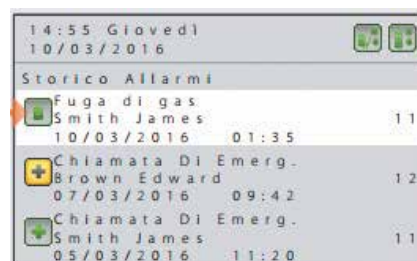

# The system functions

## THE CALL

When the call key of the entrance panel is pressed, the system generates a signal that is only recognised by the intended recipient's internal unit/s (a period of 30 seconds is allowed to answer the call after the pressure of the key). The internal units are uniquely configured. When the call is received, the internal unit rings and the monitor (if present) turns on. When the connection key is pressed, or the handset is lifted, the communication with the entrance panel is established (maximum conversation time 1 minute). When the communication key is pressed again, or the handset is replaced, communication is interrupted and the monitor turns off.

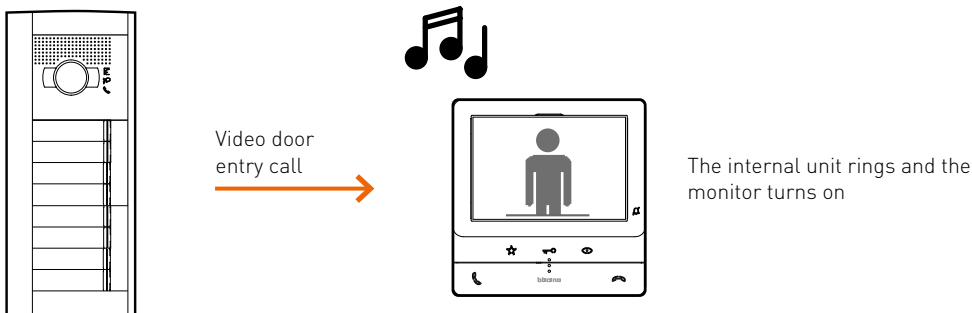

## CONVERSATION SECRECY

During the conversation between the entrance panel and the internal unit, any other entrance panels and internal units not involved in the communication are temporarily excluded, therefore ensuring the privacy of the conversation. When a call is made from a temporarily excluded entrance panel an engaged sound will indicated to the user that the internal line is momentarily busy.

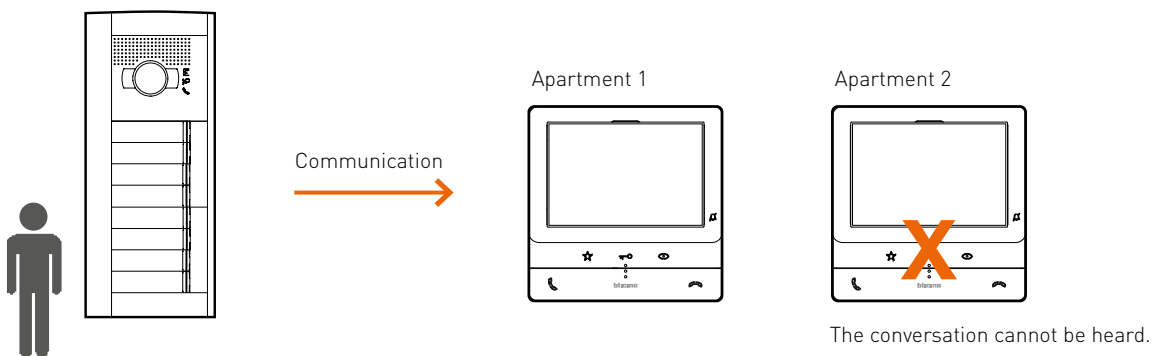

## SIMULTANEOUS SWITCHING ON

With preset video internal units, simultaneous switching on of the monitors is also possible: when the call is received, all the internal units ring and the monitors of all video internal units turn on. When the call is answered, only the monitor of the video internal unit that has established communication with the entrance panel will stay on. For this function to be possible, all the video internal units with the exception of one must be powered locally through the additional power supply unit, item [346020](#).

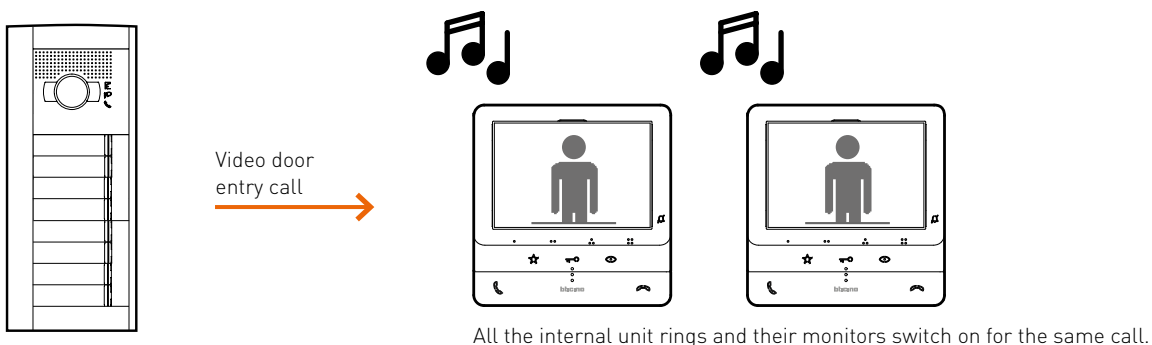

## MASTER-SLAVE FUNCTION

All video internal units have a MASTER-SLAVE function: when the call is received, all the internal units ring but only the monitor of the video internal unit set as MASTER switches on. When the auto-switching on key is pressed on a SLAVE, the monitor of the MASTER internal unit switches off and the monitor of the SLAVE switches on (without necessarily establishing communication with the entrance panel). When the connection key is pressed, or the handset is lifted, the communication with the entrance panel is established (maximum conversation time 1 minute).

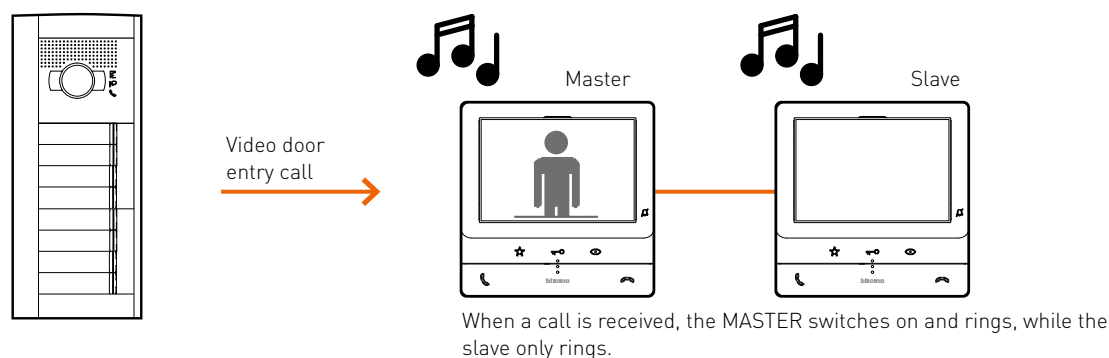

## DOOR LOCK RELEASE

All internal units have a door lock key, which can be pressed to order the opening of one of the system locks. With the system idle, pressing the key opens the door lock of the associated entrance panel (the association is completed using the P configurator of the internal unit). In case of active call, it opens the door lock/actuator associated to the entrance panel that has made the call.



## RELEASE OF THE ADDITIONAL DOOR LOCK

In case of request of opening of one or more door locks in addition to the main one (directly connected to the speaker module of the entrance panel), it will be necessary to use a specific actuator: generic actuator item [346210](#) or door lock actuator item [346230](#) or [346260](#) (the latter offers better door lock timing flexibility when compared with item [346230](#)). The correctly configured actuator is controlled by the dedicated internal unit pushbutton. Critical electric locks may be powered using an auxiliary transformer.

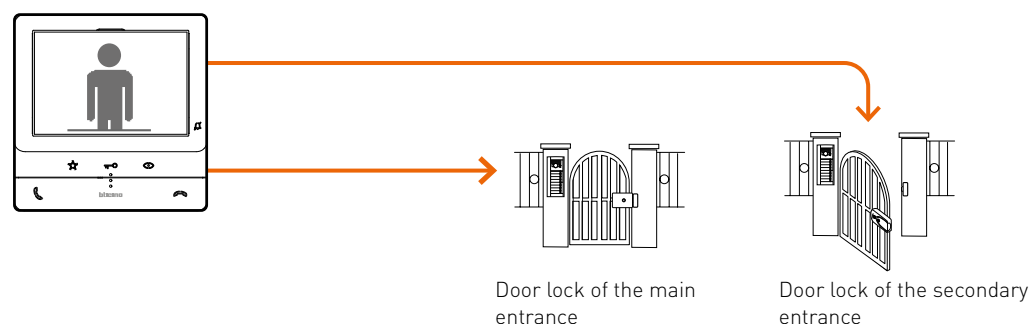

In order to use this function, a generic actuator, item [346210](#) (2 DIN) or a door lock actuator [346230](#) (2 DIN) / [346260](#) (4 DIN), are required.

# The system functions

## RELEASE OF 2 DOOR LOCKS WITH CODE-LOCK

By using the Sfera [353000](#) keypad module configured with M=3 - (and integrated in the external pushbutton panel with the speaker module), it is possible to control the activation of 2 separate door locks with a numerical code. The device manages both the door lock connected to the speaker module / AV module of the entrance panel, and any door locks directly connected to the clamps of the local relay, item [353000](#) (the latter requires dedicated power supply).

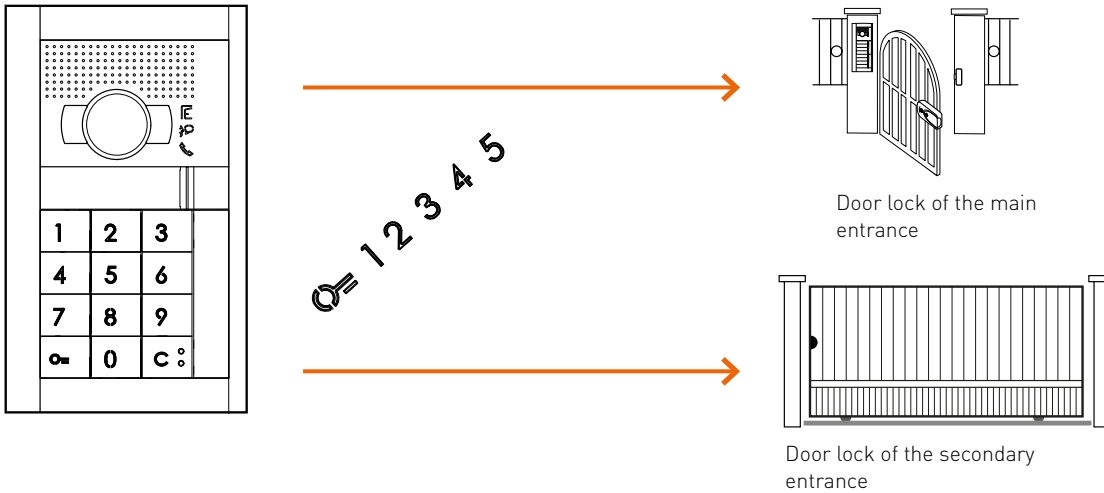

## ACTIVATION

Audio and video internal units have a dedicated key that controls (by default) an actuator item [346210](#) configured in staircase light mode. The key may also be configured for other functions.

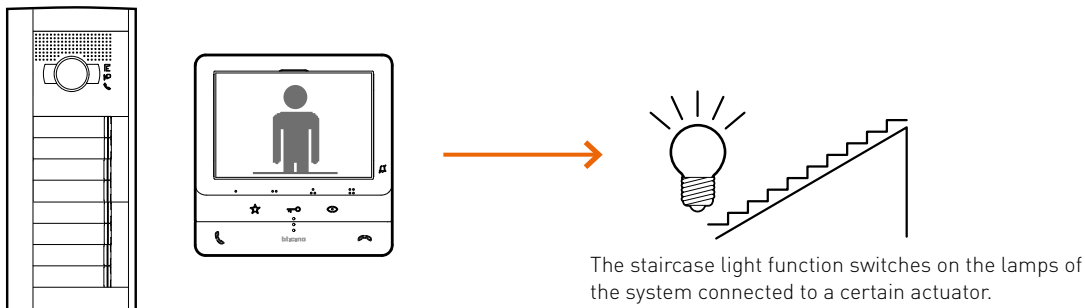

In order to use this function, a generic actuator, item [346210](#) (2 DIN) is required.

## AUTO-SWITCHING ON

Pressing the auto-switching on key with the video internal unit idle will establish communication with the entrance panel associated through the P configuration of the internal unit. Continue pressing the auto-switching on key to cycle through the various entrance panels/cameras connected to the system.

The auto-switching on function is not available when the system is already "engaged" in a conversation between entrance panel and internal unit.

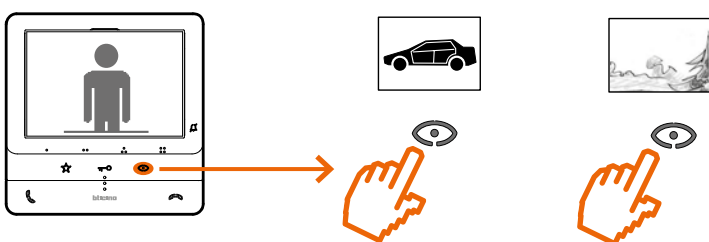

Every time that the auto-switching on key is pressed, the images displayed change.



## INTERCOM CALL

The system offers an INTERCOM function, for communications of 3 min. maximum between video internal units:

- › of different apartments
- › of the same apartment.

If the apartment has an apartment interface [346850](#) or is a single-family unit, it is possible to separately call the individual apartment video internal units. In this case, the INTERCOM connection can take place while other connections to the outside of the apartment are also active. However, if the apartment has no apartment interface [346850](#), an apartment internal unit can call all the internal units of the apartment itself, but the INTERCOM connection cannot take place while other connections to the outside of the apartment are active. Any calls from the entrance panel or other apartments will take priority, therefore stopping the INTERCOM communication.

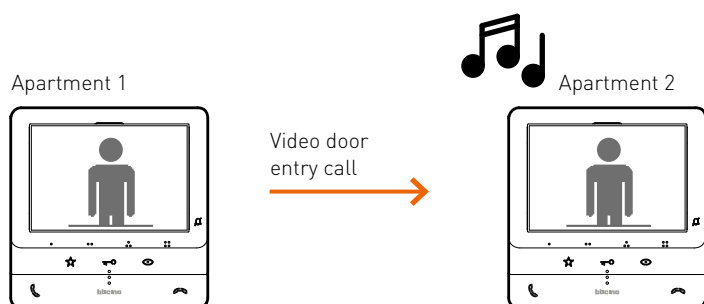

## GENERAL INTERCOM CALL

The general intercom call is only possible inside the apartment (therefore with interface [346850](#)) or in a single-family context. By appropriately configuring the video internal unit, with a specific device it will be possible to make an intercom call to the other internal units of the apartment itself. The general intercom connection cannot be active at the same time as other connections. Calls from the entrance panel will take priority, therefore stopping the INTERCOM connection.

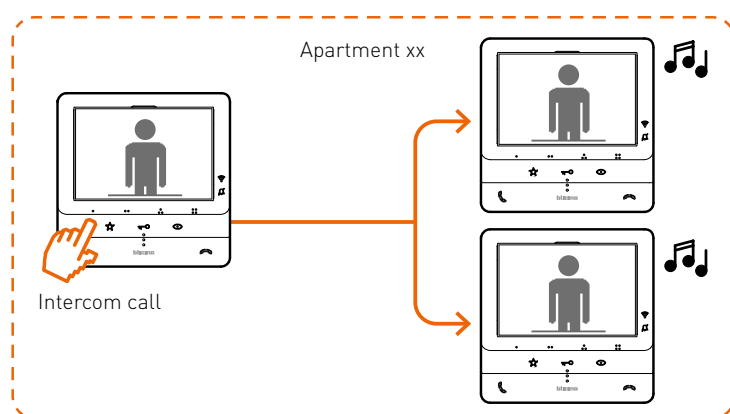

## PRESET INTERCOM CALL

From the preset internal units of the apartment block system it is possible to send an INTERCOM call to one single internal unit (for example the caretaker's internal unit). This internal unit receives intercom calls but CAN NOT send them. Calls from the entrance panel will take priority, therefore stopping the intercom connection.

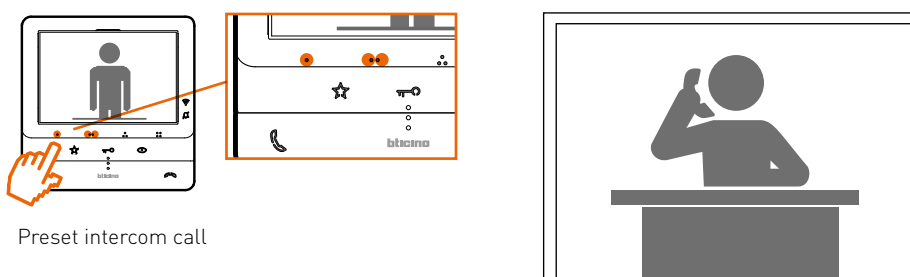

# The system functions

## PAGER FUNCTION (NOTIFICATION)

The function can be activated only inside the apartment (therefore with interface [346850](#)) or in a single-family context. This function (only available with handsfree devices) gives the possibility of broadcasting a voice message from the microphone of the audio/video internal unit (preset internal units only) to the speakers of the sound system. To activate briefly press the "Connection" key while the device is in the idle condition. The activation of the function is confirmed by the green LED coming on. Audio activates automatically.

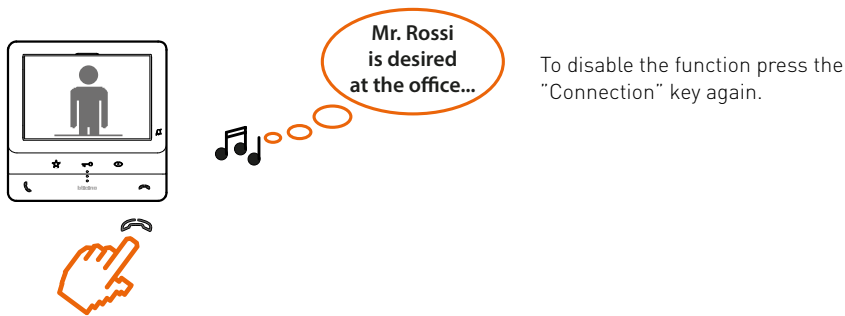

## CALL REPETITION ON SMARTPHONE

In single and multi family systems with Classe 300EOS and Classe 100X video internal units it is possible to set the forwarding of the video call to a smartphone (android and ios). The video internal unit integrated Wi-Fi connectivity allows connection with a mobile device. The dedicated Home + Security App can be downloaded free from the digital stores (Google Play & Apple Store). Classe 300EOS / Classe 100X internal units give the possibility of managing the system both while at home and when out: taking video/audio entrance panel calls, electric door lock control and activation of any cameras connected to the video/audio door entry system using a smartphone.

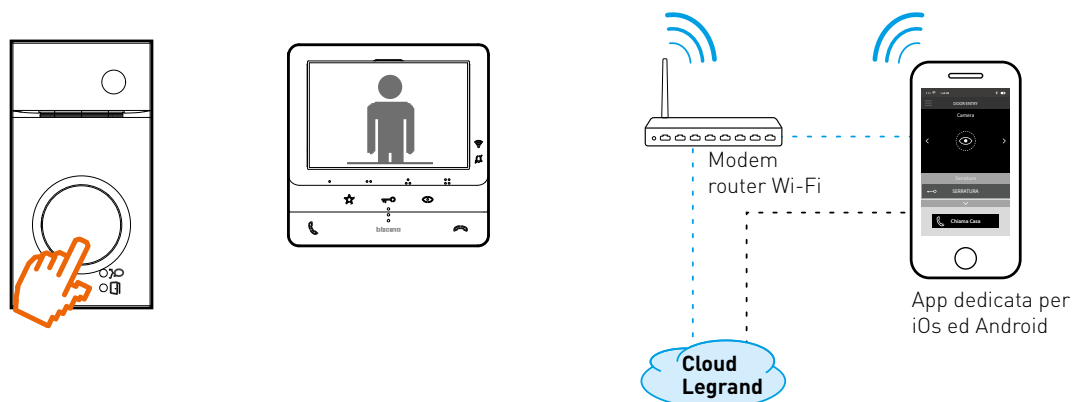

## PROFESSIONAL STUDIO (OFFICE) FUNCTION

This function is used mainly in the service sector (offices, GP Doctors surgeries, professionals), and in all those situations when the opening of the gate or the entrance door is required without physical interaction with the internal unit. When a person rings from the entrance panel, the internal unit rings, the video if present switches on and the associated door lock is activated without the need for anyone to press the internal unit door lock key.

- In order to use this function, the internal unit must be configured appropriately, after which it can be enabled/disabled as needed.
- It cannot be activated together with the DOOR STATUS function.

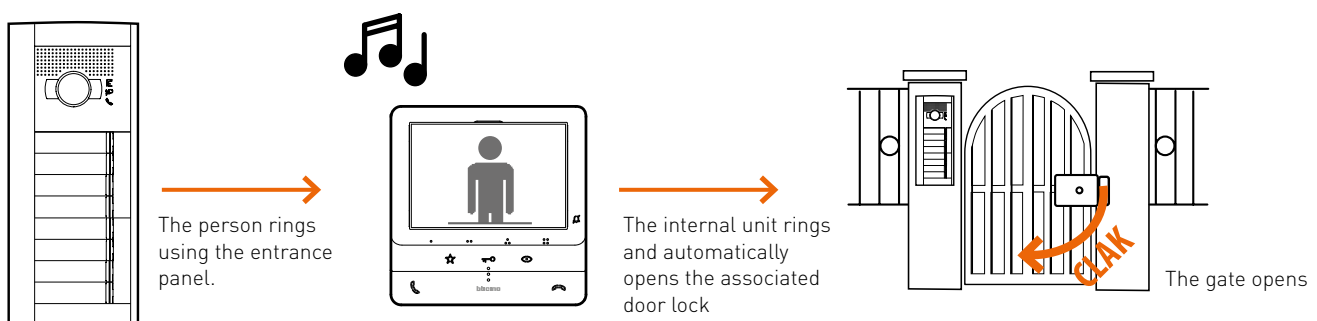

## DOOR STATUS FUNCTION

Using internal units equipped with a specific notification LED and the door lock actuator item [346260](#) installed in the system, it is possible to control the status of doors and gates. When the gate is open, the notification red LED flashes; when the gate is closed the LED is off. In case of control of 2 or more entrances, the LED is off when all of them are closed, and is on when at least one of them is open.

It cannot be activated together with the PROFESSIONAL STUDIO (OFFICE) function.

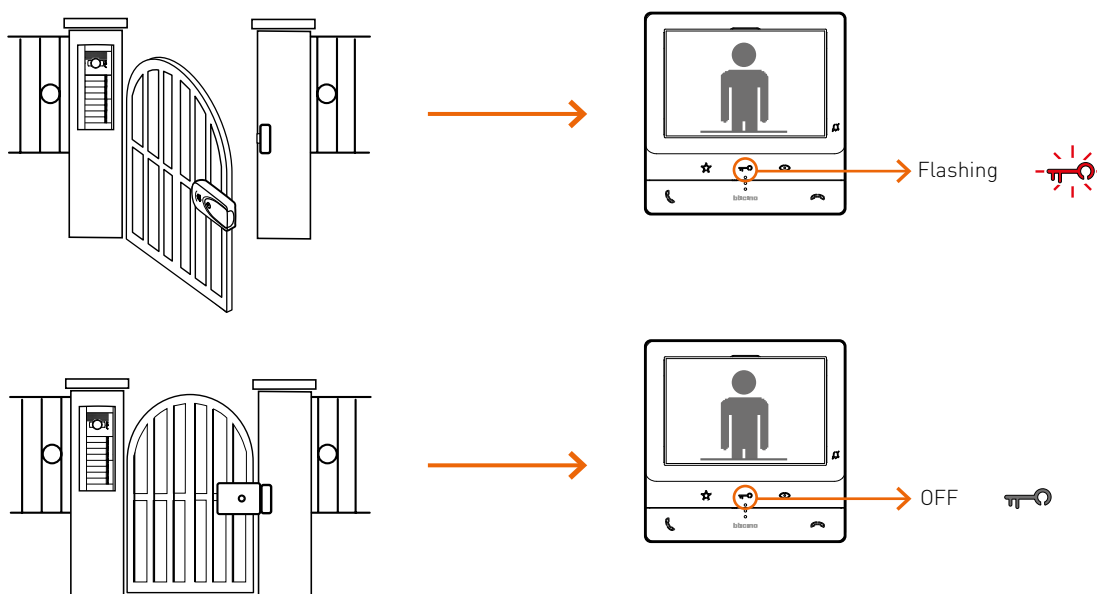

## FLOOR CALL FUNCTION

The internal units (audio and video) of the 2 WIRES system make it possible to take advantage of the CALL TO THE FLOOR function; by connecting a pushbutton to the clamps (ET / ) , it is possible to use the ringtone of the devices to make calls from the apartment entrance door. In installations with internal units connected in parallel, only the internal unit to which the call pushbutton is connected will ring.

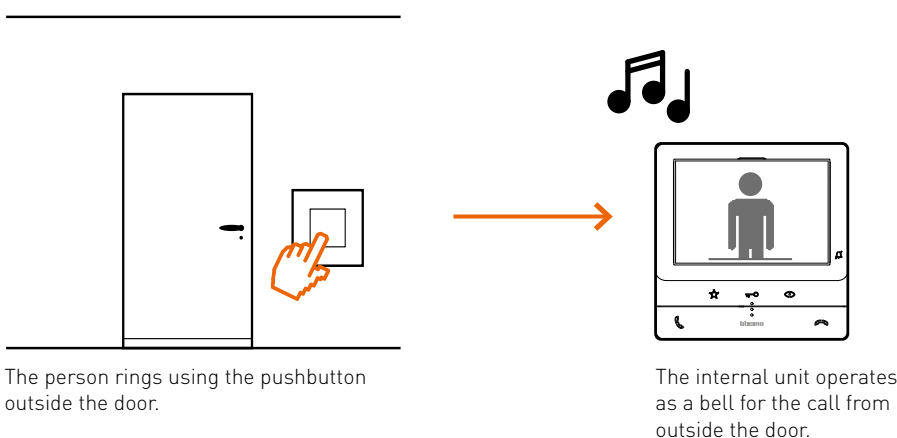

# The system functions

## INTEGRATION WITH NETATMO CAMERAS

Function available with **CLASSE 300E0S (344842)** and **CLASSE 100X (344682)** **connected** video internal units.

Thanks to the Wi-Fi connectivity and device interoperability, it is possible to integrate the connected video internal units with Netatmo indoor and outdoor smart cameras. The association with NETATMO cameras allows to use the face recognition function, when a call is received from the entrance panel and it can show if someone is in your home. The integration allows to display the BTicino and Netatmo camera video in an integrated way from a single App: **Home + Security**. Through the same App, it is also possible to manage the products of the Netatmo security range (outdoor and indoor cameras, door and window sensors, indoor siren and smoke detector). This allows you to quickly and easily create a Smart security system.

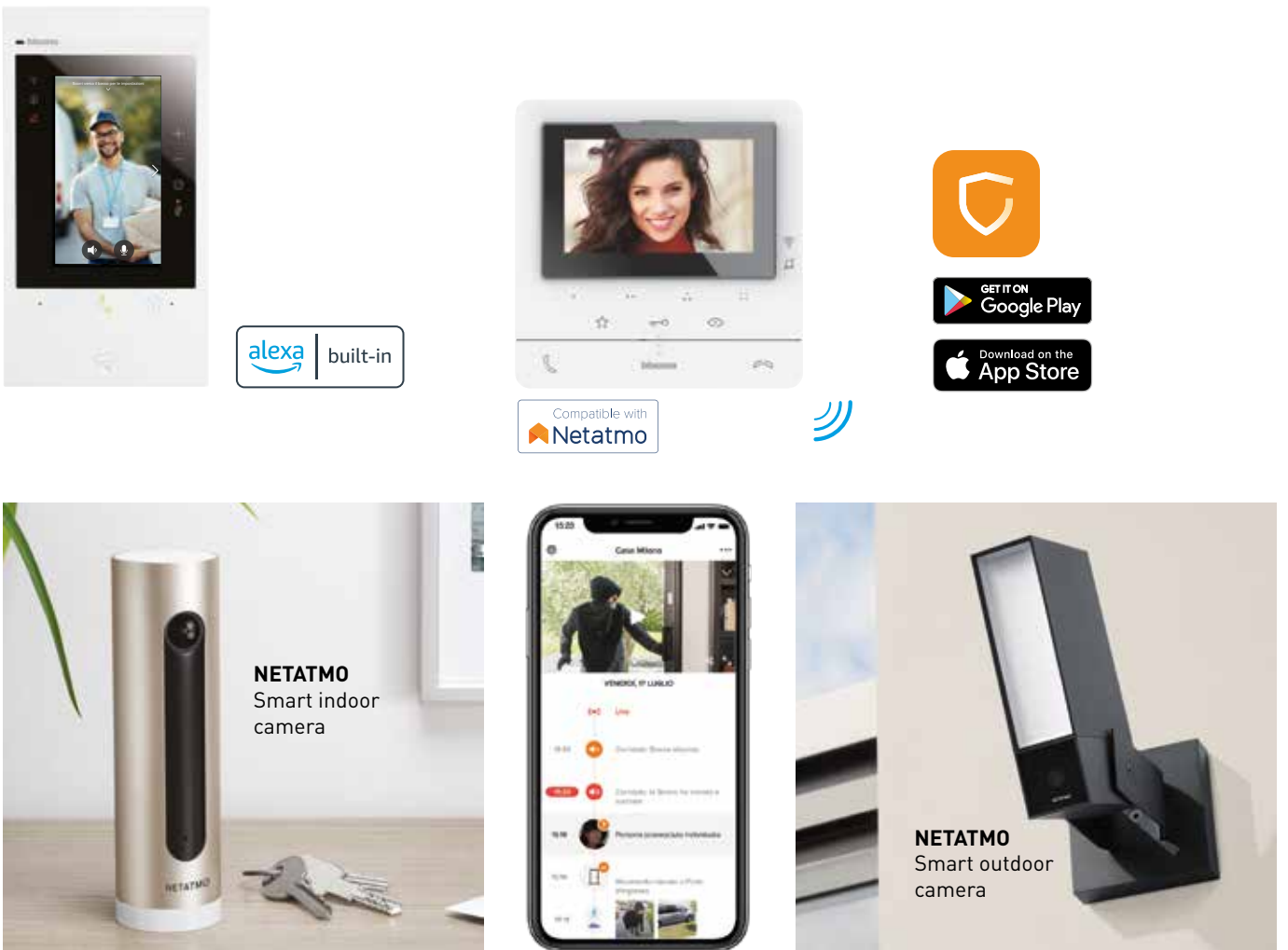

The configuration to associate the devices is very simple and no extra wiring/accessory is required. For both video internal units, it is necessary to have the credentials (Username & Password) of the Netatmo account previously created.

## VIDEO DOOR ENTRY ANSWERING MACHINE FUNCTION

Function only available when using the Classe 300EOS (344842) video internal unit. Activate the answering system to record a film clip of the visitor who was looking for you. The recorded videos are available and visible by the user on the video internal unit screen or on the Home + Security App together with the date and time.

It is also possible to record an audio message to play back on the entrance panel in case of unanswered call.

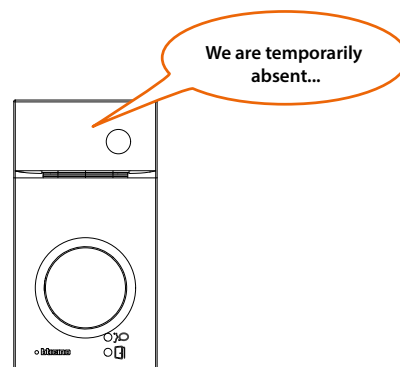
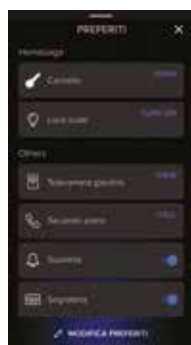

## PUSH TO TALK FUNCTION

If the entrance panel is in a particularly noisy zone/position, during the communication it will be possible to enable the PUSH TO TALK function (it can be activated only from the preset handsfree internal units), which will provide a better quality of communication. The function can be enabled / disabled directly from the internal units (enabling / disabling procedure available on the individual technical specifications).



## SAFE DOOR LOCK FUNCTION

This function is available with Classe 100 audio and video internal units and with Classe 300EOS video internal unit.

When it is active, **it prevents the opening of the electric door lock connected to the entrance panel, when the internal unit is in stand-by. The electric door lock opens only when the entrance panel and the internal unit are in audio communication.**

To activate the function, it is necessary to move the appropriate microswitch (located on the back of the internal unit) to the position

**NOTE:** the "Safe Door Lock" function CANNOT be activated together with the "Professional Studio (Office)" function.

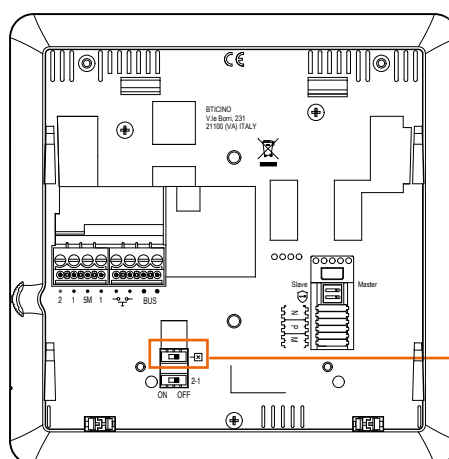

**NOTE:** when the function is active, all the keys (in all the configurations requiring the activation of a door lock) are disabled, and when they are pressed the white LED flashes.



# The system functions

## GUARD STATION

Available for multi-family installation, the 2 WIRES guard station offers central management and supervision of the various apartment block video door entry system services. Using this device, it is possible to communicate with the apartments, manage the door lock control, switch on the staircase lights, monitor the cameras connected to the common sections of the system, and any alarms from apartments or common areas. It is possible to connect to the guard station an additional bell type ringtone for call forwarding purposes. The device has a customisable address book for internal units, entrance panels and any other connected guard stations.

The internal unit calls the guard station using the AUTO-SWITCHING ON key. In case of handsfree internal units, when the guard station operator lifts the handset the internal unit rings, and when the CONNECTION key is pressed it is possible to speak with the guard station operator.

With internal units with handset, 2 different situations can occur:

- Call with the handset down (same behaviour as handsfree internal units)
- Call with the handset lifted: when the guard station operator lifts the handset, on the internal unit it will be necessary to put down and then lift the handset again to communicate.

If the guard station is engaged, the call is placed into a queue and will be managed by the guard station operator, who will select it from the call list.

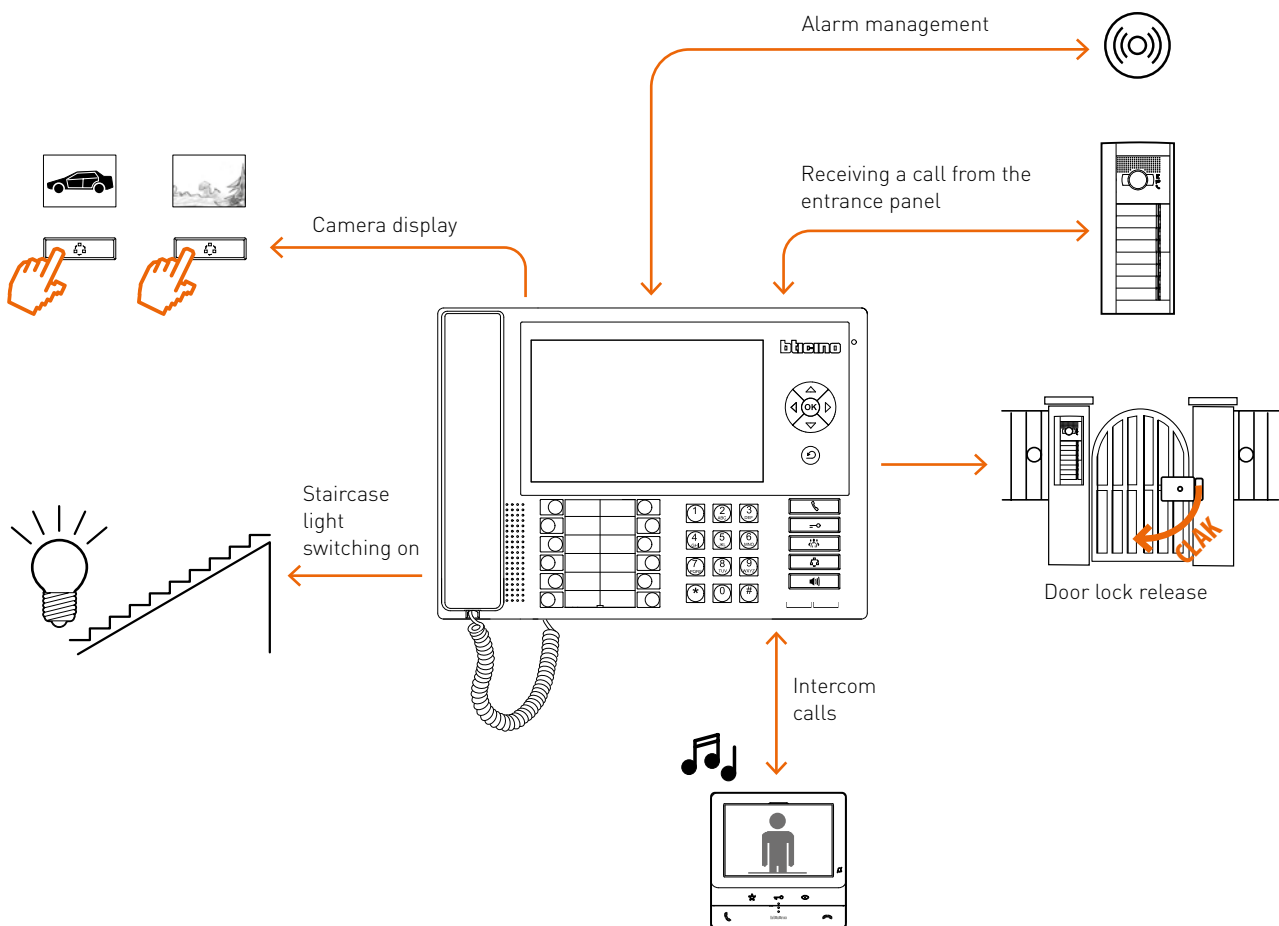

## SERVICE INTERNAL UNIT (Only systems with Guard station)

The service internal unit is an internal unit associated to the guard station that allows the operator, for example caretaker or receptionist, to also answer entrance panel calls. This could be the internal unit of their own apartment or office.



## 2 GENERAL RULES FOR INSTALLATION

# System layout

## GENERAL INFORMATION

The first step for the installation of an electric/audio or video door entry system is to design and complete a good basic setup. Appropriate arrangement of cables, conduits, boxes, technical rooms and control points, all make the installation and the future addition of new devices, and system expansions easier. Irrespective of the type of system and the required applications, it is necessary for the installer to have available a map of the premises and a summary idea of the furniture arrangement. It is also important to check that the expectations of the estimate match the reality of the site. The realisation of the system must take into account factors that depend on the installation characteristics of a "BUS" system:

1. Marking of conduits;
2. The type of wiring;
3. Coexistence of cables inside conduits.

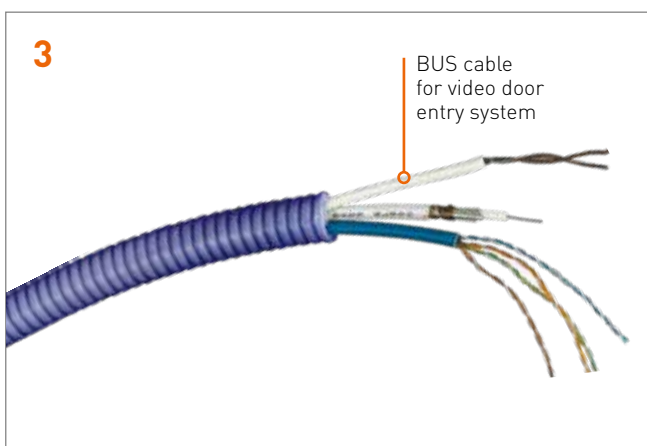
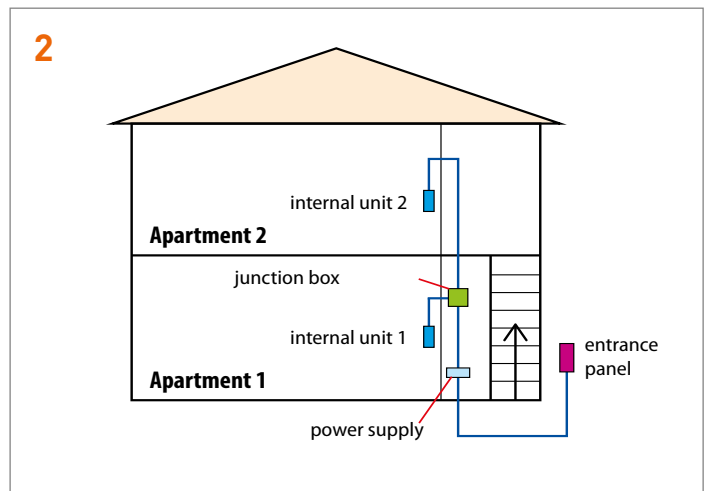
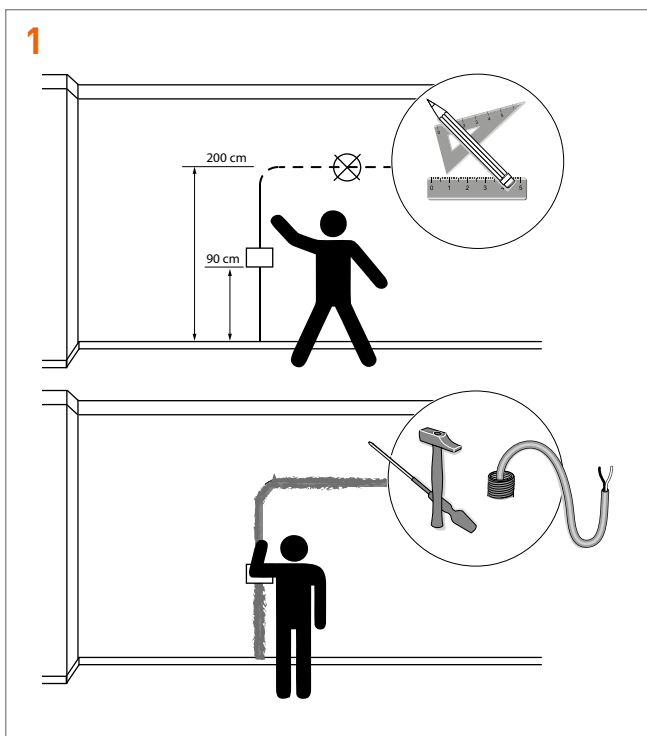



## SELECTION AND POSITIONING OF THE ELECTRICAL PANEL

The arrangement of the electric systems inside the building brings the need to group in one single central point all the active devices (power supply units, interfaces, guard stations, etc.) that contribute to the control and the management of all functions. This position must be sized taking into account the following general rules:

1. allow enough extra space for the installation of further devices that may be needed in the future;
2. install the power supply units in the lowest guard station position, to facilitate the dispersion of any heat;
3. The guard station must be capable of dissipating a power higher than the sum of powers dissipated by all the devices that it will house.

BTicino offers a wide range of guard stations suitable for all kinds of needs, depending on capacity and installation requirements (flush or wall mounted). For installation in new or existing buildings (restorations), on one or several floors, for which the creation of a technical room for the electrical panel of the home is planned, it will be possible to choose either wall or flush mounted control panels or guard stations.

**For the purpose of the calculation of the dissipated power, all BTicino guard stations and control panels meet the requirements of the CEI 23- 51 standard.**

Wall mounted and flush mounted guard stations



## SELV double insulation safety devices

In addition to entrance panels and internal units, the system also requires a few accessories, also connected using the 2 WIRES system.

The "2 wire" system meets the **SELV (Safety Extra Low Voltage)** class, as it is powered with double safety insulation independent power supply units without earth connection, with maximum operating voltage of 25 Vac. (effective), or 60 Vdc, non-sinusoidal.

All BTicino devices have double insulation.

Compliance with SELV classification is only guaranteed subject to **FULL COMPLIANCE** with current installation standards, and with the **GENERAL INSTALLATION RULES** for the individual devices and cables making up the system, outlined by BTicino.



# Installation of entrance panels

## ENTRANCE PANEL HEIGHT

When installing the entrance panel, the pushbutton panel should be positioned at a height of 160 - 165 cm (top wire).

The camera must not be installed facing light sources, or in locations where the area being shot is very backlit.

If this condition cannot be met, the image will show low contrast in the darker areas. This is due to the fact that the brightness is adjusted on the light area of the image.

In order to resolve these problems, we recommend that the camera is installed at a height of 180 cm, instead of

the usual 160-165 cm, with the lens pointing down. This will improve image quality.

In low lit rooms, the installation of an additional light source is recommended.

**Note:** For the use of external pushbutton panels by people with disabilities, the recommended height is 120 - 125 cm (top wire) - ref. (M.D 236/89).

**Recommended installation height, unless different standards are specified.**

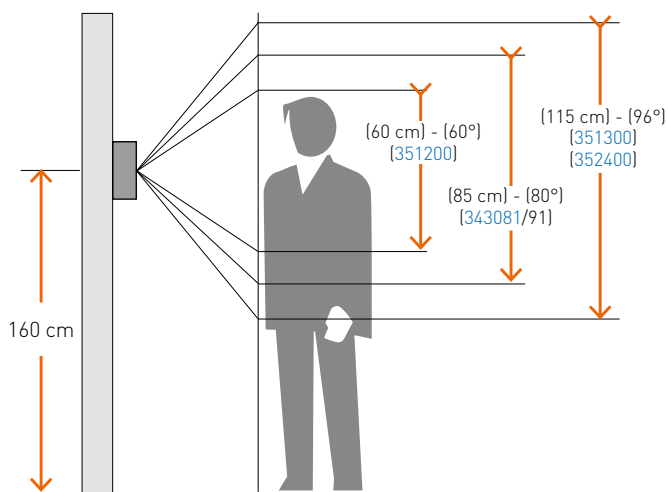
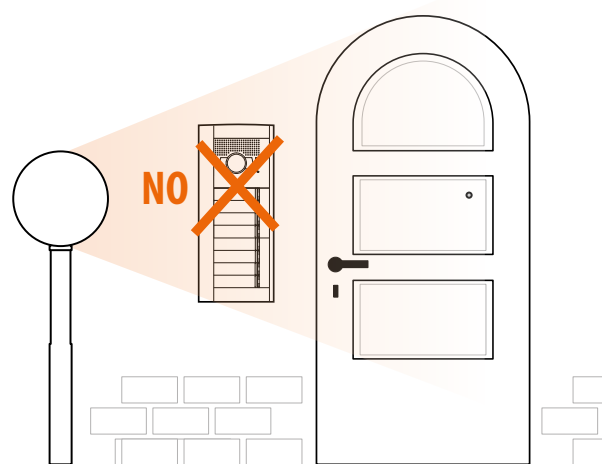
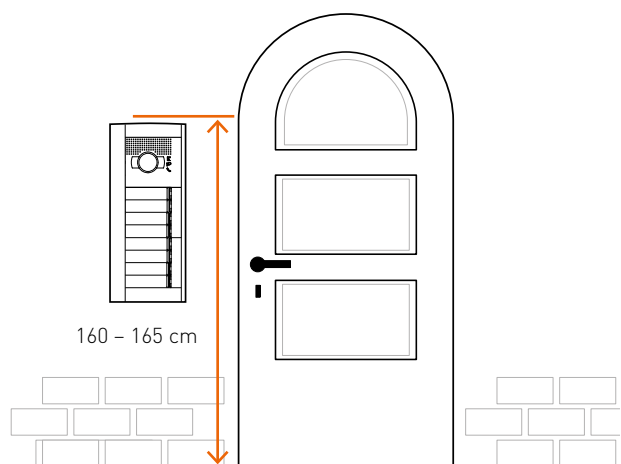

**The use of Sfera and Linea 3000 entrance panels with wide angle camera makes it possible to expand the shooting field, increasing the security of your home.**

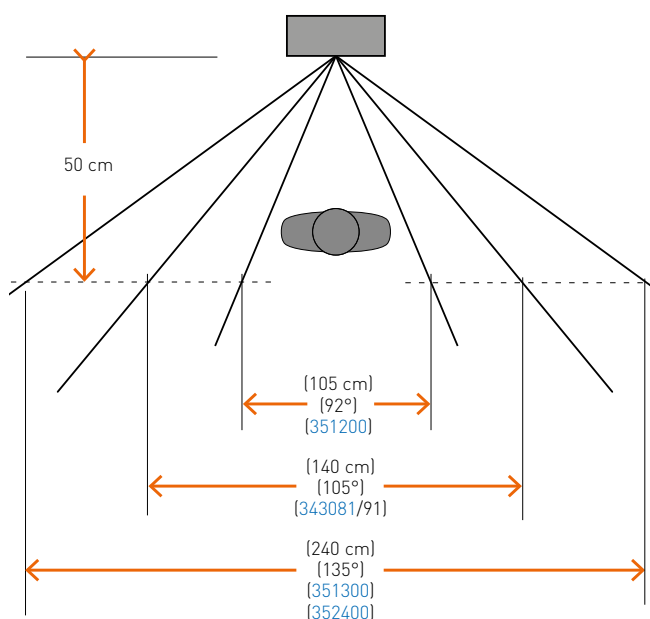

## Installation of internal units and DIN devices

### INTERNAL UNIT HEIGHT

When installing the audio or video internal unit, we recommend a height of 160 - 165 cm (top wire).

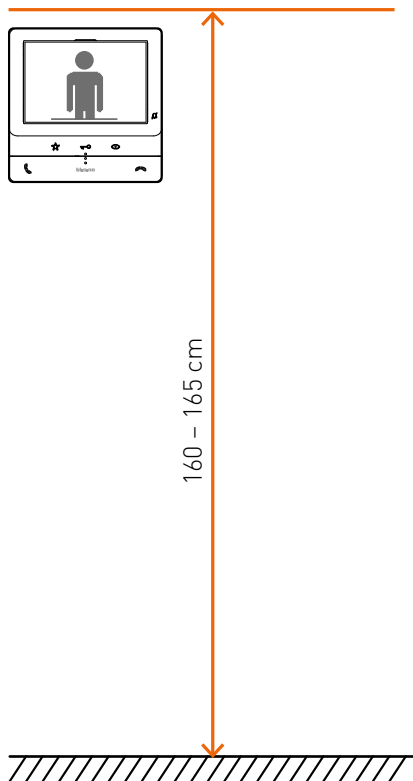

**Note:** For the use of audio or video internal units by people with disabilities, the recommended height is 120 - 125 cm (top wire)

Recommended installation height, unless different standards are specified.

### DIN DEVICES

DIN rail interfaces and devices cannot be installed in wells. An appropriate sealed frame with DIN rail is required for their installation (DIN guard station).

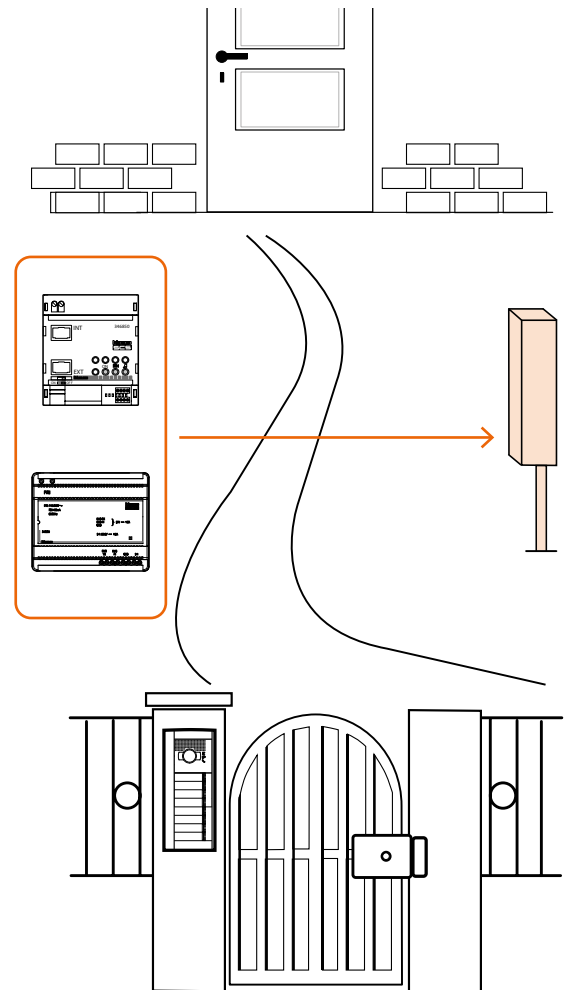

## The cable

The 2 WIRES system is easy to wire. Thanks to the **NON-POLARISED 2 WIRES** wiring of each part of the system, connection is simple, easy and fault-proof. The [336904/336905](#) white BUS-SCS cable has purposely been designed and manufactured for the installation of SCS video door entry systems. This cable is used for the distribution of the power supplies and the operating signals to all BUS devices. It consists of a white external sheath with two brown and brown/white flexible twisted conductors (0.50 mm<sup>2</sup> section). It is sold in a 200 m coil.

Therefore, it is suitable to be used in:

- Free air installation, inside trunking, trays, and conduits;
- Inside masonry walls, in appropriate conduits;
- Underground, in appropriate conduits



Cable channels, trays and conduits must meet the regulatory requirements for the specific type of installation.

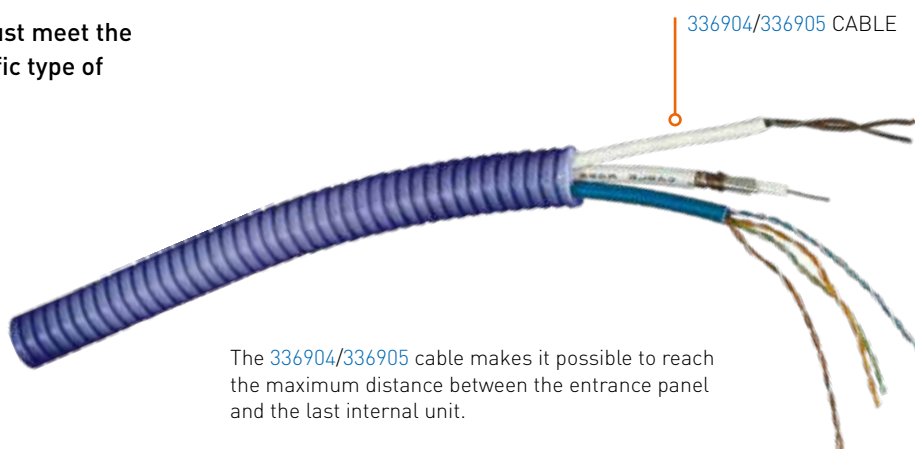

The [336904/336905](#) cable makes it possible to reach the maximum distance between the entrance panel and the last internal unit.

### Cohabitation with other cables

Although the construction of the cable guarantees the necessary electrical insulation for cohabitation with 400 V system cables, there is no guarantee of immunity from electromagnetic disturbance, which may occur when the cable is installed inside the same conduits as the energy cables. It is recommended that the BUS/SCS cable and the power cables are installed in different conduits..









### Cable underground installation

The [336904/336905](#) cable can be installed underground (protected inside appropriate conduits), together with other signal cables, for voltages <50V. Installation of cable [336904/336905](#) together with power cables with energies >50V is strictly forbidden. Failure to comply with the installation requirements shall entitle BTicino to reject all liabilities on the operation of the systems installed.

## THE CABLES THAT CAN BE USED

BTicino recommends the use of the [336904/336905](#) cable for reaching the maximum installation distances, and to ensure a good quality of the video signal.

Other types of cables may be used, provided that the following requirements are met:

CABLES USED					
Type of cable	Item	Can be installed underground	Audio systems	Video systems	
 BTicino twisted cable - section 0.50 mm <sup>2</sup>	<a href="#">336904</a> <a href="#">336905</a>	YES	Recommended	Recommended	
 BTicino twisted cable - section 0.35 mm <sup>2</sup>	<a href="#">L4669</a>	NO	Can be used	Can be used	
 Telephone twisted pair - section 0.28 mm <sup>2</sup> < 1mm <sup>2</sup>		NO	Can be used	Can be used	
 Normal sheathed not twisted cables - section ≥ 0.28 mm <sup>2</sup> < 1mm <sup>2</sup>		NO	Can be used	Can be used	
 Normal sheathed not twisted cables - section = 1mm <sup>2</sup>		NO	Can be used	Can be used	
 BTicino UTP5 cable	<a href="#">032751</a>	NO	Can be used	Can be used	
 UTP5 Multi-pair cable		NO	Can be used	Can be used	
 BTicino multi-pair green cable [pair of cables: green/white-green]	<a href="#">336900</a> <a href="#">336903</a>	NO	Can be used	Can be used	

During the restructurings and refurbishments of old door entry systems, it will be possible to use a pair of existing cables, therefore significantly reducing costs and installation times:



Removal of the existing entrance panel



Use of an existing pair of wires to connect the new 2 WIRES entrance panel

# Physical configuration - general information

Configuring means programming the system; this is done by allocating ID numbers and operating modes to the devices.

This is done by inserting configurators (with numbers from 0 to 9) in the appropriate sockets, using an extractor (3502) found in the configurator bag or purchased separately, or by completing the configuration through the software (recommended).

When no configurator is inserted, the configuration is zero.

In the system there are two different numbering systems, to identify the entrance panels (EP) and the internal units (IU) respectively.

The numbering system of the entrance panels (0-95) is normally indicated with P, while the internal unit address (0-99) is normally indicated with N.

In addition to the P address, on the entrance panels it is also necessary to configure the N address of the internal unit from which to start to call.

In addition to the N address, on each internal unit it is also necessary to configure in P the associated entrance panel, which is the entrance panel to which the door lock and auto-switching on command will be sent when the internal unit is off.

*Should it become necessary to change the configuration of a device, in addition to removing the configurators also disconnect the power supply to the whole system, wait one minute and then reconnect the power supply. There are also specific configurations for every device, which are discussed in details in the technical data sheets of the individual items.*

The configurators can be purchased in kit

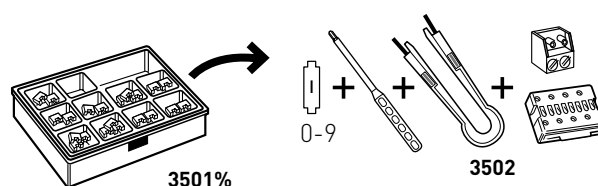

or individually

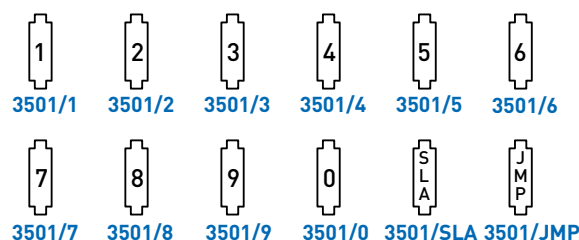

## Example of a configured system and its operation

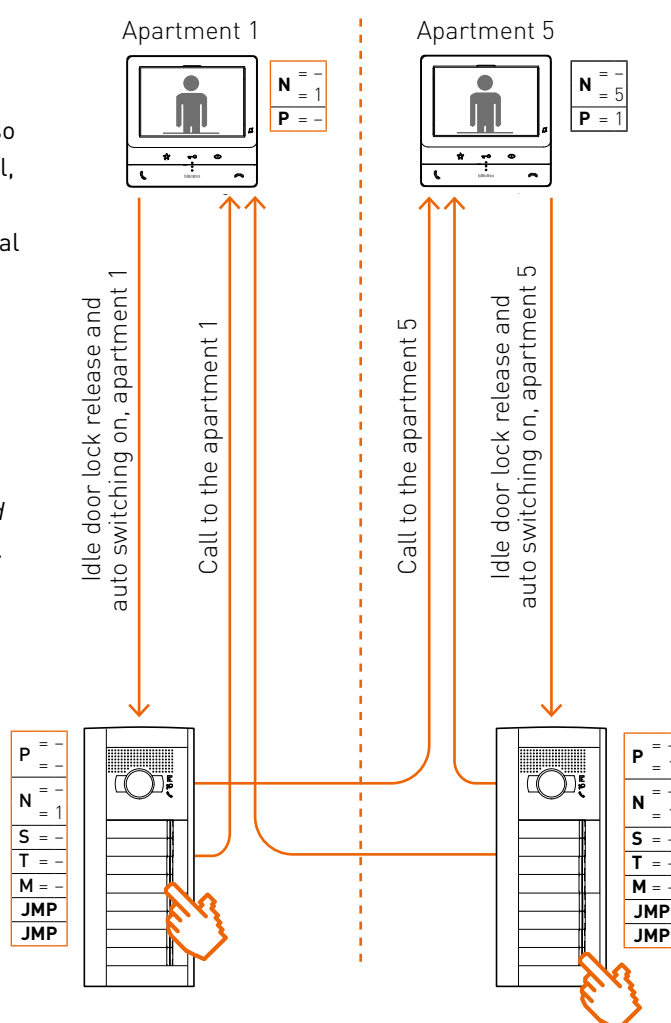

## Configuration of entrance panels

All the entrance panels must be physically configured by inserting configurators. Sfera entrance panels can also be configured in advanced mode (using the PC and the specific TiSferaDesign configuration software).

**CAUTION :** the configuration of the device completed using physical configurators CANNOT BE MODIFIED in advanced mode.

The sockets of the internal units where the configurators must be inserted are normally the following:

### P - entrance panel number

The configurator in socket P of the EP assigns to this a recognition number inside the system. The numbering of the entrance panels must always start from P=0. The entrance panel configured with P=0 must be a common (or main) entrance panel.

### N - call number

Assigns the correspondence between the entrance panel pushbuttons and the audio internal units or video internal units. In common entrance panels made using pushbutton modules, 1 must be inserted in N of the speaker module.

### T - door lock time control

The configuration of T defines the door lock release activation time.

### S - type of call signal

The configuration of S determines the call tone of internal units. One can thus differentiate the calls from different entrance panels.

### Only for Sfera New/Robur entrance panels:

#### M - enabling/disabling of call tones and door lock release tones, and management of night lighting always ON

The M configurations gives the possibility of managing the entrance panel call and door lock release tones . It also gives the possibility of enabling night backlighting always ON (light sensor disabled).

#### J1 - activation of call pushbutton columns

The J1 configurator gives the possibility of managing the Call pushbuttons of the speaker module as follows:

**JMP CONNECTED** = Only the right pushbutton column is enabled

**JMP DISCONNECTED** = Both pushbutton columns are enabled (right + left)

#### J2 - additional EP power supply

Configurator J2 gives the possibility of enabling the additional power supply (1-2) of the speaker module in the following mode :

**JMP CONNECTED** = Additional power supply disabled

**JMP DISCONNECTED** = Additional power supply enabled

**NOTE:** the above are general indications. We recommend that you refer to the device configuration sections in the corresponding technical data sheets for the individual devices.

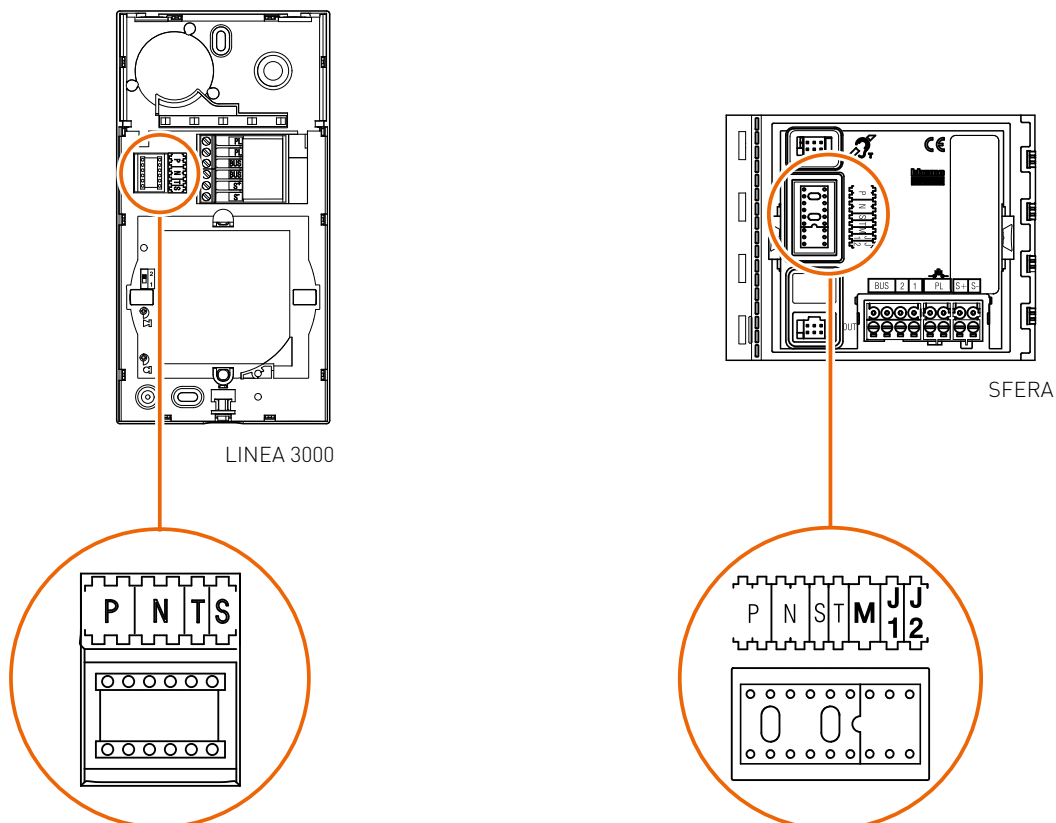



## ADVANCED CONFIGURATION OF THE SFERA NEW/ROBUR ENTRANCE PANELS

The Sfera New/Robur entrance panels may be configured in advanced mode using the PC and the specific configuration software (TiSferaDesign).

The advanced configuration offers a high level of customisation of the device in terms of: flexible menu composition, text customisation, apartment call / direct guard station call (if present) key position customisation. Residents' contact address book, including the details of the door badges assigned and the access codes.

For the connection to the PC, use a standard USB - mini USB cable. The software configures, programs, and updates the device Firmware. Sfera entrance panels have mini USB front connection, making it possible to carry out all operations without having to remove the pushbutton panel.

The TiSferaDesign programming software can be downloaded free of charge from the website:

[www.homesystems-legrandgroup.com](http://www.homesystems-legrandgroup.com)

**CAUTION:** for correct functionality, it is recommended to carry out all the configuration operations with the pushbutton panel powered by BUS.



## Internal unit configuration

All the internal units (audio and video) must be physically configured by inserting configurators. Classe 300EOS video internal units can also be configured in advanced mode (directly from the touch screen), through the appropriate configuration section available on the device.

**CAUTION:** the device configuration made with physical configurators CANNOT BE MODIFIED using the menu.

The sockets of the internal units where the configurators must be inserted are normally the following:

### N - internal unit number

The configurators connected to the N sockets of the internal units assign an identification number within the system to each audio and video internal unit. The internal units must be configured in progressive order.

### P – entrance panel association

The configurators connected to the P sockets of the internal units identify the associated EP, which is the first entrance panel that switches itself on when the pushbutton is pressed the first time, as well as which door lock is activated when pressing the door lock pushbutton while the audio internal unit is idle.

### M / MOD – operating mode

The configurators in the M / MOD sockets of the internal units assign the operating modes to the configurable device keys.

### J1 – additional power supply

The (JMP) configurator in J1 is used to enable/disable the additional power supply according to the following mode:

**JMP CONNECTED** = Additional power supply disabled

**JMP DISCONNECTED** = Additional power supply enabled

### J2 - MASTER/SLAVE function

The (JMP) configurator in J2 is used to activate/deactivate the MASTER / SLAVE function according to the following mode:

**JMP CONNECTED** = MASTER

**JMP DISCONNECTED** = SLAVE

**NOTE:** the above are general indications. We recommend that you refer to the device configuration sections in the corresponding technical data sheets for the individual devices.

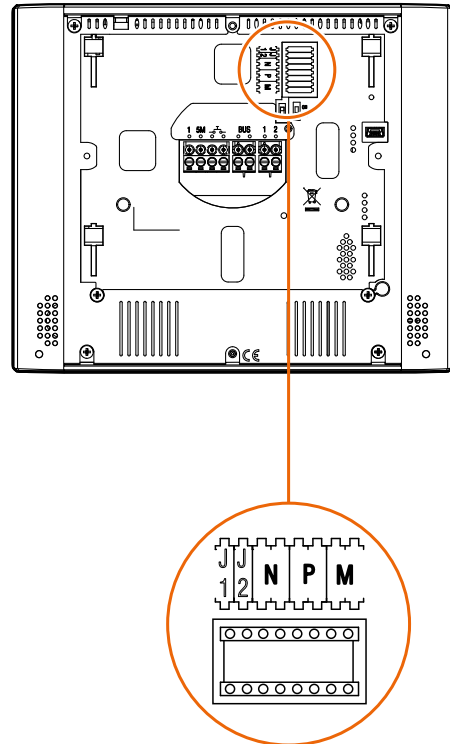



**AUDIO SYSTEMS**

## Audio systems

### GENERAL LIMITS

Below are the maximum limits that can be reached by an AUDIO 2 WIRES system when using apartment interfaces (346850) and system expansion interfaces (346851).

<b>96</b>	Entrance panels
<b>39</b>	Risers with independent audio
<b>100</b>	Apartments with interface 346851 on the riser
<b>3900</b>	Apartments (100 interfaces 346850 for riser)
<b>3</b>	Internal units for each apartment
<b>5</b>	Internal units for each apartment (with interface 346850)
<b>20</b>	Internal units for each apartment (with interface 346850 + interfaces 346851)

### AUDIO 2 WIRES WIRING

2 WIRES systems are obtained by shunting the 2 WIRES BUS to connect internal units and entrance panels.

The connection of the devices can be at any position in the system. Twisted cables are not necessary when connecting the devices.

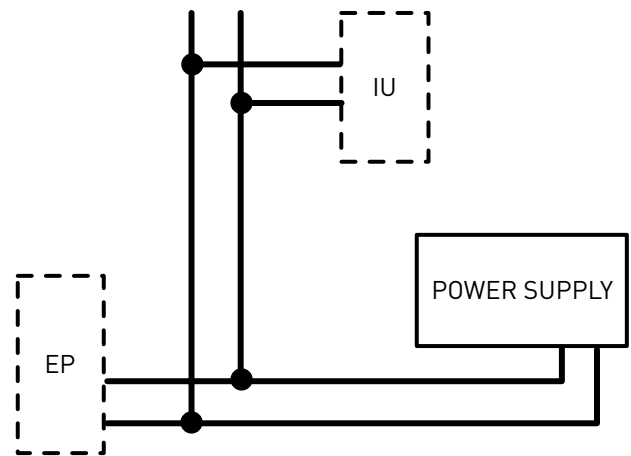

Audio system connection mode

## AUDIO SYSTEMS

### EXAMPLE OF TYPE 1 SYSTEM

To complete an audio system, it is necessary to purchase:

- ▶ Entrance panel
- ▶ Internal unit
- ▶ Power supply
- ▶ Configurators

**Notes:**

- connections with 2 non-polarised wires;
- devices that can be connected at any positions on the system.

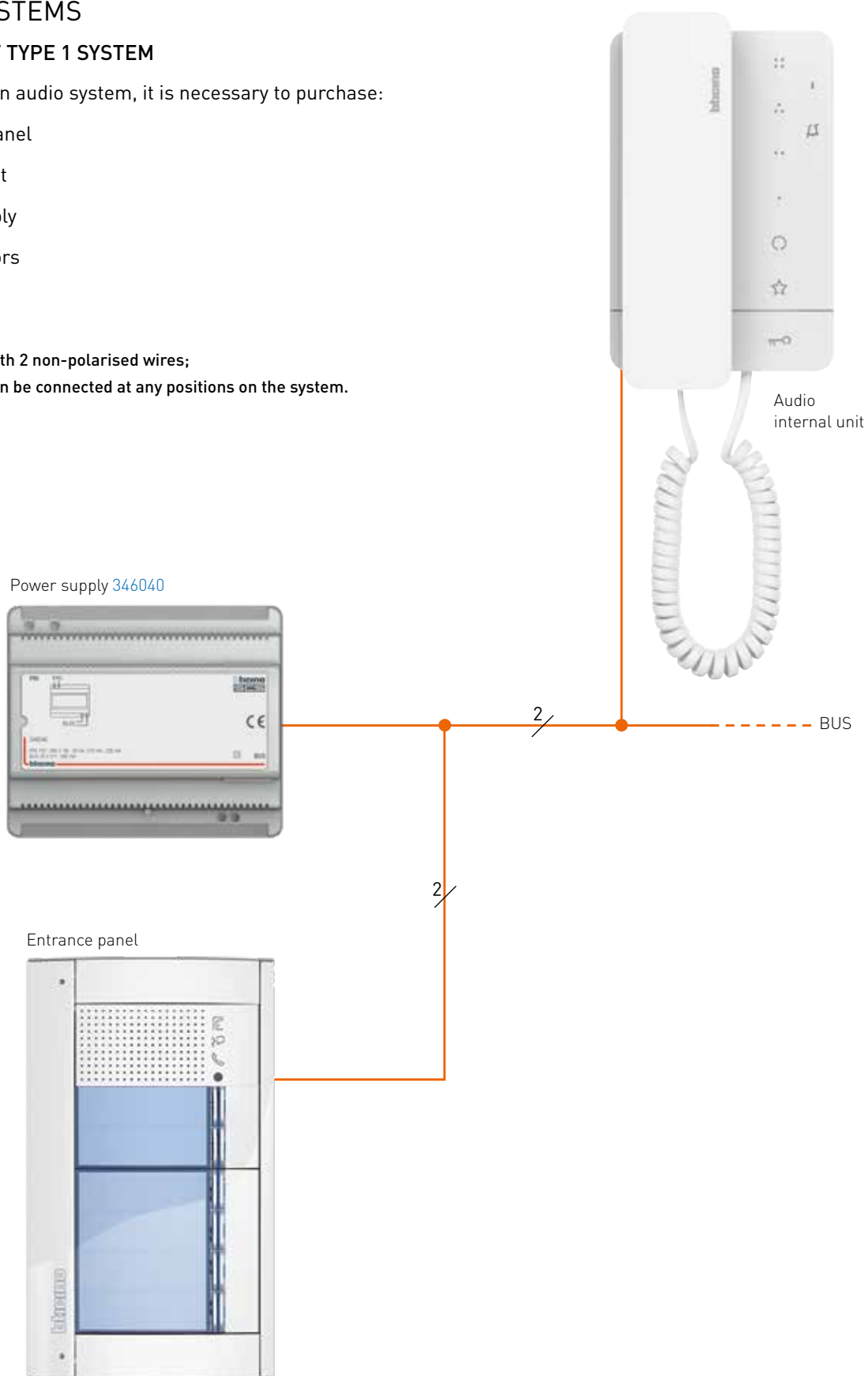

# Audio systems

## EXAMPLE OF TYPE 2 SYSTEM

To complete an audio system, it is necessary to purchase:

- ▶ Entrance panel
- ▶ Internal unit
- ▶ Power supply
- ▶ Configurators

**Notes:**

- connections with 2 non-polarised wires;
- devices that can be connected at any positions on the system.

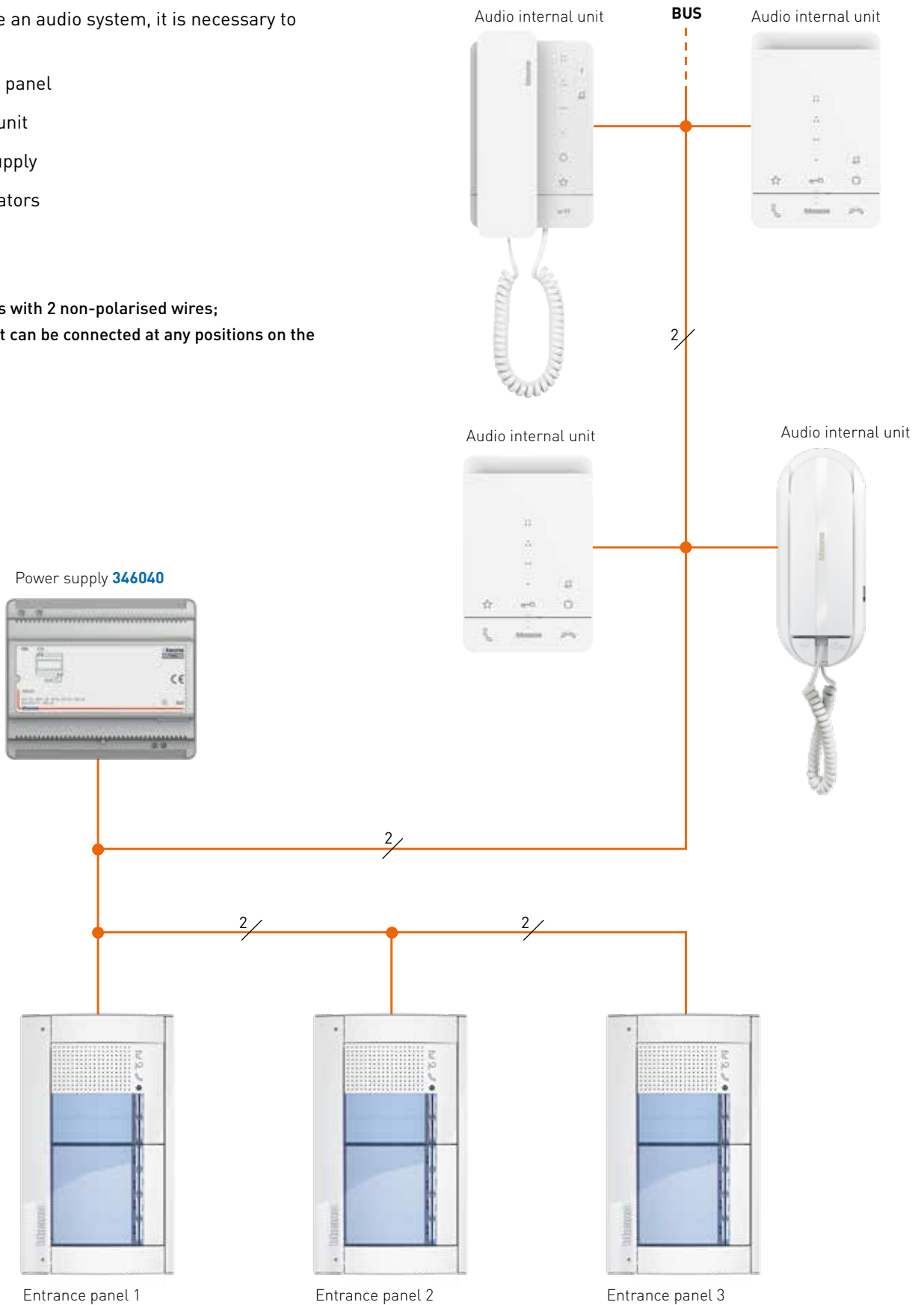

## POSSIBLE AUDIO SYSTEMS

### AUDIO SYSTEM WITH POWER SUPPLY 346040

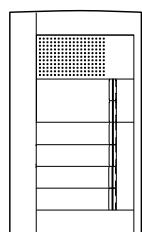

Entrance Panel

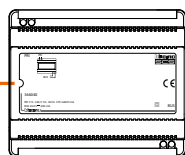

Power supply 346040

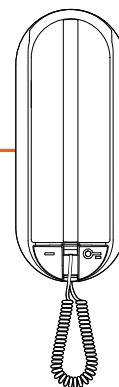

Audio internal unit

- (only 1 entrance panel)
- For the different installation combinations refer to the general installation rules.

MAX 72 INTERNAL UNITS

### AUDIO SYSTEM WITH POWER SUPPLY 346050

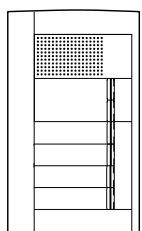

Entrance Panel

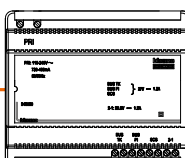

Power supply 346050



Audio internal unit

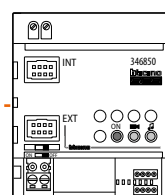

Apartment interface

- (only 1 entrance panel)
- For the different installation combinations refer to the general installation rules.

MAX 100 INTERNAL UNITS OR APARTMENT INTERFACES

### EXAMPLES OF AUDIO SYSTEMS:

Up to **100** internal units maximum may be connected in audio system with **1** entrance panel. For example it is possible to connect:

- **100** Apartments with 1 IU (or apartment interface 346850)
- **80** Apartments with 1 IU (or apartment interface 346850); **10** Apartments with 2 IU ( $80 + (10 \times 2) = 100$ ).
- **71** Apartments with 1 IU (or apartment interface 346850), **10** Apartments with 2 IU, 2 apartments with 3 IU and 1 actuator for generic loads ( $71 + (10 \times 2) + (2 \times 3) + 3 = 100$ ).

## Audio systems

### POSSIBLE COMBINATIONS – AUDIO SYSTEMS

#### AUDIO SYSTEMS MAX. 72 INTERNAL UNITS (with system power supply 346040)

SFERA ENTRANCE PANELS WITH KEY MODULES / EXPANSION KEY 346993 / UNIVERSAL PORTER 346991				
Max. No. of entrance panels	SFERA		SFERA + KEY EXPANSION 346993	UNIVERSAL PORTER 346991
	Max. No. of internal units	Max. No. of nameplate modules	Max. No. of internal units	Max. No. of internal units with 346991 + 346992
1	72	1	72	56
2	60	2	64	56
3	52	3	56	40
4	44	4	48	32
1 main + 2 secondary	52	3	64	48
1 main + 3 secondary	48	4	56	48
1 main + 4 secondary	40	5	48	48

#### NOTES:

- All the combinations are calculated with entrance panels (both main and secondary) with modules with 8 call keys.
- The main entrance panels are those that can call all the internal units, while secondary entrance panels can only call some internal units.
- Systems with "main and secondary" entrance panels HAVE NO independent audio (this means that only 1 communication session at the time is guaranteed).
- The number of call keys for each secondary EP is calculated by dividing the total number of IU that can be installed by the total number of secondary EP (secondary EP consisting of modules with 8 keys, like the main EP).
- In sizing the systems, it will be necessary to also take into account the introduction of other components: these will take away further IU from the system:
  - for each **additional plate module** (in addition to the already indicated ones), it will be necessary to **remove 1 IU**;
  - for each generic load **actuator 346210** or **call repeater**, it will be necessary to **remove 1 IU**;
  - for each **door lock actuator 346230**, it will be necessary to **remove 3 IU**;
  - for each **floor call interface 346833**, it will be necessary to **remove 1 IU**;
  - for each **special control**, it will be necessary to **remove 1 IU**.



In view of the many installation possibilities, the values shown on the table are only indicative.  
For correct sizing of the system, we recommend the use of the [YouDiagram](#) software -  
which can be downloaded free of charge from [www.bticino.com](http://www.bticino.com).



## POSSIBLE COMBINATIONS – AUDIO SYSTEMS

**AUDIO SYSTEMS MAX. 100 INTERNAL UNITS (with system power supply 346050)**

SFERA ENTRANCE PANELS WITH KEY MODULES / EXPANSION KEY 346993 / UNIVERSAL PORTER 346991				
Max. No. of entrance panels	SFERA		SFERA + KEY EXPANSION 346993	UNIVERSAL PORTER 346991
	Max. No. of internal units	Max. No. of nameplate modules	Max. No. of internal units	Max. No. of internal units with 346991 + 346992
1	100	1	96	100 (*)
2	92	2	96	64 (*)
3	84	3	96	50
4	76	4	96	38
5	64	5	96	30
6	56	6	88	22
1 main + 2 secondary	92	1	96	76
1 main + 3 secondary	84	1	96	48
1 main + 4 secondary	76	1	96	48

(\*) in systems with more than 56 keys, allow for 2 separate pushbutton panels.

### NOTES:

- All the combinations are calculated with entrance panels (both main and secondary) with modules with 8 call keys.
- The main entrance panels are those that can call all the internal units, while secondary entrance panels can only call some internal units.
- Systems with "main and secondary" entrance panels HAVE NO independent audio (this means that only 1 communication session at the time is guaranteed).
- The number of call keys for each secondary EP is calculated by dividing the total number of IU that can be installed by the total number of secondary EP (secondary EP consisting of modules with 8 keys, like the main EP).
- In sizing the systems, it will be necessary to also take into account the introduction of other components: these will take away further IU from the system:
  - for each **additional plate module** (in addition to the already indicated ones), it will be necessary to **remove 1 IU**;
  - for each generic load **actuator 346210** or **call repeater**, it will be necessary to **remove 1 IU**;
  - for each **door lock actuator 346230**, it will be necessary to **remove 3 IU**;
  - for each **floor call interface 346833**, it will be necessary to **remove 1 IU**;
  - for each **special control**, it will be necessary to **remove 1 IU**.



In view of the many installation possibilities, the values shown on the table are only indicative. For correct sizing of the system, we recommend the use of the [YouDiagram](#) software - which can be downloaded free of charge from [www.bticino.com](http://www.bticino.com).

## Audio systems

### POSSIBLE COMBINATIONS – AUDIO SYSTEMS

#### AUDIO SYSTEMS MAX. 100 INTERNAL UNITS (with system power supply **346050**)

SFERA ENTRANCE PANELS WITH DISPLAY MODULES				
	SFERA includes: speaker module (351100) + display module (352500)	SFERA includes : speaker module (351100) + display module (352500) + keypad module (353000)		
Max. No. of entrance panels	Max. No. of internal units	Max. No. of internal units	Max. No. of name-plate modules	Max. No. of internal units without nameplate modules
1	100	100	13	100
2	100	80	20	100
3	100	64	24	95
4	95	48	24	80
5	85	32	20	60
6	75	24	18	45
1 main + 2 secondary with pushbuttons	100	88	11	100

#### NOTES:

- Each nameplate module manages 8 names/calls;
- The main entrance panels are those that can call all the internal units, while secondary entrance panels can only call some internal units.
- Systems with "main and secondary" entrance panels HAVE NO independent audio (this means that only 1 communication session at the time is guaranteed).
- The number of call keys for each secondary EP is calculated by dividing the number of IU that can be installed by the total number of secondary EP (secondary EP consisting of modules with 8 keys).
- In sizing the systems, it will be necessary to also take into account the introduction of other components: these will take away further IU from the system:
  - for each **additional plate module** (in addition to the already indicated ones), it will be necessary to **remove 1 IU**;
  - for each generic load **actuator 346210** or **call repeater**, it will be necessary to **remove 1 IU**;
  - for each **door lock actuator 346230**, it will be necessary to **remove 3 IU**;
  - for each **floor call interface 346833**, it will be necessary to **remove 1 IU**;
  - for each **special control**, it will be necessary to **remove 1 IU**.



In view of the many installation possibilities, the values shown on the table are only indicative. For correct sizing of the system, we recommend the use of the [YouDiagram](#) software - which can be downloaded free of charge from [www.bticino.com](http://www.bticino.com).

# System performance - audio systems

The following pages give a general indication of the maximum distances that can be reached depending on the type of cable used.

For situations or installation conditions other than the ones listed in this document, the current consumptions can be calculated using the YouDiagram software (which can be downloaded free of charge from: [www.professionisti.bticino.it](http://www.professionisti.bticino.it))

## AUDIO SYSTEMS- MAX. 72 INTERNAL UNITS

The device connection is non polarised.

The use of conductors with sections other than the prescribed ones does not guarantee correct performance of the system.

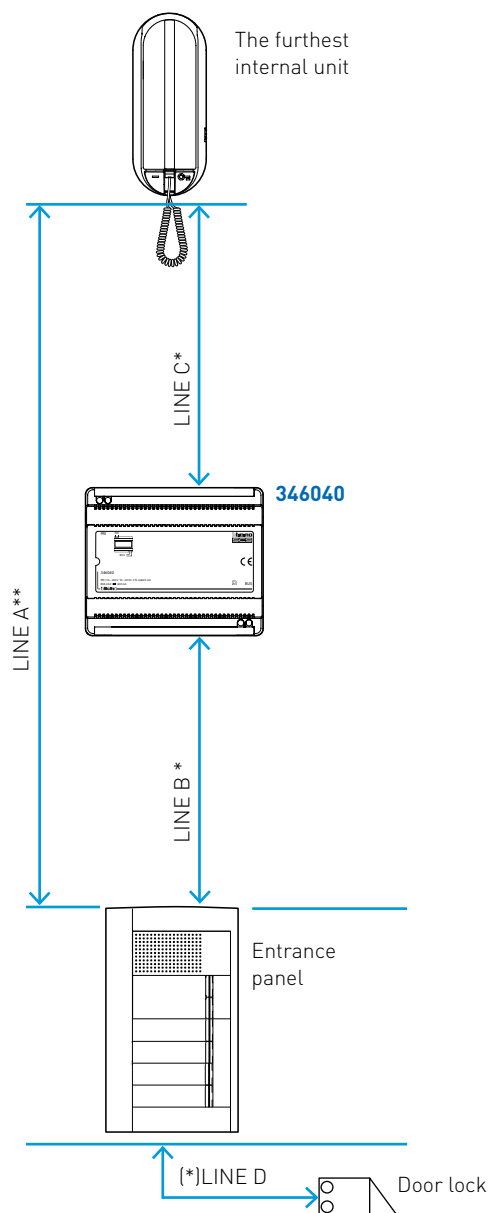

System made with audio modules:

- SFERA
- Power supply 346040

System with existing pushbutton panel:

- Universal speaker unit 346991
- Additional pushbutton module 346992
- Power supply 346040

(\*) max variable distance

(\*\*) Maximum distance variable according to the number of installed devices and their absorption. Max 1000 meters with cables of 1mm<sup>2</sup> section. In general Line A = Line B + Line C

### MAX DISTANCE - LINE C - FURTHEST INTERNAL UNIT - POWER SUPPLY

Cable section mm <sup>2</sup>	0.28 mm <sup>2</sup>	BTicino cable L4669 0.35 mm <sup>2</sup>	BTicino cable 336904 0.5 mm <sup>2</sup>	1 mm <sup>2</sup>
72 Internal units	105 m	115 m	165 m	335 m
60 Internal units	125 m	135 m	195 m	395 m
52 Internal units	140 m	155 m	220 m	450 m
44 Internal units	160 m	170 m	240 m	490 m

### MAX DISTANCE - LINE B - POWER SUPPLY - ENTRANCE PANEL

Cable section mm <sup>2</sup>	0.28 mm <sup>2</sup>	BTicino cable L4669 0.35 mm <sup>2</sup>	BTicino cable 336904 0.5 mm <sup>2</sup>	1 mm <sup>2</sup>
72 Pushbuttons	130 m	140 m	190 m	365 m
60 Pushbuttons	135 m	145 m	200 m	385 m
52 Pushbuttons	145 m	155 m	225 m	435 m
44 Pushbuttons	155 m	175 m	235 m	455 m

### MAX DISTANCE - LINE D - SPEAKER MODULE - DOOR LOCK

Cable section mm <sup>2</sup>	0.28 mm <sup>2</sup>	BTicino cable L4669 0.35 mm <sup>2</sup>	BTicino cable 336904 0.5 mm <sup>2</sup>	1 mm <sup>2</sup>
S+ S- clamps	30 m	30 m	50 m	100 m

**NOTE:** with EP made using universal speaker unit 346991, manage the door lock control using actuator 346230.

# System performance - audio systems

## AUDIO SYSTEMS - MAX. 100 INTERNAL UNITS

The device connection is non polarised.

The use of conductors with sections other than the prescribed ones does not guarantee correct performance of the system.

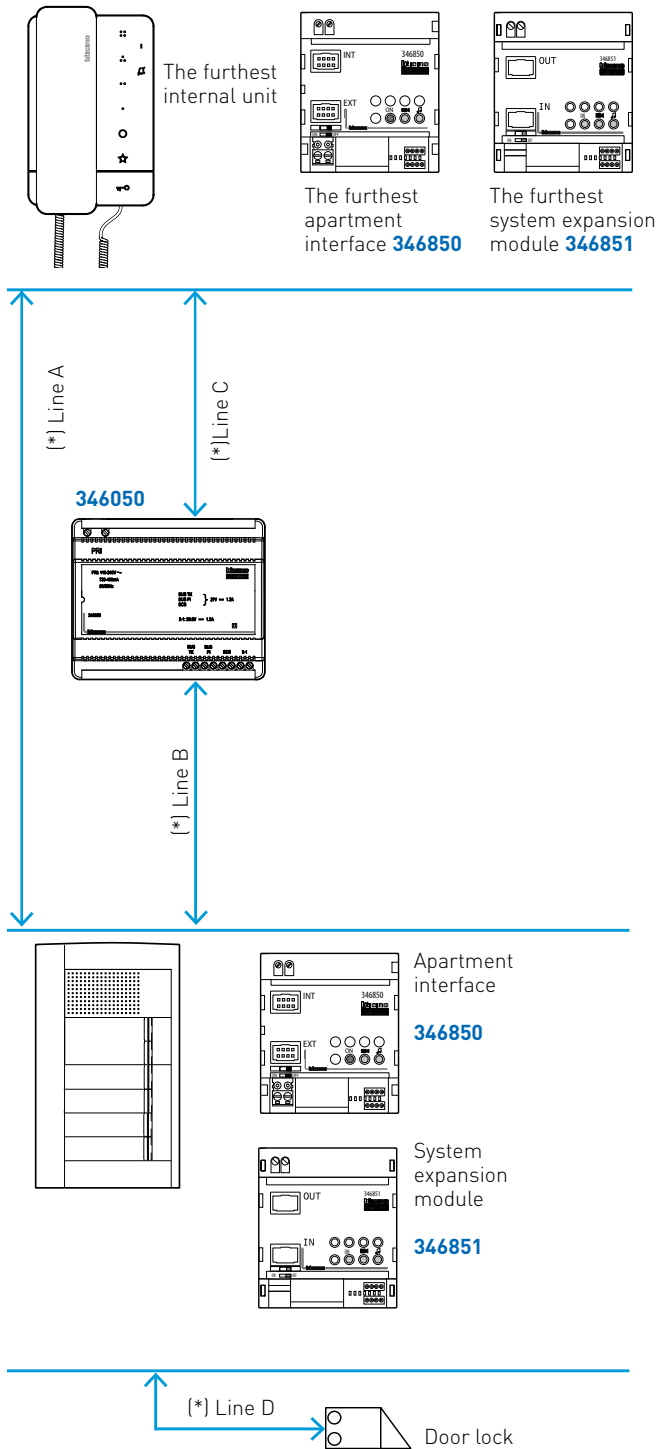

System made with AUDIO modules:

- SFERA
- Power supply 346050

System with existing pushbutton panel:

- universal speaker unit 346991
- additional pushbutton module 346992
- Power supply 346050

The tables show the distances for an audio system with at least one interface (in bold), and for the audio system without interfaces.

### MAX DISTANCE - LINE C - FURTHEST INTERNAL UNIT - POWER SUPPLY

Cable section mm <sup>2</sup>	0.28 mm <sup>2</sup>		BTicino cable L4669 0.35 mm <sup>2</sup>		BTicino cable 336904 0.5 mm <sup>2</sup>		1 mm <sup>2</sup>	
	100 m	100 m	110 m	110 m	150 m	150 m	320 m	320 m
100 Internal units	100 m	100 m	110 m	110 m	150 m	150 m	320 m	320 m
66 Internal units	120 m	120 m	130 m	130 m	190 m	190 m	380 m	380 m
50 Internal units	140 m	150 m	150 m	160 m	200 m	250 m	450 m	450 m
26 Internal units	140 m	180 m	150 m	190 m	200 m	320 m	450 m	560 m

### MAX DISTANCE - LINE B - POWER SUPPLY - ENTRANCE PANEL

Cable section mm <sup>2</sup>	0.28 mm <sup>2</sup>		BTicino cable L4669 0.35 mm <sup>2</sup>		BTicino cable 336904 0.5 mm <sup>2</sup>		1 mm <sup>2</sup>	
	100 m	100 m	110 m	110 m	180 m	180 m	310 m	310 m
100 pushbuttons	100 m	100 m	110 m	110 m	180 m	180 m	310 m	310 m
66 pushbuttons	130 m	130 m	140 m	110 m	200 m	240 m	420 m	420 m
50 pushbuttons	140 m	150 m	150 m	160 m	200 m	250 m	450 m	450 m
26 pushbuttons	140 m	200 m	150 m	210 m	200 m	290 m	450 m	580 m

Line A = Line B+Line C with Line A max = 1000m without interfaces 346850 and 346851

### MAX DISTANCE - LINE A WITH INTERFACES 346850 AND 346851

Cable section mm <sup>2</sup>	0.28 mm <sup>2</sup>		BTicino cable L4669 0.35 mm <sup>2</sup>		BTicino cable 336904 0.5 mm <sup>2</sup>		1 mm <sup>2</sup>	
	140 m	140 m	150 m	150 m	200 m	200 m	450 m	450 m
100 Internal units	140 m	140 m	150 m	150 m	200 m	200 m	450 m	450 m

### MAX DISTANCE - LINE D - SPEAKER MODULE - DOOR LOCK

Cable section mm <sup>2</sup>	0.28 mm <sup>2</sup>		BTicino cable L4669 0.35 mm <sup>2</sup>		BTicino cable 336904 0.5 mm <sup>2</sup>		1 mm <sup>2</sup>	
	30 m	30 m	30 m	30 m	50 m	50 m	100 m	100 m
S + S- clamps	30 m	30 m	30 m	30 m	50 m	50 m	100 m	100 m

**NOTE:** with EP made using universal speaker unit 346991, manage the door lock control using actuator 346230.

[\*] max variable distance



VIDEO SYSTEMS

## Video systems

### GENERAL LIMITS

Below are the maximum limits that can be reached by an VIDEO 2 WIRES system when using apartment interfaces (346850) and system expansion interfaces (346851).

- 96** Video entrance panels
- 39** Risers with independent audio
- 100** Apartments with interface 346851 on the riser
- 3900** Apartments (100 interfaces 346850 for riser)
- 15** Entrance panels or cameras for apartment (16 in the one-family system)
- 3** Internal units for each apartment
- 5** Internal units for each apartment (with interface 346850)
- 10** Internal units for each apartment (with interface 346850 + interfaces 346851)

**CAUTION:** for info regarding the correct installation and use refer to the technical sheets of the individual devices.

The distance between the entrance panel and the furthest internal unit must not exceed 200 metres.

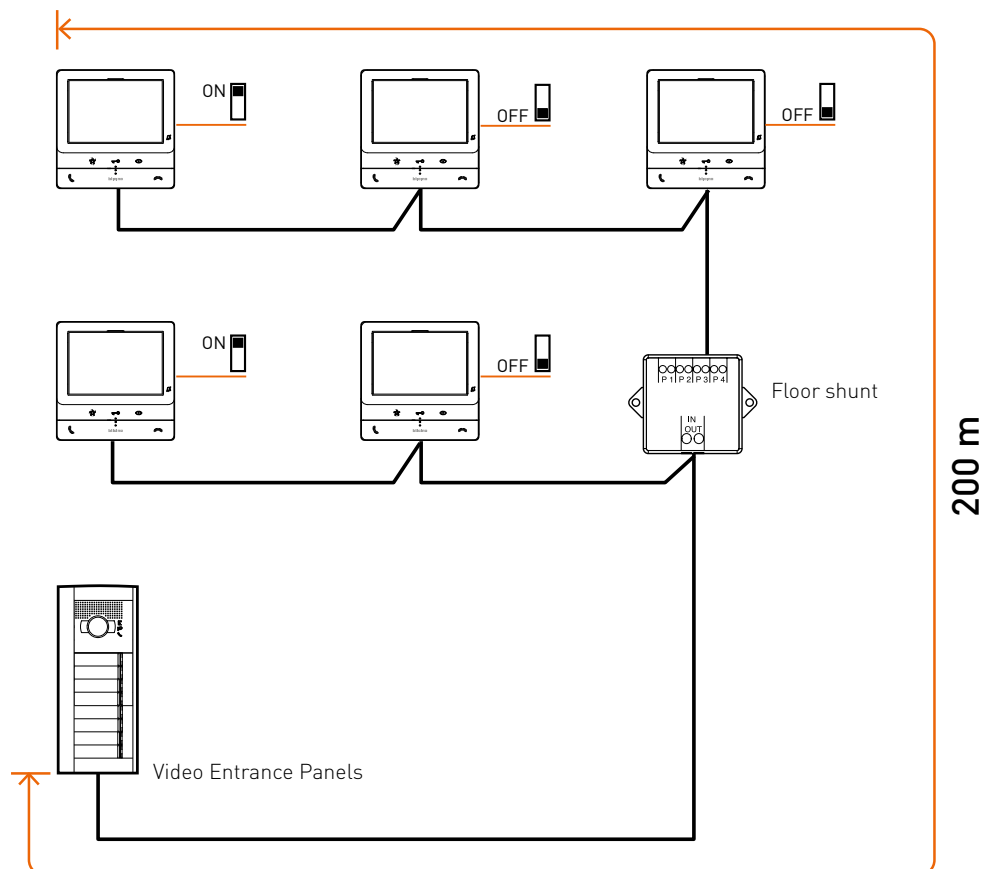

## VIDEO 2 WIRES WIRING

2 WIRES video systems can be installed with star wiring using floor shunt [346841](#); in-out or mixed wiring is also possible as an alternative.

### STAR WIRING

Star wiring is completed by connecting the individual apartment to an output of floor shunt [346841](#).

Each line must be terminated by positioning the microswitch of the last device to ON.

Star wiring is particularly suited to multifamily systems with several dwellings on the same floor, and to multifamily systems where maximum distance between entrance panel and all internal units is required.

Up to 3 internal units can be connected to each output of the floor shunt.

Allocate an output of the floor shunt to each internal unit with simultaneous switching on, or installed with tabletop base.

### IN-OUT WIRING

- IN-OUT wiring is completed directly on the clamp of the devices connected to the system. Each riser must be terminated by positioning the microswitch of the last internal unit to ON.

IN-OUT wiring is particularly indicated for one and two family systems, and for vertical or horizontal multi-family systems (dwellings in rows).

#### STAR wiring

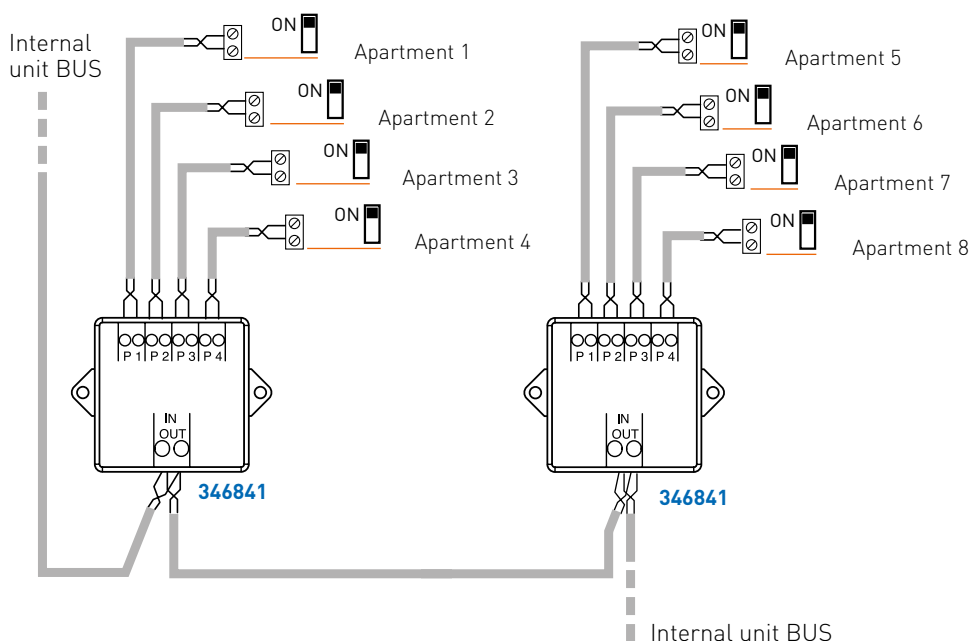

#### IN-OUT wiring

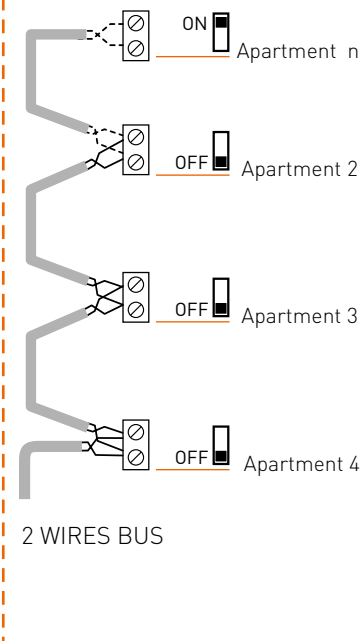

## Video systems

### VIDEO 2 WIRES WIRING

#### MIXED WIRING

The two previously described wiring methods can be combined for the realisation of more complex systems. Mixed wiring (IN-OUT and Star) makes it possible to wire systems in a way that meets most installation requirements.

The outputs of the floor shunts may be used to connect an individual device, or to generate an apartment line (on which it will be possible to connect up to 3 devices without apartment interface [346850](#)).

Using the IN-Out method, it will be possible to connect floor shunts or internal units to the internal unit BUS.

The allocation of the internal units to the apartments is completed through the configuration.

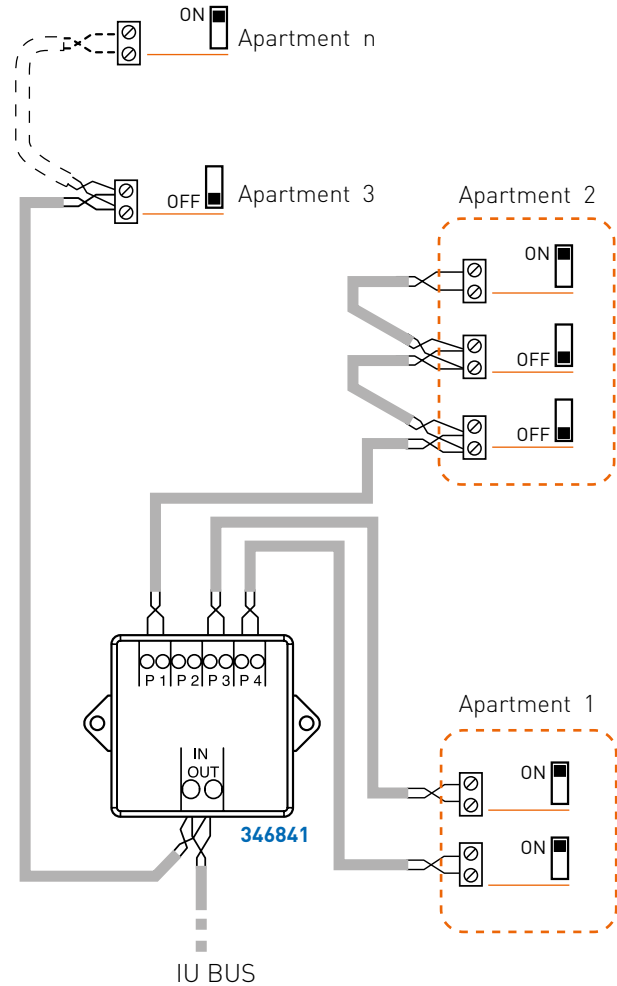



## VIDEO SYSTEMS

### EXAMPLE OF A SYSTEM WITH POWER SUPPLY 346050

**Notes:**

- Connection with 2 non-polarised wires
- A maximum of 3 connections are possible on the (IU BUS ) and (TK BUS ) clamps of power supply unit 346050, (2 entrance panels + 1 riser, or 1 entrance panel + 2 risers).

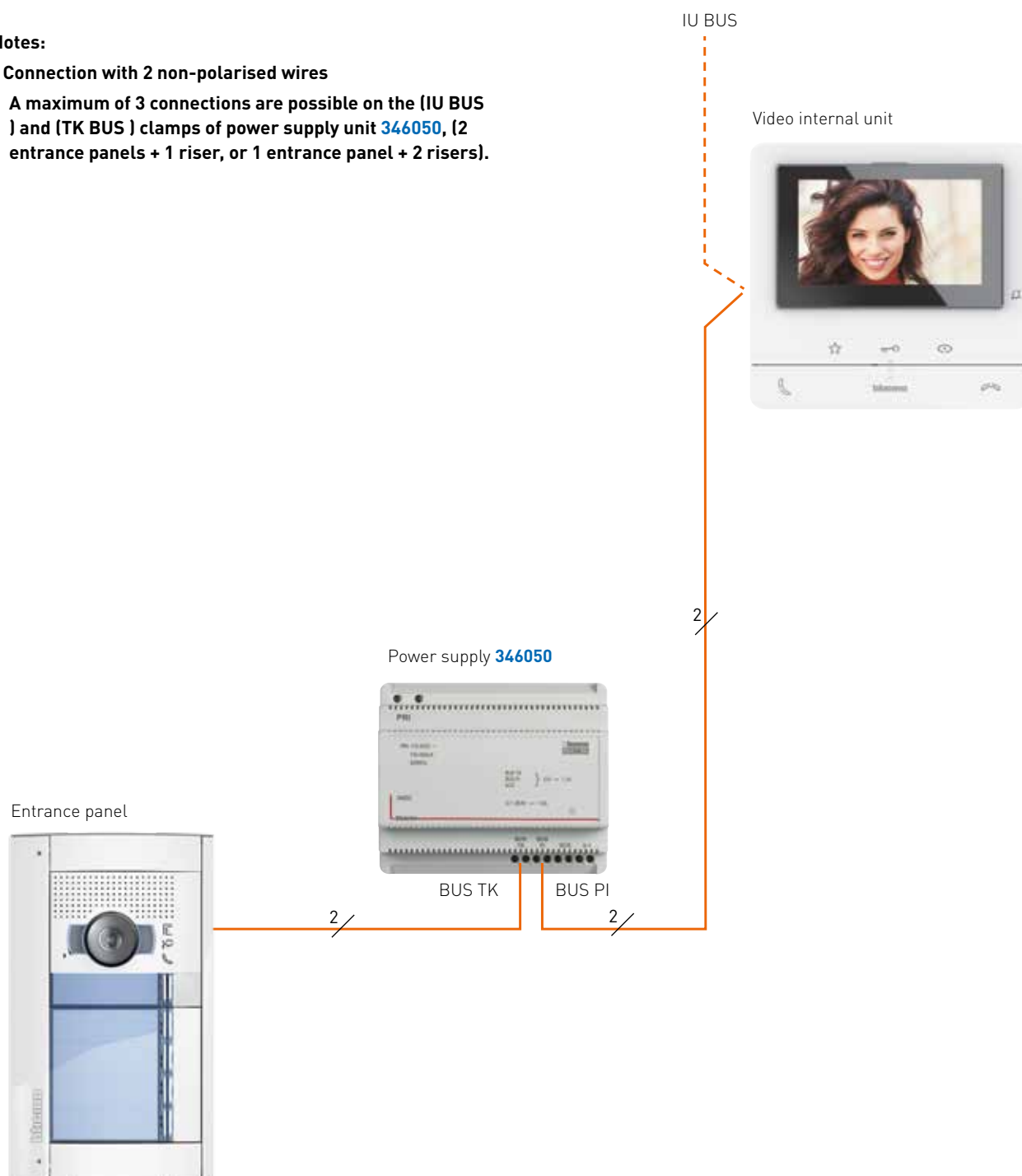

## Video systems

### EXAMPLE OF A SYSTEM WITH AUDIO VIDEO NODE F441

The F441 audio/video node must be used in conjunction with power supply unit 346050, when the system includes more than 2 entrance panels or when more than 2 risers are required.

In case of tabletop installation or internal units with simultaneous switching on, assign a dedicated audio/video output to each video internal unit.

#### Notes:

- Connection with 2 non polarised wires.
- Up to 26 internal units and 6 floor shunts, item 346841, may be connected to each riser connected to the output of the F441 audio/video node.

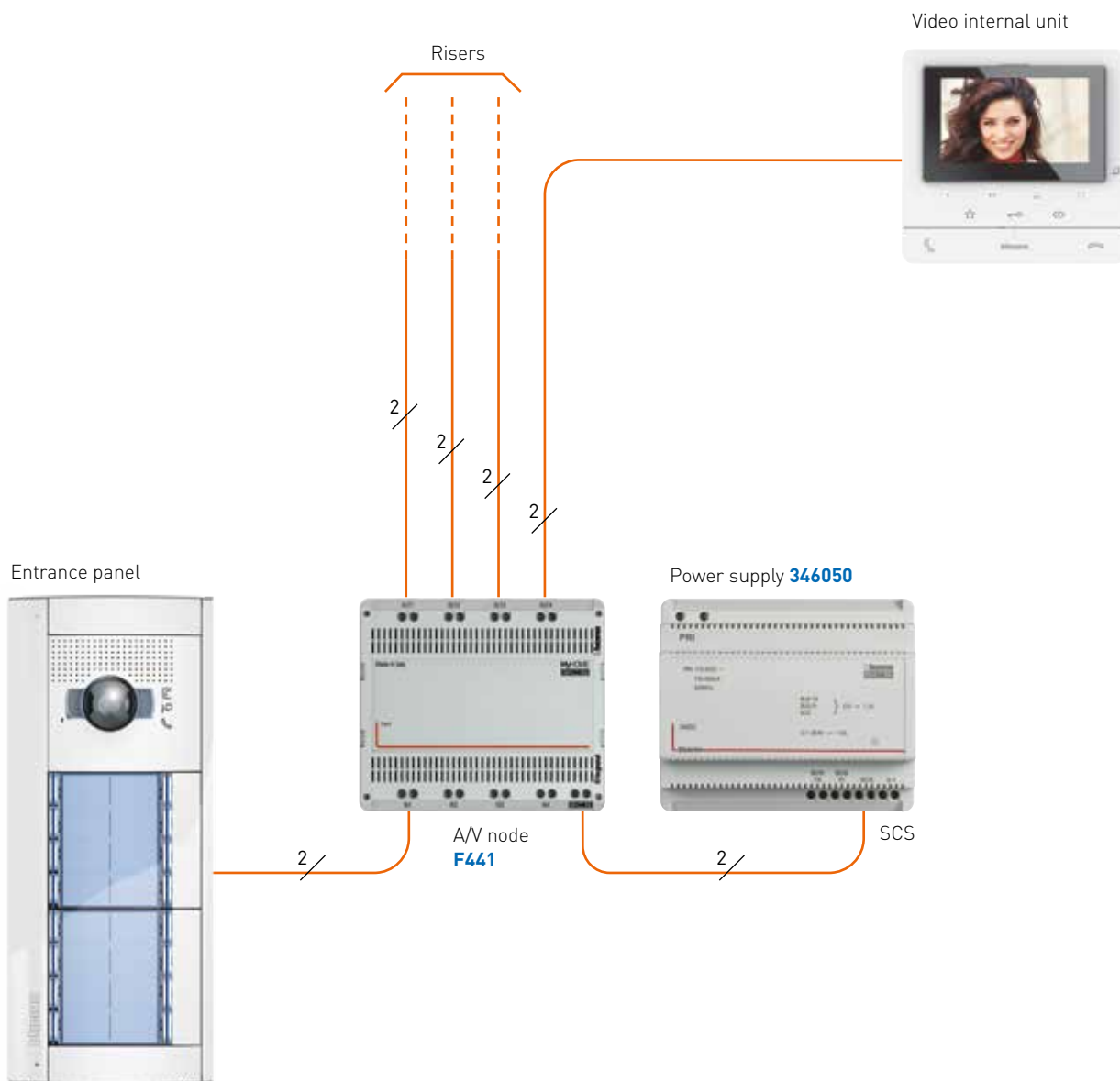

For correct sizing of the system, we recommend the use of the [YouDiagram](https://www.youdiagram.com) software - which can be downloaded free of charge from [www.bticino.com](http://www.bticino.com).

### EXAMPLE OF APARTMENT BLOCK SYSTEM WITH 2 RISERS

For the installation of multifamily video systems, it is possible to use the floor shunt item [346841](#).

It allows significant savings on the cable being used.

It is particularly suited to multifamily systems with several dwellings on the same floor, and to multifamily systems with high distance between entrance panel and internal units.

Using the star connection method, the floor shunt makes it possible to connect up to 3 apartment internal units (max 1 internal unit for each output with simultaneous switching on).

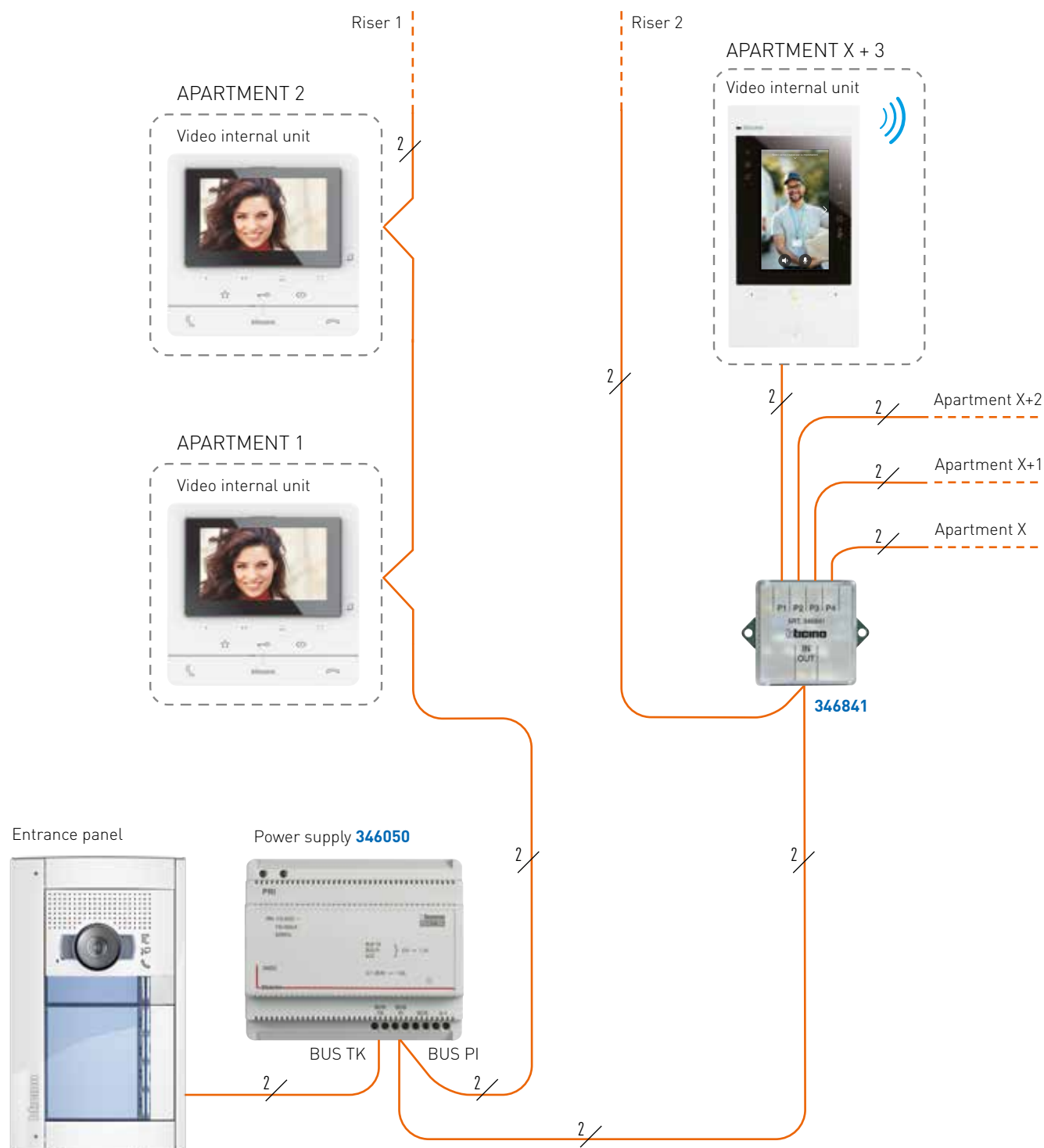

## Video systems

### VIDEO SYSTEM WITH POWER SUPPLY 346050

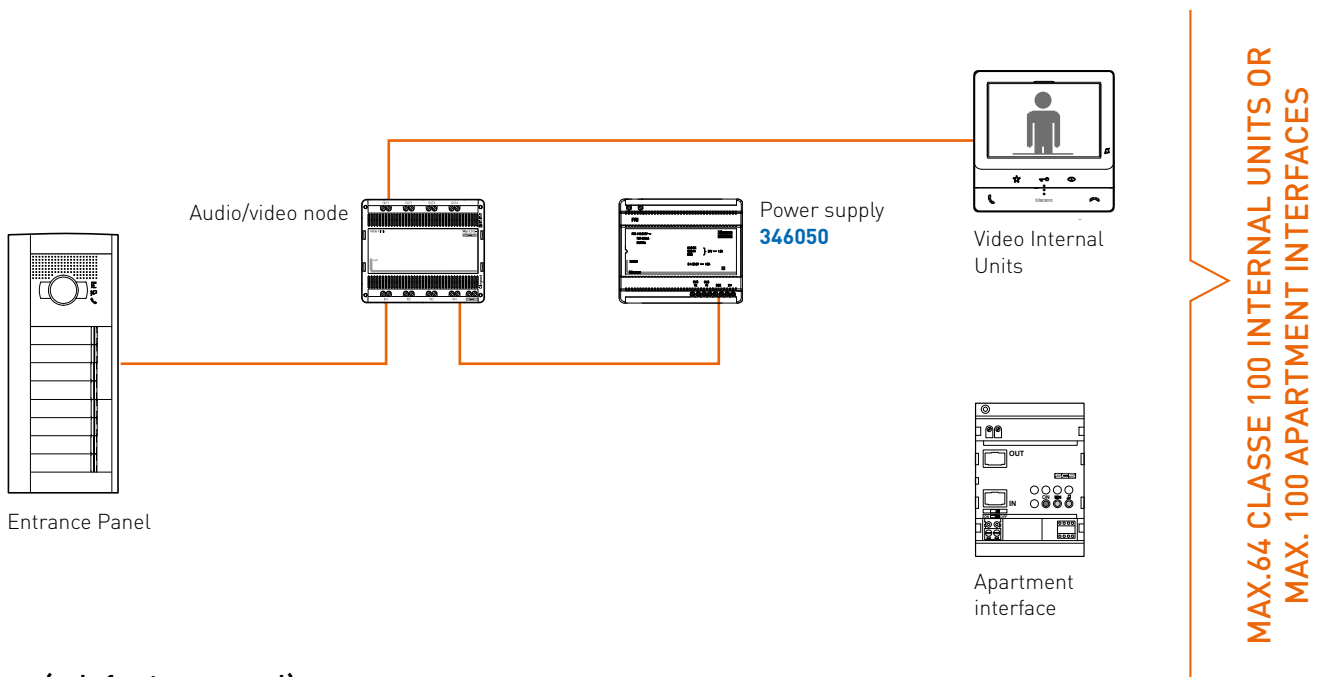

- **(only 1 entrance panel)**
- **For different installation combinations refer to the general installation rules.**

#### GENERAL CONSIDERATIONS:

For the sizing of the system when using interfaces 346850 and 346851 galvanically insulated systems must be separated. Interface 346850 is a galvanically insulated device. It therefore requires double power supply (1 device downstream and 1 device upstream the device).

For each galvanically insulated system, the indication of the tables of the following pages apply, considering, as first approximation, interfaces 346850 and 346851 in the same way as an EP (for the part connected to the TK / IN BUS F441 audio/video node) and as an IU (for the part connected to the IU / OUT BUS F441 audio/video node).

However, we always recommend the use of the YouDiagram software to ascertain the feasibility of the system and calculate absorptions.

The number of internal units varies depending on the number of entrance panels and actuators of the system. When calculating the number of internal units that can be connected, also consider any devices (audio/video internal units, bells/ringtones) connected in parallel.

#### EXAMPLES OF VIDEO SYSTEMS:

In a video system with 1 entrance panel, it will be possible to connect up to 64 entrance panels (Classe 100). For example it is possible to connect:

- 64 Apartments with 1 IU (or 100 apartments with apartment interface 346850).
- 50 Apartments with 1 IU (or apartment interface 346850); 7 Apartments with 2 IU ( $50 + (7 \times 2) = 64$ )
- 38 Apartments with 1 IU (or apartment interface 346850), 10 apartments with 2 IU, 1 apartment with 3 IU and 1 actuator for generic loads ( $38 + (10 \times 2) + (1 \times 3) + 3 = 64$ ).

## SYSTEM WITH AUDIO VIDEO NODE F441

In systems with more than 2 video entrance panels, audio/video node **F441** must be used.

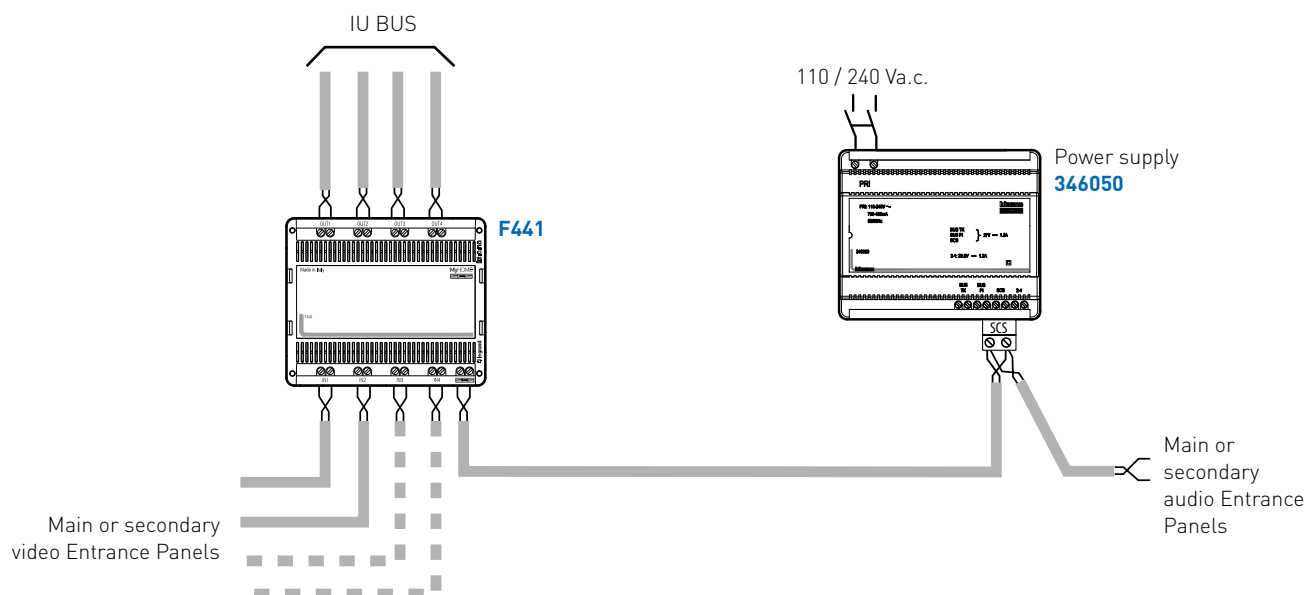

Using the **F441** audio/video node, it is possible to connect up to 4 video entrance panels and 4 risers. Audio entrance panels can be connected to both the SCS clamp or the IN clamp of the audio/video node. The absorption of the devices connected to the outputs of the audio/video node MUST be  $\leq 720$  mA.

In systems requiring a high number of internal units, it will be possible to use an additional power supply for local powering of video Sfera entrance panels. Or it will be possible to expand the riser with system expansion interface **346851** and corresponding power supply unit.

In alternative to the video entrance panels (without local power supply), it is also possible to use native 2 WIRES cameras and /or interfaces (**347400**) for the connection of cameras with COAX output.

The tables of the following pages show the video systems completed with the different types of internal units, classed as follows:

- Classe 100 internal units;
- Classe 300EOS / Classe 100X connected internal units.

In multi-family systems, Classe 300EOS internal units MUST ALWAYS be used with local power supply (power supply **346020**).

# Video systems

## POWER SUPPLY 346050 CONNECTION RULES

6 DIN power supply for audio, video or audio video mixed 2 WIRES systems. The output provides two power supplies in low safety voltage (one on the 3 BUS TK, BUS PI and SCS clamps, one on the 1 - 2 clamp) to be used alternately and NOT at the same time.

The (BUS TK), (BUS PI) and (SCS) outputs can be used at the same time respecting the total maximum absorption of 1.2 A.

Up to a maximum of 3 connections/shunts are possible on the (BUS TK) and (BUS PI) clamps (2 IU risers + 1 TK maximum or 1 IU riser and 2 TK maximum).

The device can also be used as additional power supply (1 - 2 output) for the local power supply of the preset internal units or entrance panels - in this case, it is NOT possible to use other outputs.

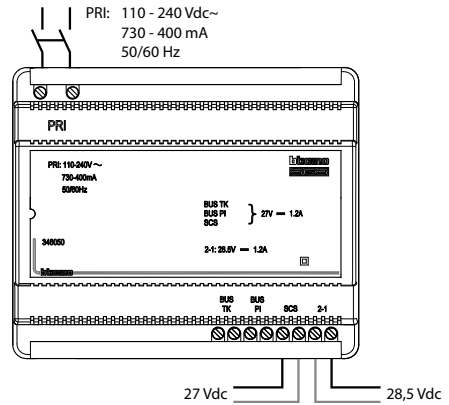

### EXAMPLE OF 1 EP + 1 IU RISER CONNECTION

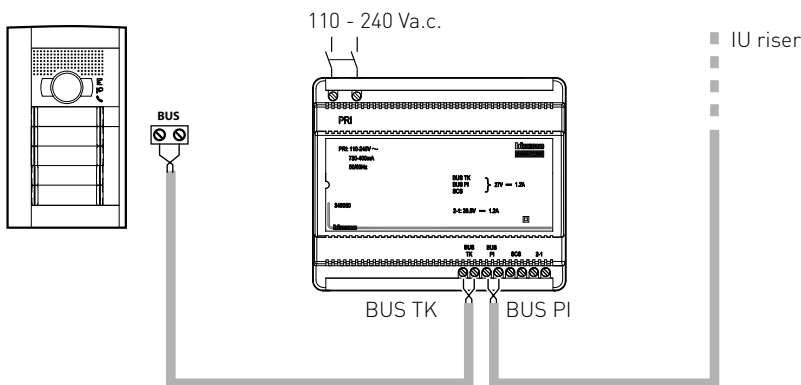

### EXAMPLE OF THE CONNECTION 1 EP + 2 IU RISERS

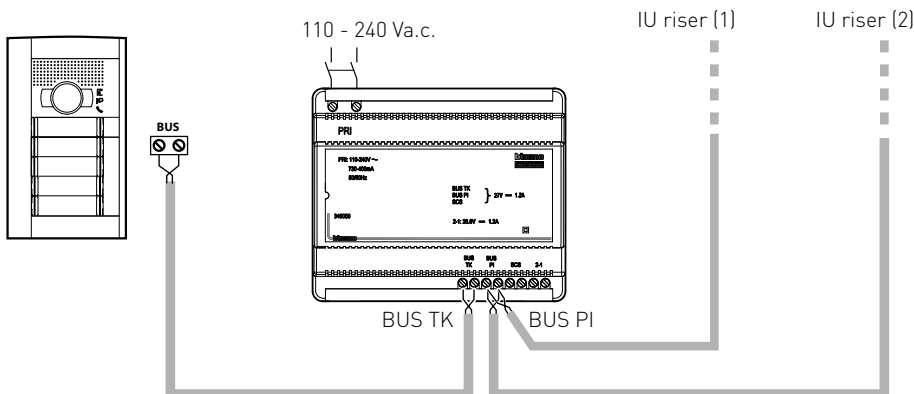

## POWER SUPPLY 346050 CONNECTION

### EXAMPLE OF 2 EP + 1 IU RISER CONNECTION

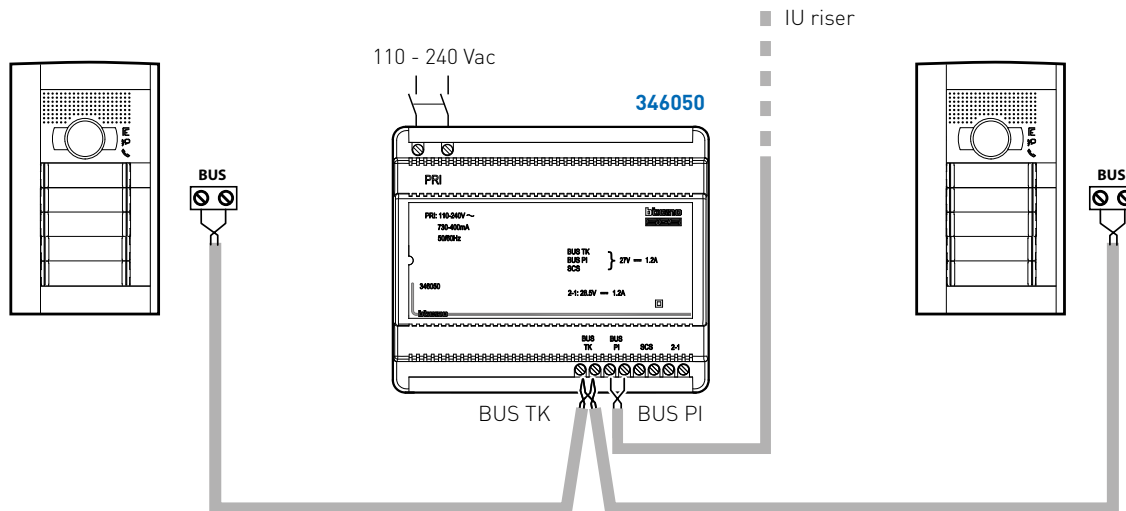

### EXAMPLE OF AUDIO VIDEO NODE F441 CONNECTION

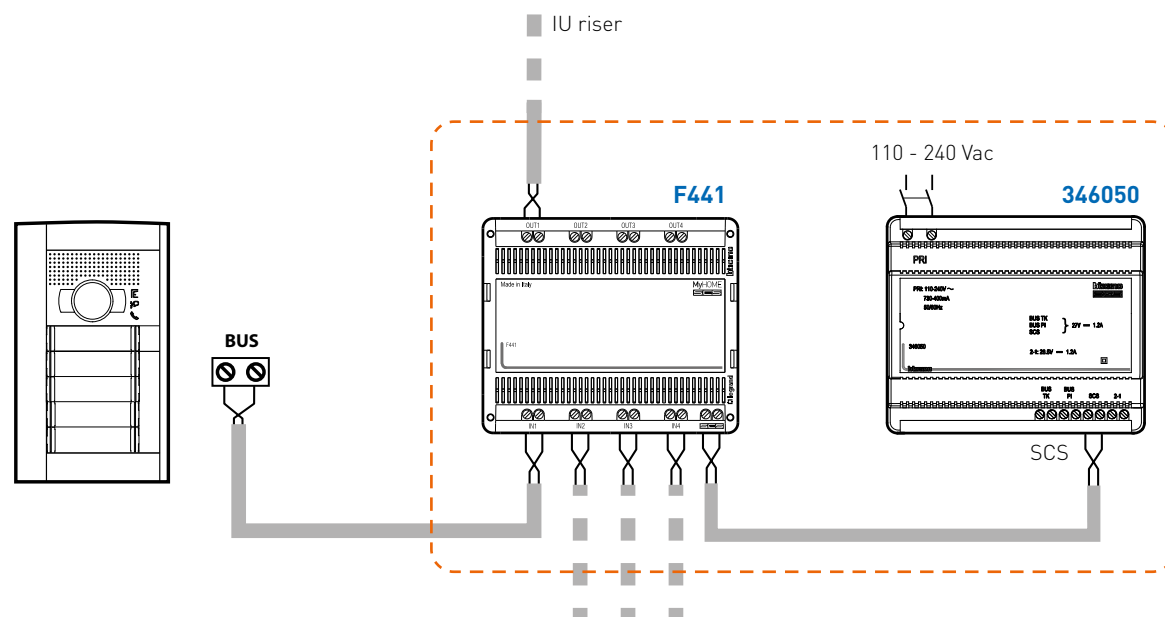

## Video systems

### POSSIBLE COMBINATIONS (WIRING WITH FLOOR SHUNT)

#### MULTIFAMILY COLOUR BASIC VIDEO SYSTEMS

#### MAX NUMBER OF INTERNAL UNITS FOR SYSTEMS WITH SFERA NEW / ROBUR PUSHBUTTON PANELS

No. of video colour entrance panels	System power supply	Additional power supply for entrance panels	SFERA PUSHBUTTON PANELS INCLUDE: SPEAKER MODULE + CAMERA + PUSHBUTTONS	SFERA PUSHBUTTON PANELS INCLUDE: DISPLAY (352500)	SFERA PUSHBUTTON PANELS INCLUDE: SPEAKER MODULE (351100) + CAMERA (352400) + DISPLAY (352500) + KEYPAD (353000)	SFERA PUSHBUTTON PANELS INCLUDE: SPEAKER MODULE (351100) + CAMERA (352400) + KEY EXPANSION (346993)
			or SPEAKER MODULE + AUDIO/VIDEO + PUSHBUTTONS		OR AUDIO/VIDEO (351200/351300) + DISPLAY (352500) + KEYPAD (353000)	
			Max No. of internal units-system only with CLASSE 100 IU	Max No. of internal units-system only with CLASSE 100 IU	Max No. of internal units-system only with CLASSE 100 IU	Max No. of internal units-system only with CLASSE 100 IU
1 video	1	-	44	42	40	48
2 video	1	-	40	36	32	44
3 video	1	-	36	32	26	40
4 video	1	-	32	26	-	36
1 main video + 2 secondary audio or video	1	-	18	40	36	44
1 video	1	1	64	64	64	64
2 video	1	2	64	64	64	64
3 video	1	3	64	64	64	64
4 video	1	4	64	64	64	64
1 main video* 2 secondary audio	1	1(*)	56	56	56	60

(\*) Additional power supply on main video EP.

**CAUTION: the installation of Classe 300E0S internal units in multi family systems requires additional power supply for the video internal units. Refer to the specific technical sheet.**

#### NOTES:

- All the combinations are calculated with entrance panels (both main and secondary) with modules with 8 call keys.
- The main entrance panels are those that can call all the internal units, while secondary entrance panels can only call some internal units.
- Systems with "main and secondary" entrance panels HAVE NO independent audio (this means that only 1 communication session at the time is guaranteed).
- The number of call keys for each secondary EP is calculated by dividing the total number of IU that can be installed by the total number of secondary EP (secondary EP consisting of modules with 8 keys, like the main EP).
- In sizing the systems, it will be necessary to also take into account the introduction of other components: these will take away further IU from the system:
  - for each **additional plate module** (in addition to the already indicated ones), it will be necessary to **remove 1 IU**;
  - for each generic load **actuator 346210** or **call repeater**, it will be necessary to **remove 1 IU**;
  - for each **door lock actuator 346230**, it will be necessary to **remove 3 IU**;
  - for each **floor call interface 346833**, it will be necessary to **remove 1 IU**;
  - for each **special control**, it will be necessary to **remove 1 IU**.



In view of the many installation possibilities, the values shown on the table are only indicative. For correct sizing of the system, we recommend the use of the **YouDiagram** software - which can be downloaded free of charge from [www.bticino.com](http://www.bticino.com).



## POSSIBLE COMBINATIONS (IN-OUT WIRING)

### MULTIFAMILY COLOUR BASIC VIDEO SYSTEMS

#### MAX NUMBER OF INTERNAL UNITS FOR SYSTEMS WITH SFERA NEW / ROBUR PUSHBUTTON PANELS

			SFERA PUSHBUTTON PANELS INCLUDE: SPEAKER MODULE + CAMERA + PUSHBUTTONS or SPEAKER MODULE + AUDIO/ VIDEO + PUSHBUTTONS	SFERA PUSHBUTTON PANELS INCLUDE: DISPLAY (352500)	SFERA PUSHBUTTON PANELS INCLUDE: SPEAKER MODULE (351100) + CAMERA (352400) + DISPLAY (352500) + KEYPAD (353000) OR AUDIO/VIDEO (351200/351300) + DISPLAY (352500) + KEYPAD (353000)	SFERA PUSHBUTTON PANELS INCLUDE: SPEAKER MODULE (351100) + CAMERA (352400) + KEY EXPANSION (346993)
No. of video colour entrance panels	System power supply	Additional power supply for entrance panels	Max No. of internal units-system only with CLASSE 100 IU	Max No. of internal units-system only with CLASSE 100 IU	Max No. of internal units-system only with CLASSE 100 IU	Max No. of internal units-system only with CLASSE 100 IU
1 video	1	-	60	60	56	64
2 video	1	-	52	52	46	56
3 video	1	-	44	44	36	48
4 video	1	-	40	36	-	40
1 main video + 2 secondary audio or video	1	-	52	52	48	56
1 video	1	1	64	64	64	64
2 video	1	2	64	64	64	64
3 video	1	3	64	64	64	64
4 video	1	4	64	64	64	64
1 main video* 2 secondary audio	1	1(*)	64	64	64	64

(\*) Additional power supply on main video EP.

**CAUTION: the installation of Classe 300E0S internal units in multi family systems requires additional power supply for the video internal units. Refer to the specific technical sheet.**

#### NOTES:

- All the combinations are calculated with entrance panels (both main and secondary) with modules with 8 call keys.
- The main entrance panels are those that can call all the internal units, while secondary entrance panels can only call some internal units.
- Systems with "main and secondary" entrance panels HAVE NO independent audio (this means that only 1 communication session at the time is guaranteed).
- The number of call keys for each secondary EP is calculated by dividing the total number of IU that can be installed by the total number of secondary EP (secondary EP consisting of modules with 8 keys, like the main EP).
- In sizing the systems, it will be necessary to also take into account the introduction of other components: these will take away further IU from the system:
  - for each **additional plate module** (in addition to the already indicated ones), it will be necessary to **remove 1 IU**;
  - for each generic load **actuator 346210** or **call repeater**, it will be necessary to **remove 1 IU**;
  - for each **door lock actuator 346230**, it will be necessary to **remove 3 IU**;
  - for each **floor call interface 346833**, it will be necessary to **remove 1 IU**;
  - for each **special control**, it will be necessary to **remove 1 IU**.



In view of the many installation possibilities, the values shown on the table are only indicative. For correct sizing of the system, we recommend the use of the [YouDiagram](#) software - which can be downloaded free of charge from [www.bticino.com](http://www.bticino.com).

## Video systems

### SINGLE FAMILY OR MULTIFAMILY COLOUR VIDEO SYSTEMS WITH APARTMENT INTERFACE 346850: MAX. NUMBER OF INTERNAL UNITS

		SFERA	SFERA A/V	LINEA 2000	LINEA 3000
No. of private video entrance panels	System power supply	Max. No. of internal units-system with Classe 100 and CLASSE 300EOS	Max. No. of internal units-system with Classe 100 and CLASSE 300EOS	Max. No. of internal units-system with Classe 100 and CLASSE 300EOS	Max. No. of internal units-system with Classe 100 and CLASSE 300EOS
1 video	1	5			
2 video	1				
3 video	1				
4 video (*)	1				

(\*) Only for single family systems (without apartment interface).

General rules for single family systems:

- By configuring the EP with (S = 9), general call / call forward is set to all the IU at the same time.
- When more than 1 IU is installed in the home, the configuration of the IU must start from (N=1), while the EP must be configured (in addition to S = 9), with (N = 1).
- To switch the IU on at the same time, each secondary IU must be powered locally.

#### NOTES:

- Only 1 CLASSE 300EOS / Classe 100X connected internal unit can be installed in the system;
- Only 1 internal unit with video answering machine can be installed in the system.
- If the entrance panel is configured for general call (S = 9), the internal unit with video answering machine must be the one configured with (N = 1).
- The system requires the activation of the call repetition through the APP on one video internal unit

# System performance - single family video systems

## MAXIMUM DISTANCES AND CABLE FEATURES

### CAUTION!

The use of conductors with characteristics other than the prescribed ones does NOT guarantee correct performance of the system and good quality of the video signal.

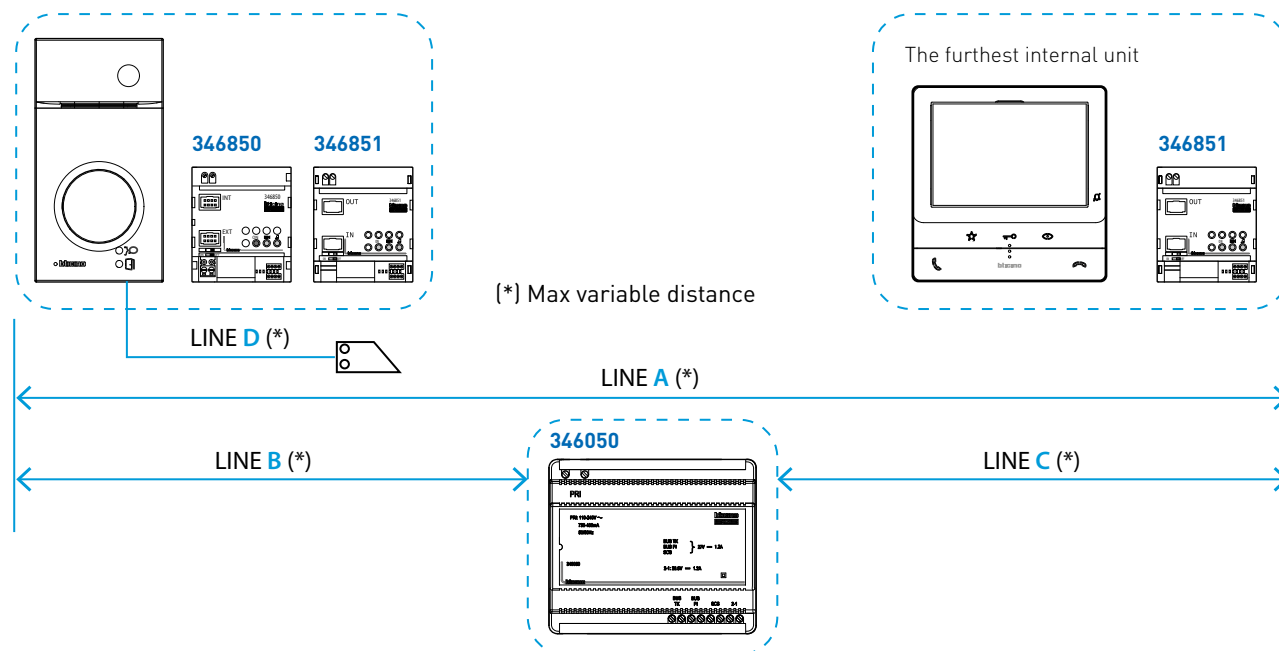

### BTICINO CABLES

	BTicino L4669  0.35 mm <sup>2</sup>	BTicino C9881U/5E  AWG24 UTP5	BTicino 336904  336905
LINE A	50 m	145 m	200 m
LINE B	50 m	80 m	200 m
LINE C	25 m	65 m	200 m
LINE D	50 m	-	50 m

### OTHER CABLES

	 >0.2 mm	 0.28 mm <sup>2</sup>	One PTT 278 TP 0.28 mm <sup>2</sup>	OneSYT +Digital TP 5/10	OneSYT +Num TP 5/10	GIGA TW CAT5E AWG24	OneSYT +Num TP 8/10	Cable ARB.6060-1 6/10	Cable EV6R 6/10	1 mm <sup>2</sup>
LINE A	50 m	140 m	200 m	150 m		200 m	50 m	-		
LINE B	50 m	115 m	115 m	80 m		200 m	50 m	-		
LINE C	25 m	50 m	100 m	65 m		200 m	50 m	-		
LINE D	50 m	30 m	30 m	-		-	-	100 m		

In systems where the EP is replaced by apartment interface 346850, and where the distance (B) is less than 1 m, the (C line) can reach the maximum distance of 200 m when using the cable 336904.

# System performance - multi family video systems

**MULTI-FAMILY VIDEO SYSTEMS MADE ONLY WITH CLASSE 100 AND CLASSE 300EOS WITH NETATMO INTERNAL UNITS.**

**CAUTION!**

The use of conductors with characteristics other than the prescribed ones does NOT guarantee correct performance of the system and good quality of the video signal.

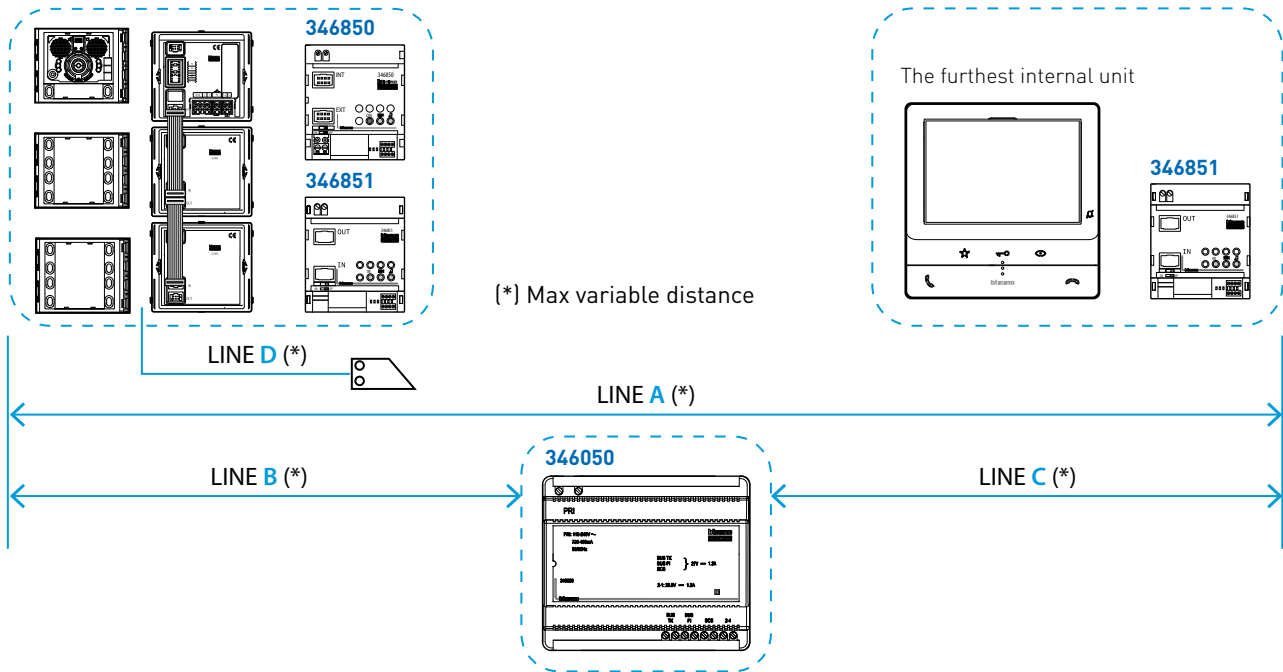

**MAXIMUM DISTANCE ( LINE A ), ENTRANCE PANEL - FURTHEST INTERNAL UNIT**

**MAXIMUM DISTANCE (LINE B) ENTRANCE PANEL - POWER SUPPLY**

	2 normal cables >0.2 mm <sup>2</sup>	Bticino cable 336904/336905 0.5 mm <sup>2</sup>	Telephone twisted pair 0.28 mm <sup>2</sup>	A pair of the multi-pair data cable CAT5
2 IU/2 pushbuttons	50 m	200 m	140 m	180 m
5 IU/5 pushbuttons	50 m	200 m	140 m	155 m
10 IU/10 pushbuttons	50 m	200 m	140 m	145 m
26 IU/26 pushbuttons	50 m	200 m	140 m	125 m
38 IU/38 pushbuttons	50 m	200 m	140 m	110 m
38 IU/ display call	50 m	200 m	140 m	115 m
64 IU/ display call	50 m	200 m	140 m	-

	2 normal cables >0.2 mm <sup>2</sup> or L4669	Bticino cable 336904/336905 0.5 mm <sup>2</sup>	Telephone twisted pair 0.28 mm <sup>2</sup>	A pair of the multi-pair data cable CAT5
2 pushbuttons	50 m	200 m	130 m	95 m
5 pushbuttons	50 m	190 m	120 m	85 m
10 pushbuttons	50 m	180 m	110 m	80 m
26 pushbuttons	50 m	150 m	100 m	70 m
38 pushbuttons	50 m	140 m	90 m	65 m
Display call	50 m	150 m	95 m	65 m

**MAXIMUM DISTANCE (LINE C), POWER SUPPLY - FURTHEST INTERNAL UNIT**

**MAXIMUM DISTANCE (LINE D) ENTRANCE PANEL - DOOR LOCK**

	2 normal cables >0.2 mm <sup>2</sup>	Bticino cable 336904/336905 0.5 mm <sup>2</sup>	Telephone twisted pair 0.28 mm <sup>2</sup>	A pair of the multi-pair data cable CAT5
2 IN/OUT IU	50 m	200 m	140 m	95 m
5 IN/OUT IU	50 m	200 m	135 m	90 m
10 IN/OUT IU	50 m	190 m	130 m	85 m
26 IN/OUT IU	50 m	170 m	120 m	75 m
5 IU ( SHUNTED)	50 m	200 m	110 m	80 m
10 IU ( SHUNTED)	50 m	175 m	100 m	70 m
26 IU ( SHUNTED)	50 m	145 m	80 m	60 m
38 IU ( SHUNTED)	50 m	125 m	70 m	50 m
64 IU ( SHUNTED)	-	95 m	55 m	-

	0.28 mm <sup>2</sup>	Bticino cable L4669 0.35 mm <sup>2</sup>	Bticino cable 336904/336905 0.5 mm <sup>2</sup>	1 mm <sup>2</sup>
(S+/S-) clamps	30 m	30 m	50 m	100 m

- Risers with max 26 internal units should be made in systems with more than 26 internal units.
- Classe 300EOS with Netatmo must be always installed with additional power supply (2- 1).
- For correct sizing of the system, we recommend the use of the YouDiagram software which can be downloaded free of charge from [www.professionisti.bticino.it](http://www.professionisti.bticino.it)

## MAXIMUM DISTANCES AND CABLE FEATURES - SYSTEMS MADE WITH AT LEAST 1 CLASSE 300EOS IU

### CAUTION!

The use of conductors with characteristics other than the prescribed ones does NOT guarantee correct performance of the system and good quality of the video signal.

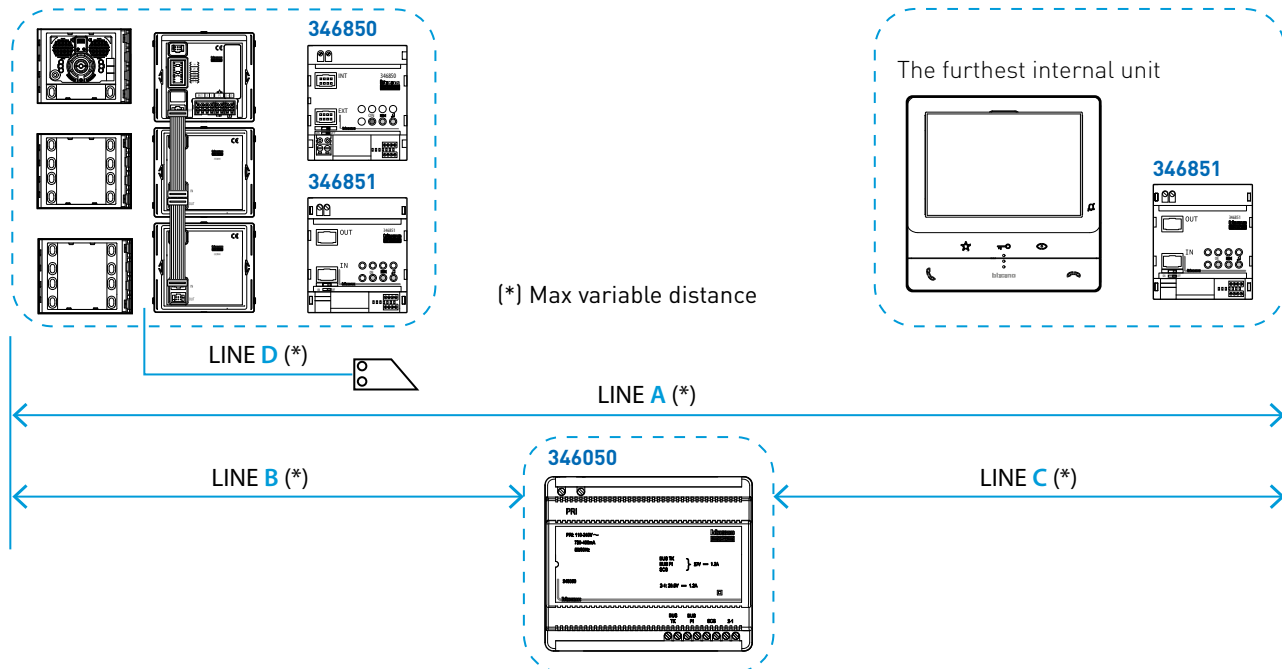

MAXIMUM DISTANCE ( LINE A ), ENTRANCE PANEL - FURTHEST INTERNAL UNIT

	2 normal cables >0.2 mm <sup>2</sup>	BTicino cable 336904/336905 0.5 mm <sup>2</sup>	Telephone twisted pair 0.28 mm <sup>2</sup>	A pair of the multi-pair data cable CAT5
2 IU/2 pushbuttons	50 m	200 m	140 m	180 m
5 IU/5 pushbuttons	50 m	200 m	140 m	155 m
10 IU/10 pushbuttons	50 m	200 m	140 m	145 m
18 IU/18 pushbuttons	50 m	200 m	140 m	125 m
16 IU display call	50 m	200 m	140 m	110 m

MAXIMUM DISTANCE (LINE B) ENTRANCE PANEL - POWER SUPPLY

	2 normal cables >0.2 mm <sup>2</sup> or L4669	BTicino cable 336904/336905 0.5 mm <sup>2</sup>	Telephone twisted pair 0.28 mm <sup>2</sup>	A pair of the multi-pair data cable CAT5
2 pushbuttons	50 m	200 m	130 m	95 m
5 pushbuttons	50 m	190 m	120 m	85 m
10 pushbuttons	50 m	180 m	110 m	80 m
18 pushbuttons	50 m	170 m	105 m	75 m
Display call	50 m	150 m	95 m	65 m

MAXIMUM DISTANCE (LINE C), POWER SUPPLY - FURTHEST INTERNAL UNIT

	2 normal cables >0.2 mm <sup>2</sup>	BTicino cable 336904/336905 0.5 mm <sup>2</sup>	Telephone twisted pair 0.28 mm <sup>2</sup>	A pair of the multi-pair data cable CAT5
2 IN/OUT IU	50 m	200 m	140 m	95 m
5 IN/OUT IU	50 m	180 m	115 m	75 m
10 IN/OUT IU	50 m	140 m	90 m	60 m
18 IN/OUT IU	50 m	90 m	50 m	35 m
5 IU ( SHUNTED)	50 m	160 m	95 m	70 m
10 IU ( SHUNTED)	50 m	120 m	80 m	55 m
16 IU ( SHUNTED)	50 m	80 m	45 m	30 m

MAXIMUM DISTANCE (LINE D) ENTRANCE PANEL - DOOR LOCK

	0.28 mm <sup>2</sup>	BTicino cable L4669 0.35 mm <sup>2</sup>	BTicino cable 336904/336905 0.5 mm <sup>2</sup>	1 mm <sup>2</sup>
(S+/S-) clamps	30 m	30 m	50 m	100 m

- If all the Classe 300EOS internal units in the system are supplied locally the system should be considered as being made with Classe 100 internal units only (see previous page).
- Risers with max 26 internal units should be made in systems with more than 26 internal units.

# System performance - multi family video systems

## VIDEO SYSTEMS WITH AMPLIFIER 346870 (ONLY WITH NOT TWISTED CABLES)

The use of line amplifier 346870 makes it possible to install systems with non-twisted cables longer than 50 metres (up to a maximum of 100 metres). Its use is ideal in restorations and in the repair of existing systems.

- The signal amplifier must be connected using non-twisted cables with section  $\geq 0,28 \text{ mm}^2$ , non polarised.
- The signal amplifier must be connected at the 50th metre distance from the entrance panel. Connections at shorter distances can cause a distortion of the video signal, while at longer distances they would be pointless. In case of use of audio/video node F441, to avoid signal distortions on the inputs of the node that do not require amplification (< 50 m), we recommend to connect item 346870 only to the B line of the inputs to amplify.
- Up to 18 internal units may be installed downstream the amplifier.

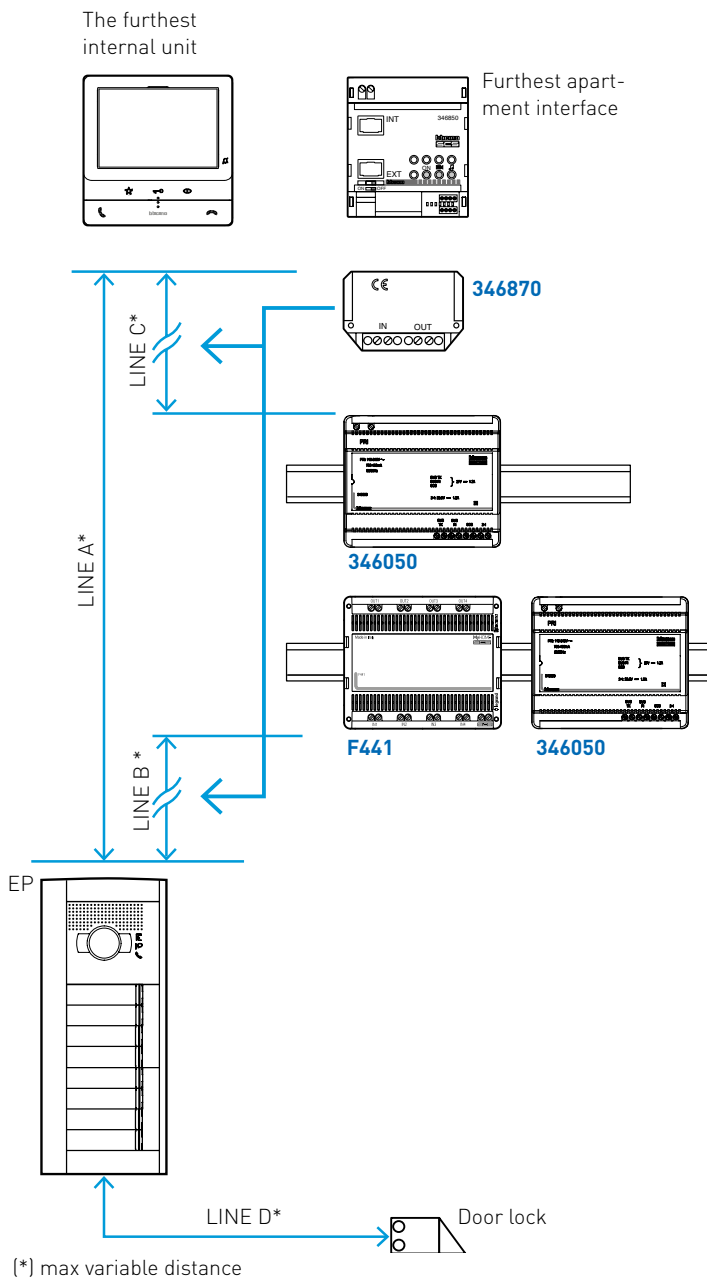

### MAX. DISTANCE LINE A ENTRANCE PANEL - FURTHEST INTERNAL UNIT

Without 346870	With 346870
50 m	100 m

### MAX. DISTANCE LINE C THE FURTHEST INTERNAL UNIT- POWER SUPPLY

Without 346870	With 346870
50 m	100 m

### MAX. DISTANCE LINE D ENTRANCE PANEL - DOOR LOCK

	0.28 mm <sup>2</sup>	BTicino SCS cable L4669 0.35 mm <sup>2</sup>	BTicino SCS cable 336904/336905 0.5 mm <sup>2</sup>	1 mm <sup>2</sup>
S+ S- clamps	30 m	30 m	50 m	100 m

# System expansion with interfaces

Audio and video 2 WIRES systems can be expanded thanks to three different types of interfaces:

## APARTMENT INTERFACE [346850](#)

It gives the possibility of installing a dedicated 2 WIRES system independent from the apartment block riser.

The system downstream the interface (internal to the apartment/dwelling) can have dedicated entrance panels and cameras.

It is possible to make intercom calls inside and outside the apartment using preset internal units.



346850

## SYSTEM EXPANSION INTERFACE [346851](#)

It gives the possibility of creating up to 39 isolated risers with independent audio and video. It can also be used to expand the maximum physical limits of the system (maximum distance 600 m with BTicino cable [336904](#)), or to increase the number of devices that can be connected to the BUS.

It is possible to connect up to a maximum of 3 interfaces in cascade.



346851

## 2 WIRES / IP INTERFACE [346891](#)

It gives the possibility of installing very extended mixed 2 WIRES / IP systems with a large number of devices (entrance panels, internal units and interfaces).

The system will have an IP backbone and 2 WIRES risers.

The IP backbone must be dedicated to the door entry system. Thanks to the IP guard station (software), it makes it possible to manage advanced functions.

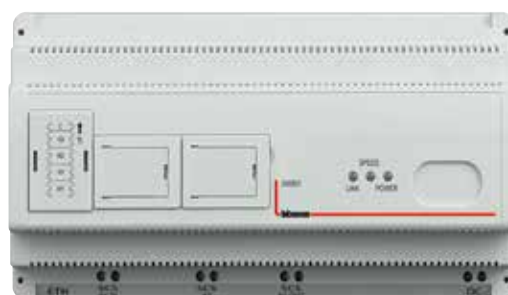

346891

**CAUTION: the interface is NOT compatible with Classe 300EOS and HOMETOUCH internal units.**

**ONLY use in systems with Classe 100 internal units.**

## System expansion with interfaces

### EXAMPLE OF USE OF THE INTERFACE 346850

Example of connection for the installation of an apartment system independent from the apartment block system. In this way, the apartment system can have private cameras and entrance panels, and can be integrated with home automation applications..

The use of apartment interface 346850 makes it possible to have independent audio intercom inside the apartment. This gives the possibility making intercom calls inside the apartment that will not be interrupted if the main EP calls another apartment.

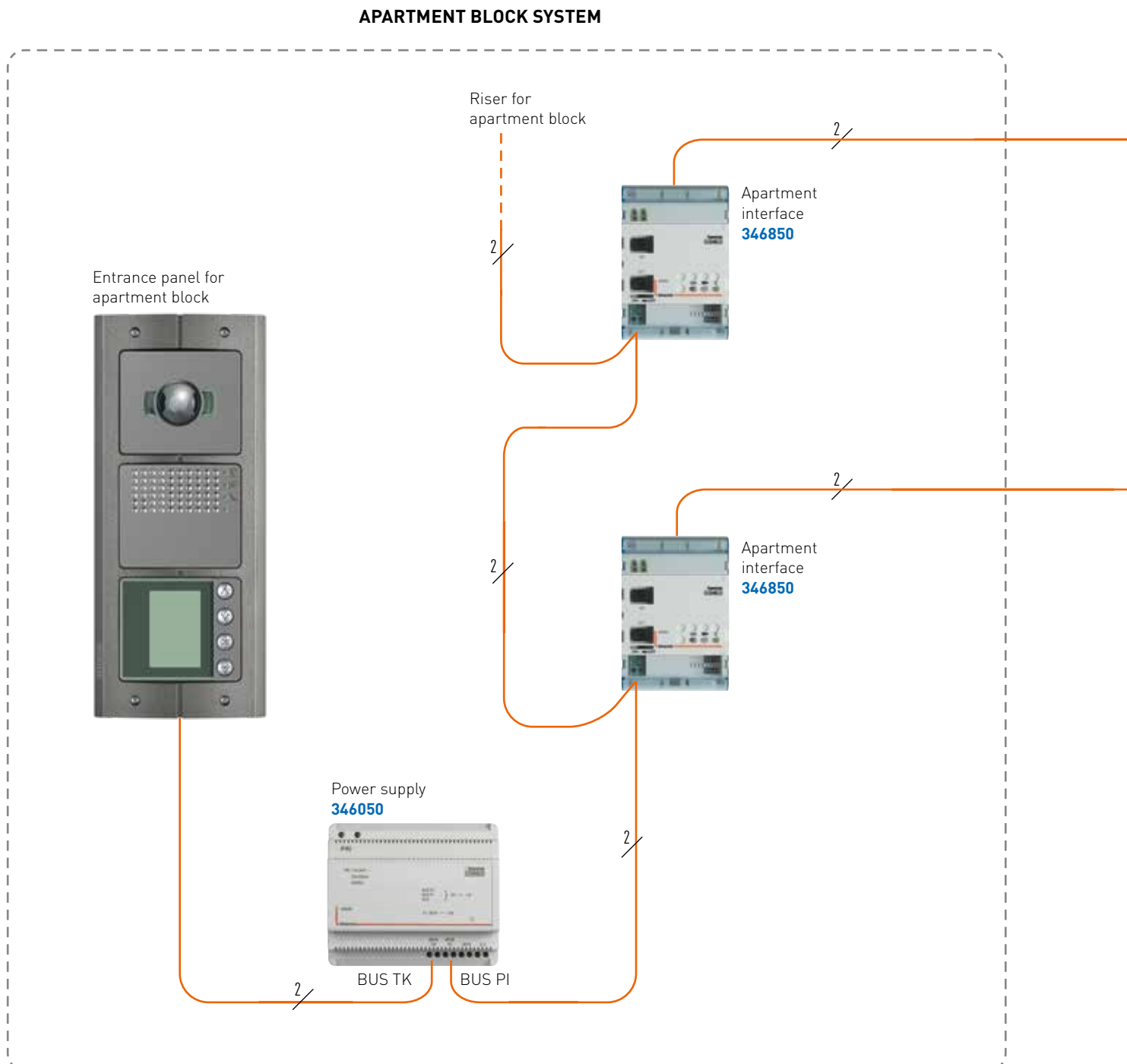



**SYSTEM OF APARTMENT 2**

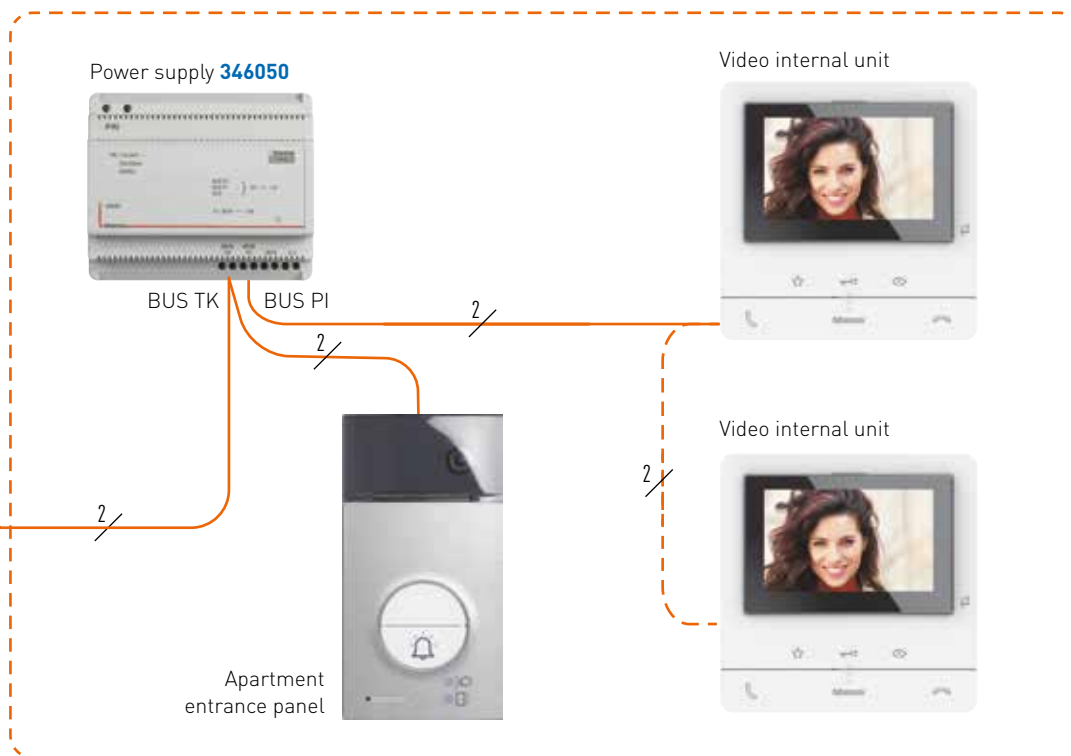

**SYSTEM OF APARTMENT 1**

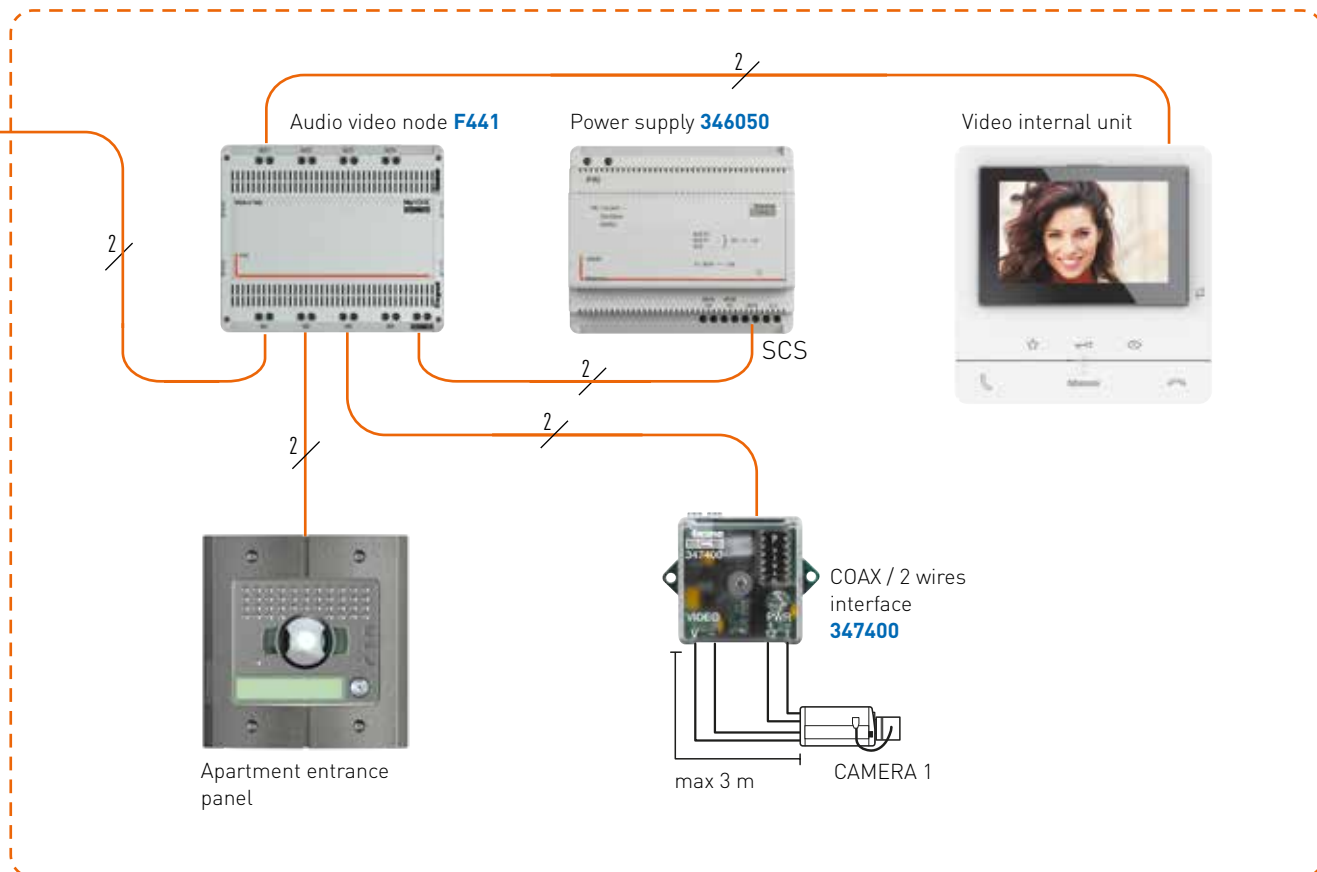

# System expansion with interfaces

## EXAMPLE OF 346851 INTERFACE CONNECTION (MOD=5)

It must be used in apartment blocks, to install 2 WIRES risers with riser entrance panels. With this solution, audio and video are independent from the other risers.

### COMMON SYSTEM SECTION

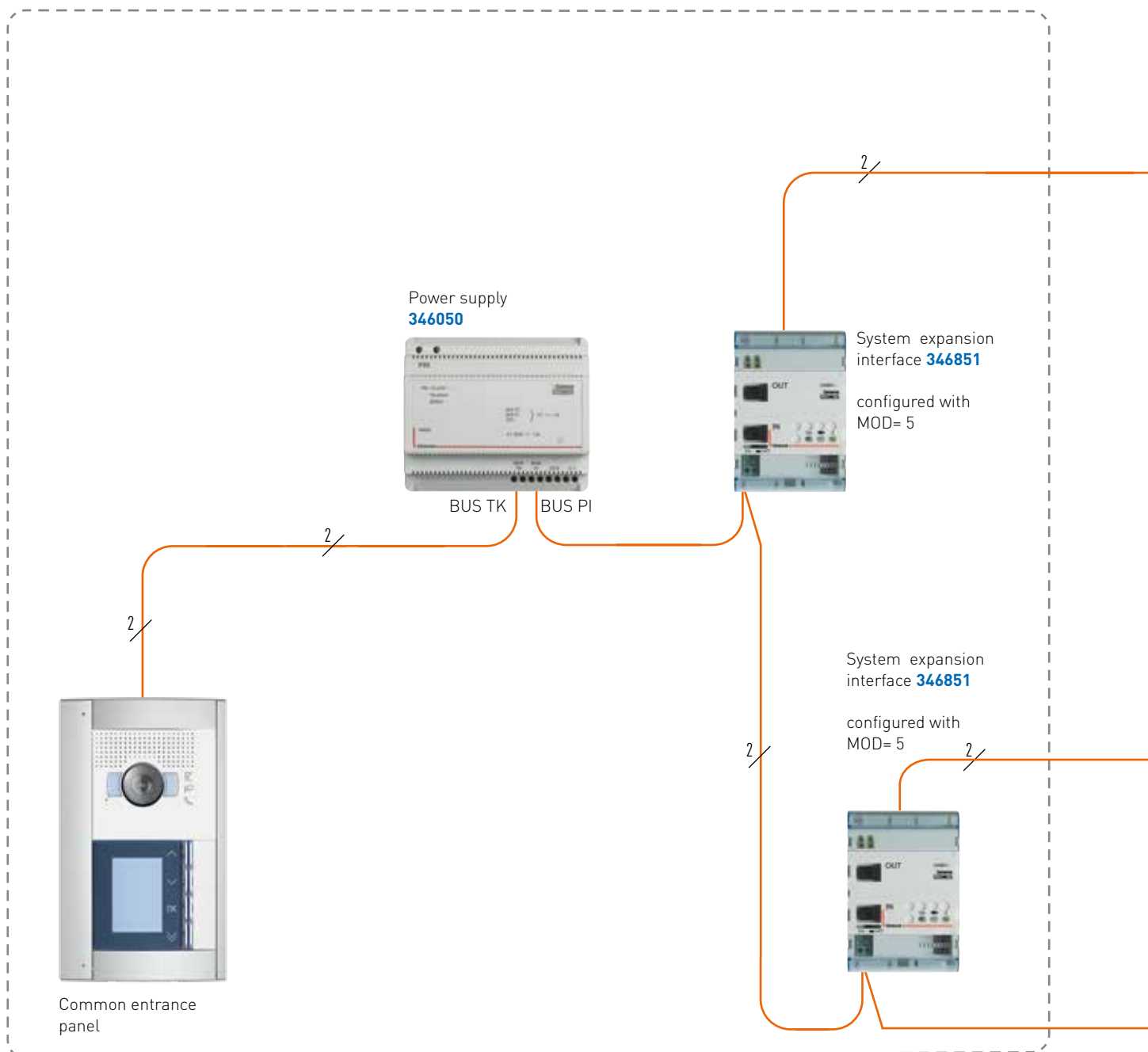

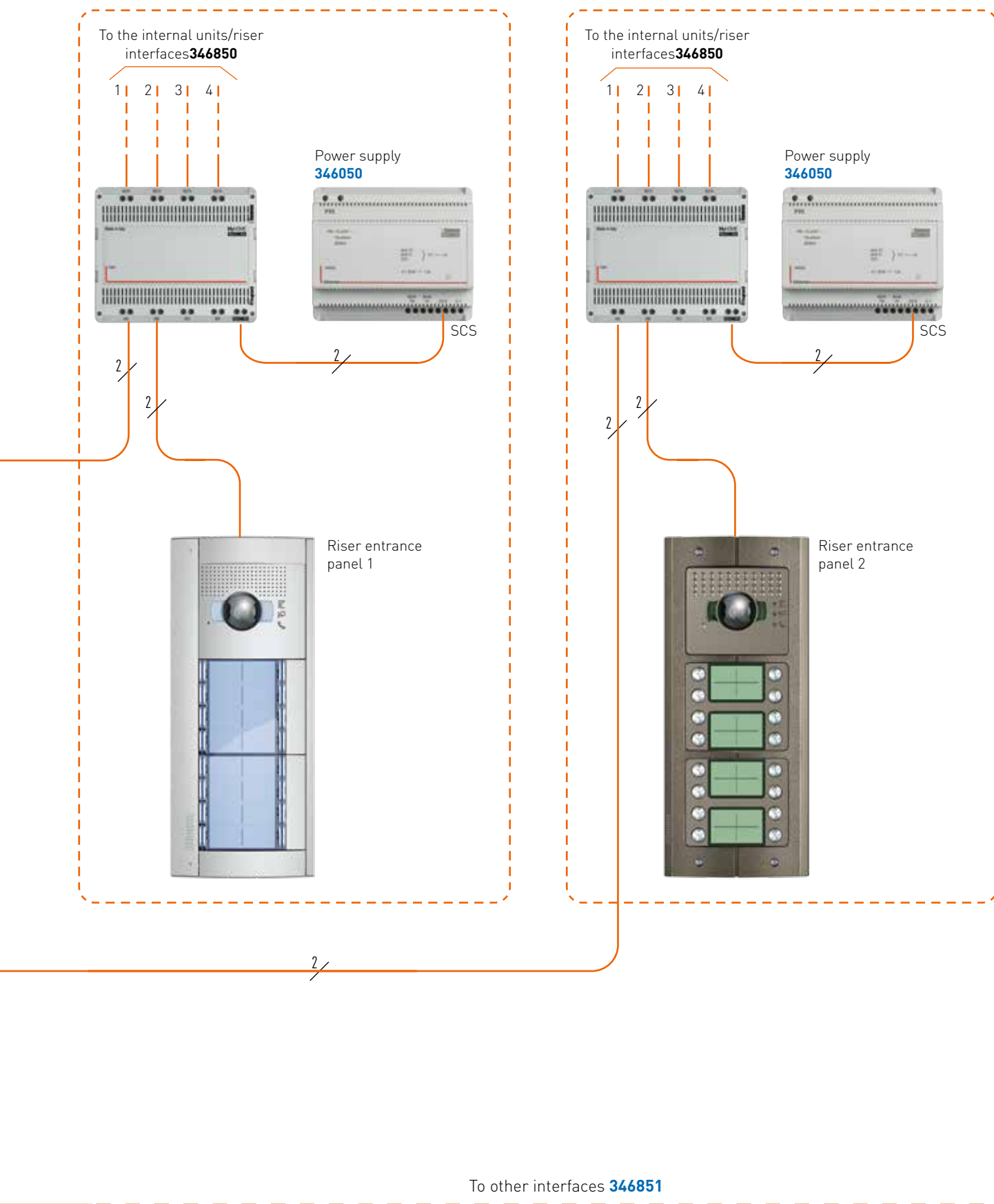

# System expansion with interfaces

## EXAMPLE (1) OF INTERFACE 346851 CONNECTION IN LINE EXPANSION MODE (MOD=0)

It must be used to expand the system, in order to:

- Regenerate the video signal, with the possibility of a further 200 m after the interface (with cable 336904/336905)
- Increase the number of devices connected to the BUS

**Notes:**

- 200 m with BTicino cable 336904/336905
- Up to a maximum of 3 interfaces 346851 in cascade (600 m max.)
- In the (A) line, interface 346851 must be considered as an internal unit
- In the (B) line, interface 346851 must be considered as an entrance panel

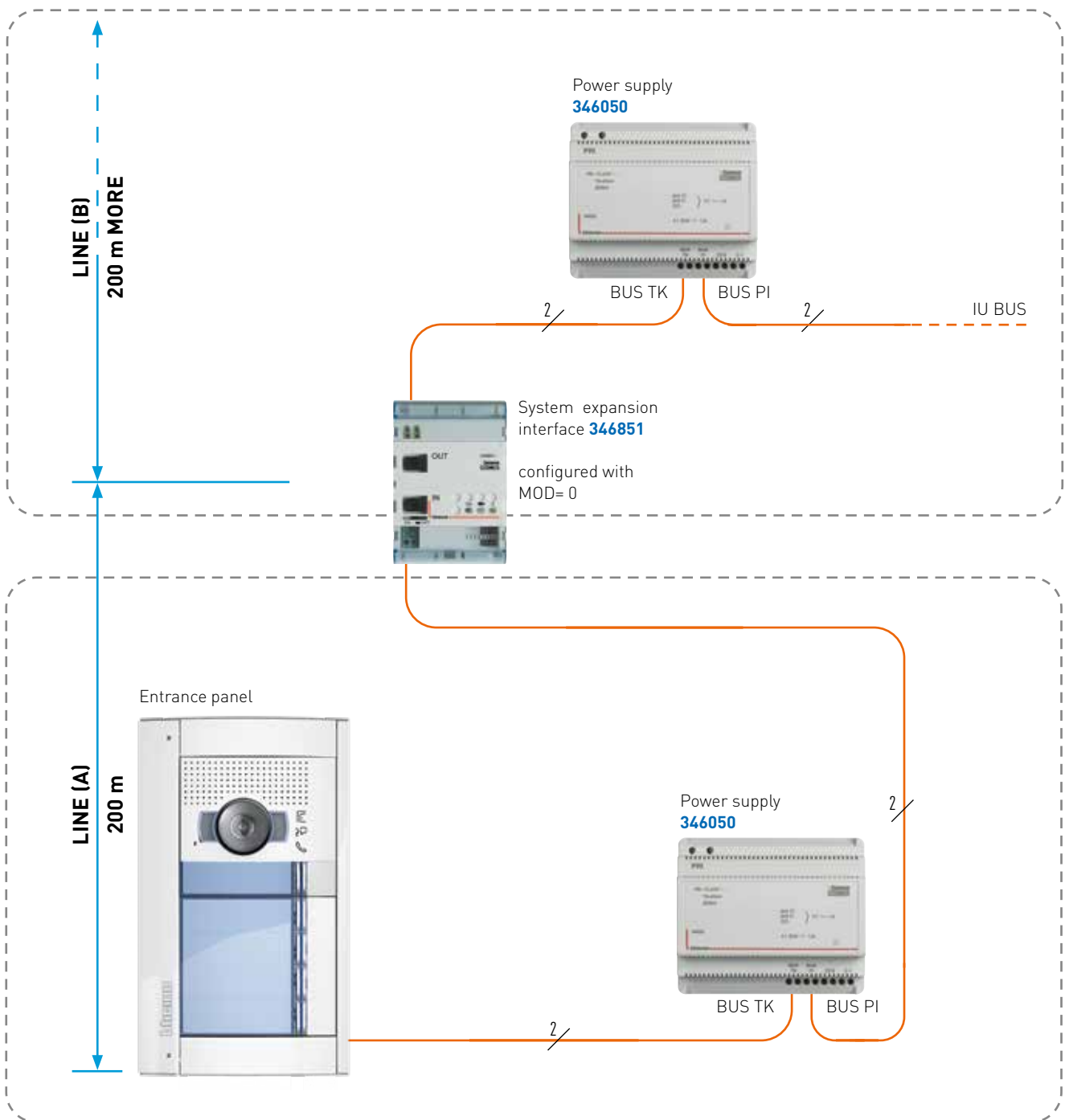

### EXAMPLE (2) OF INTERFACE 346851 CONNECTION IN SYSTEM EXPANSION MODE (MOD=0)

**Notes:**

- in order to reach the maximum distance, it is necessary to use the BTicino cable 336904/336905
- The IN clamp of system expansion modules with MOD = 0 must be connected to a dedicated output of the audio/video node item F441 or the floor shunt 346841 (as an internal unit with local power supply).

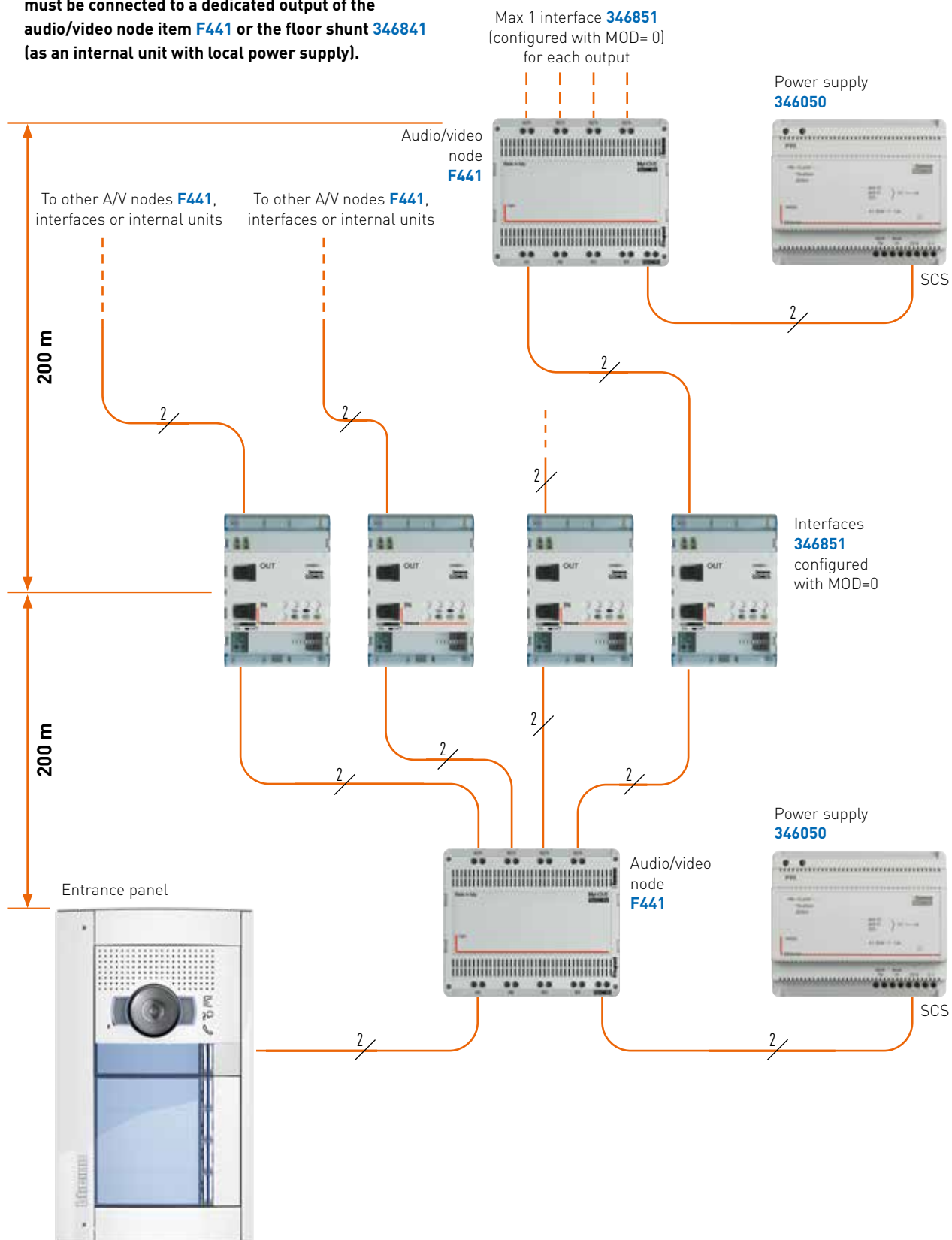

# System expansion with interfaces

## GENERAL RULES FOR DISTANCE CALCULATION

The maximum possible distance for video systems (between the furthest EP and IU) is 600 m when using the BTicino cable [336904/336905](#).

For audio systems, the maximum distance is 1350 m when using 1 mm<sup>2</sup> section sheathed cables. The call signal can cross up to 2 interfaces [346851](#) (and max. 1 apartment interface [346850](#)).

For the calculation of the maximum system distances, it will be necessary to identify the galvanically insulated sections, identify the A, B and C lines of each section, and find on the table (system performance) the maximum permitted distance based on the items installed and the cable used. Below are some examples of identification of the LINES.

## SYSTEM WITH APARTMENT INTERFACE 346850

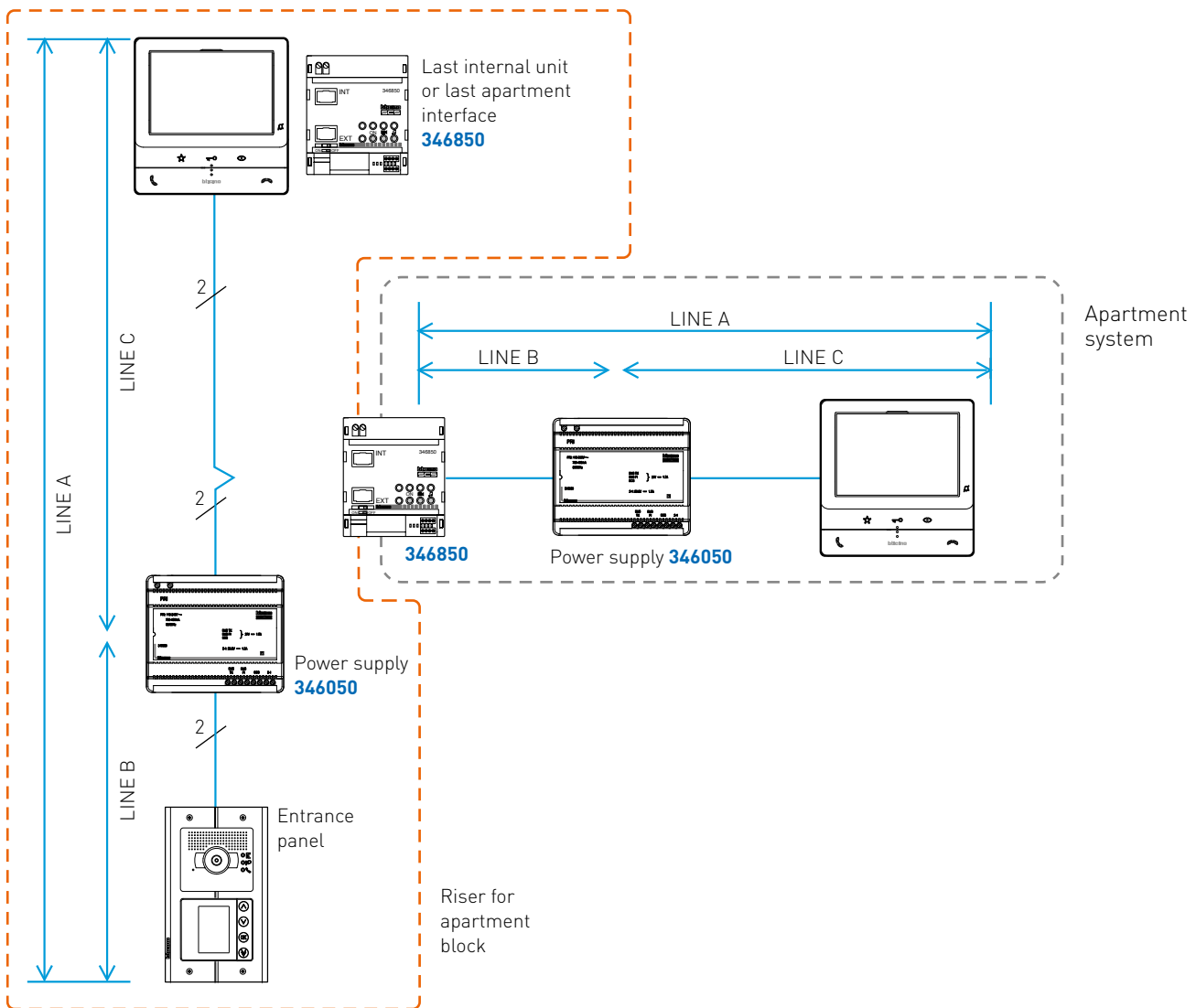

**Note: the apartment block riser and the apartment system are galvanically isolated.**

### SYSTEM IN EXPANSION WITH INTERFACE 346851

It is possible to use a maximum of 3 interfaces 346851 and 346850 in cascade, taking into account that several interfaces 346850 cannot be connected in cascade to each other. By interfaces in cascade, we mean those crossed by an audio / video connection (entrance panel - internal unit). Only two interfaces (any) can repeat the signal, meaning making available another 200 m

on the A LINE. When calculating distances in case of crossing of three interfaces, it must be decided which interface will not repeat the signal. In this mode, it is not considered in the identification of LINE A .

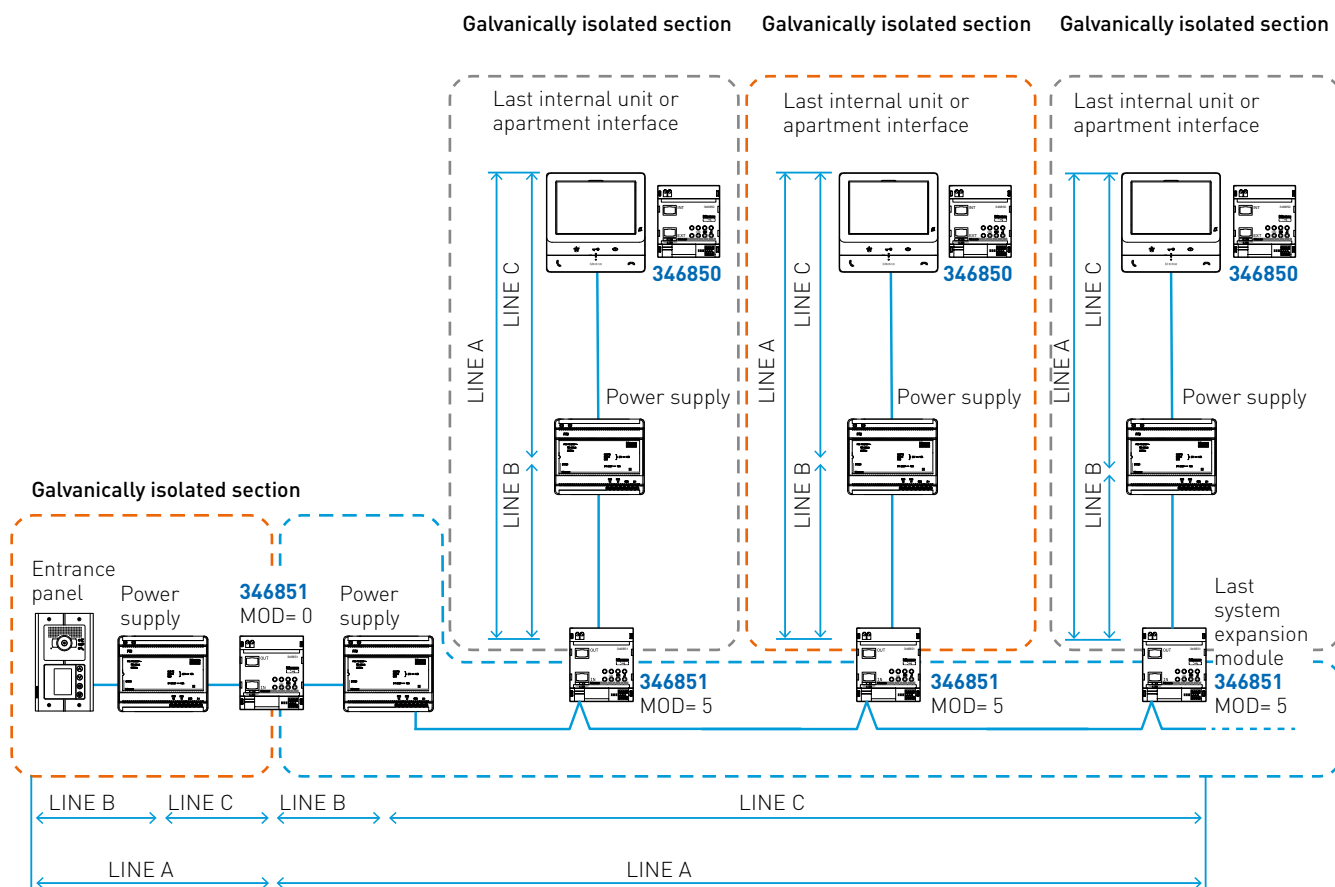

# System expansion with interfaces

## AUDIO SYSTEMS WITH SYSTEM EXPANSION INTERFACE 346851

The system expansion interface gives the possibility of increasing the length of the line of an audio door entry system and/or creating risers with independent audio.

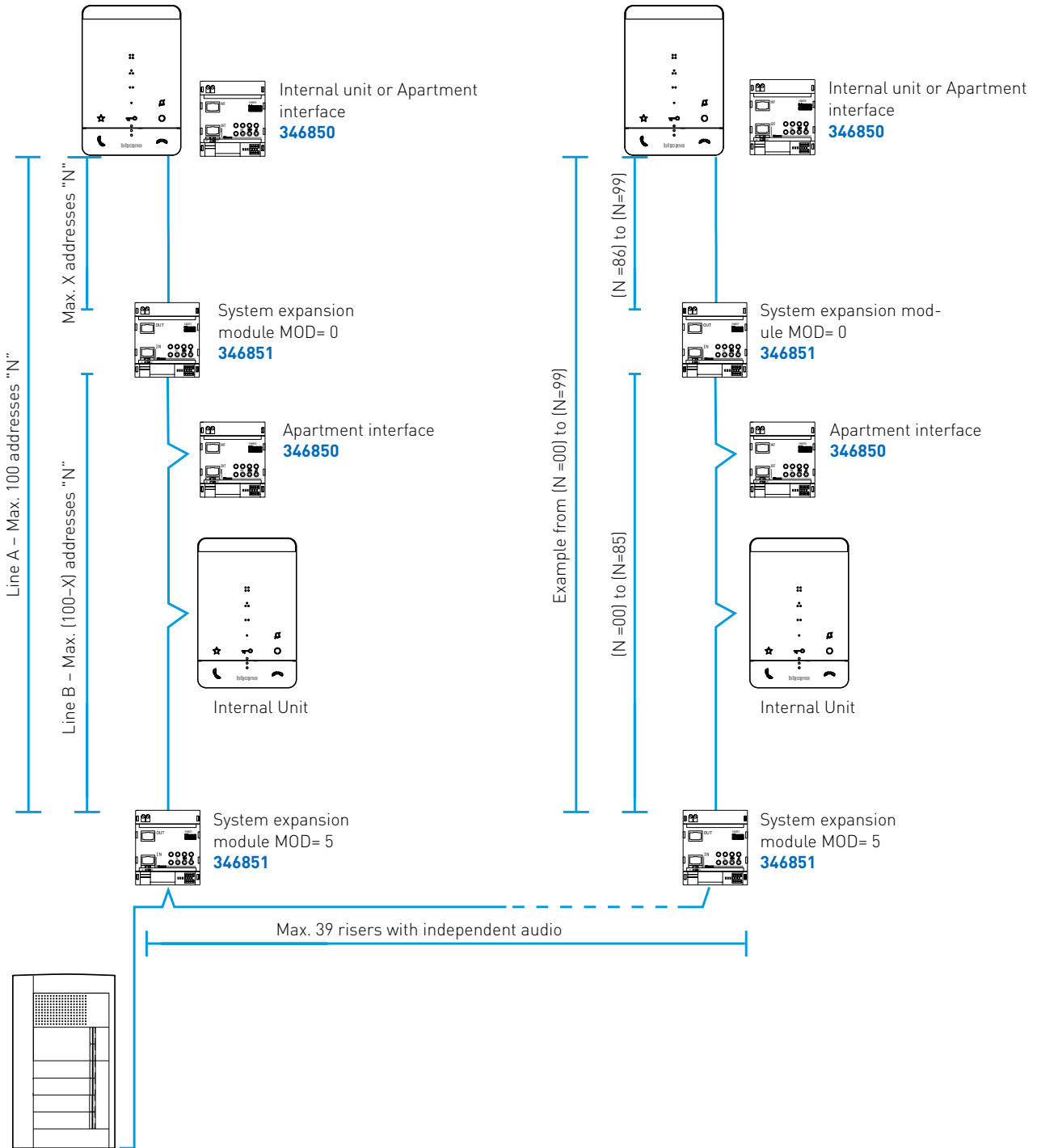



## VIDEO SYSTEMS WITH SYSTEM EXPANSION INTERFACE 346851

The system expansion interface gives the possibility of increasing the length of the line of a video door entry system, of creating risers with independent audio, and of increasing the number of devices that can be connected to the riser.

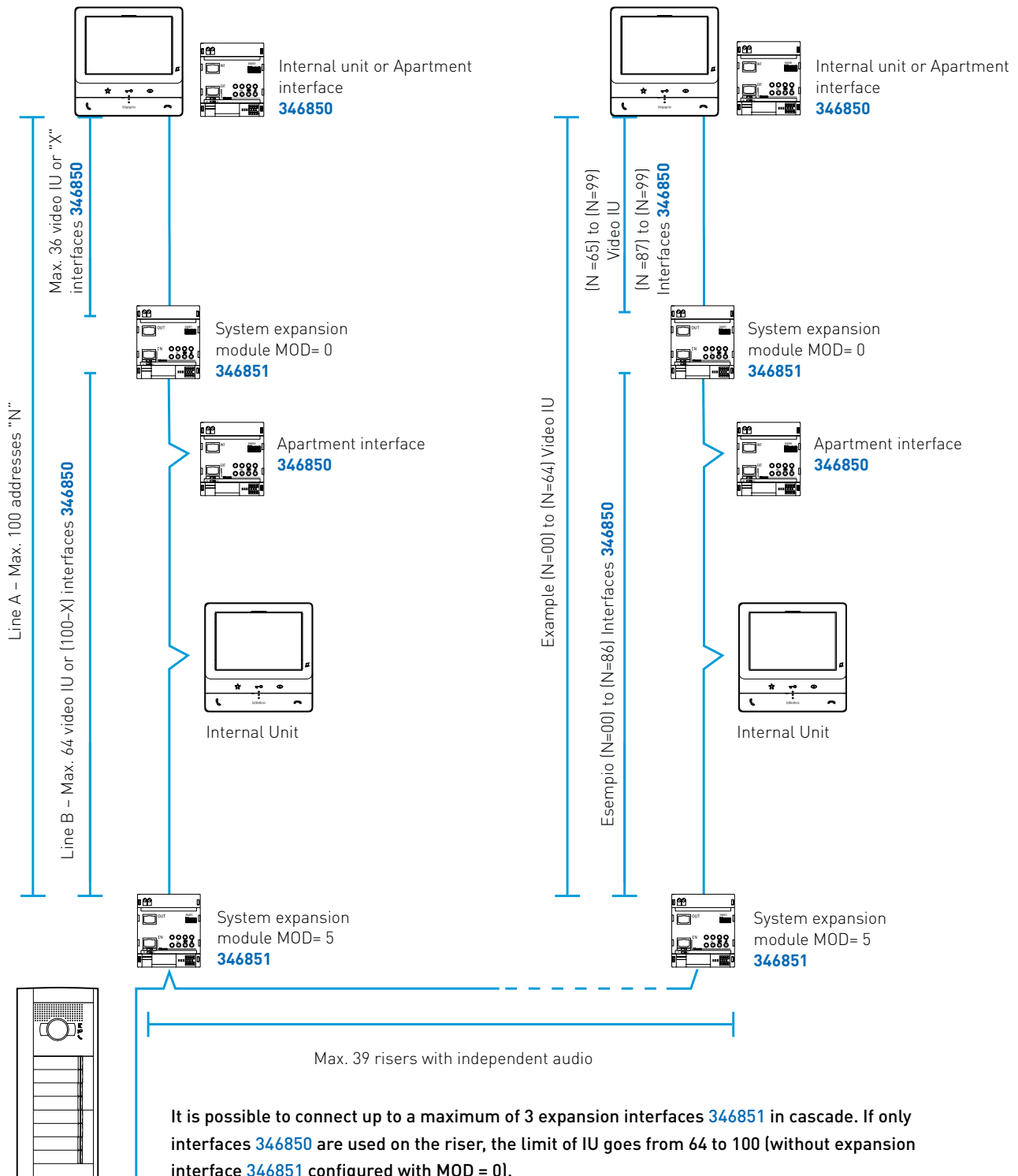

For the calculation of the maximum number of video IU that can be connected to each individual line (without local power supply), we recommend the use of the [YouDiagram](http://www.youdiagram.com) – which can be downloaded free of charge from [www.bticino.com](http://www.bticino.com).

# System expansion with interfaces

## MAXIMUM USE LIMITS FOR INTERFACES 346850 AND 346851

It is possible to connect up to a maximum of 3 expansion interfaces 346850 or 346851 in cascade. By interfaces in cascade, we mean those crossed by an entrance panel / internal unit, or internal unit / internal unit (intercom) audio / video connection.

Only 2 of these (to be chosen by the installer) will repeat the signal for 200 metres; the maximum distance between the entrance panel and the furthest internal unit is 600 m. Each Line (EP / interface, interface / interface, and interface / IU) is 200 m maximum (with BTicino cable 336904/336905).

### EXAMPLE 1

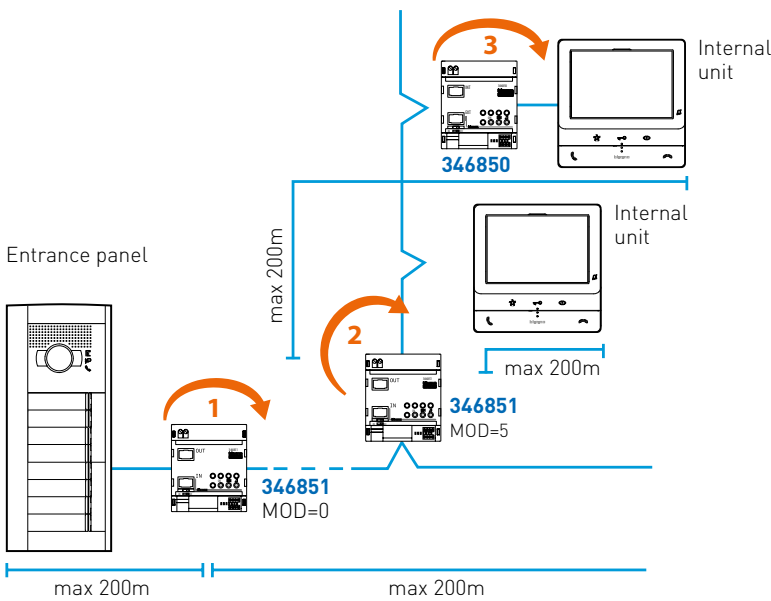

### EXAMPLE 2

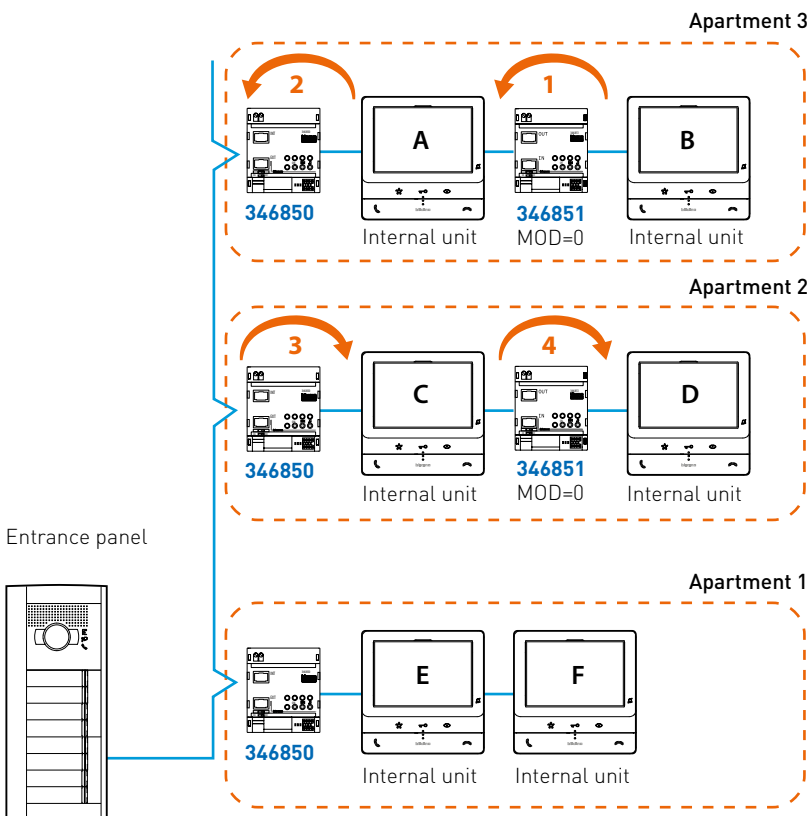

If the Apartment 3 B IU calls apartment 2, all the IU (C and D) of the apartment ring, but answering will only be possible from IU C (IU D is after the 4th interface).



## MAXIMUM USE LIMITS FOR INTERFACE 346891

**CAUTION:** the interface 346891 is NOT compatible with Classe 300EOS and HOMETOUCH internal units.  
ONLY use in systems with Classe 100 internal units.

### SYSTEMS WITH ENTRANCE PANELS ONLY

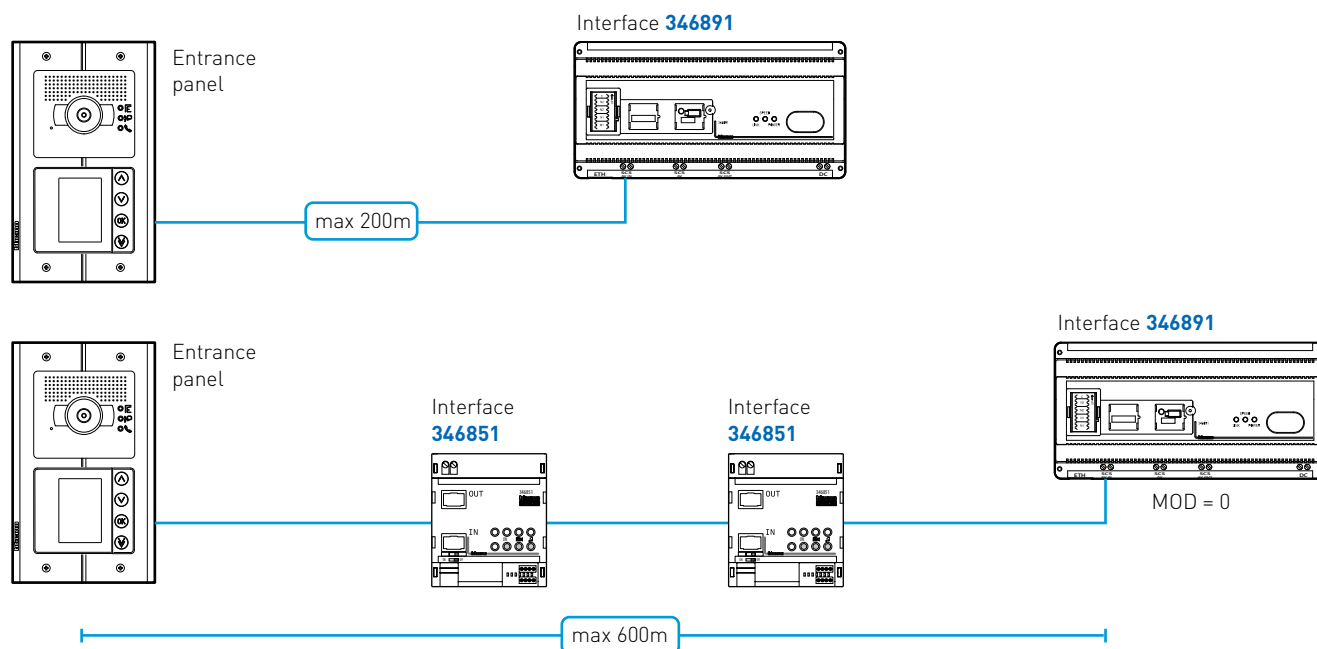

### SYSTEMS WITH INTERNAL UNITS ONLY

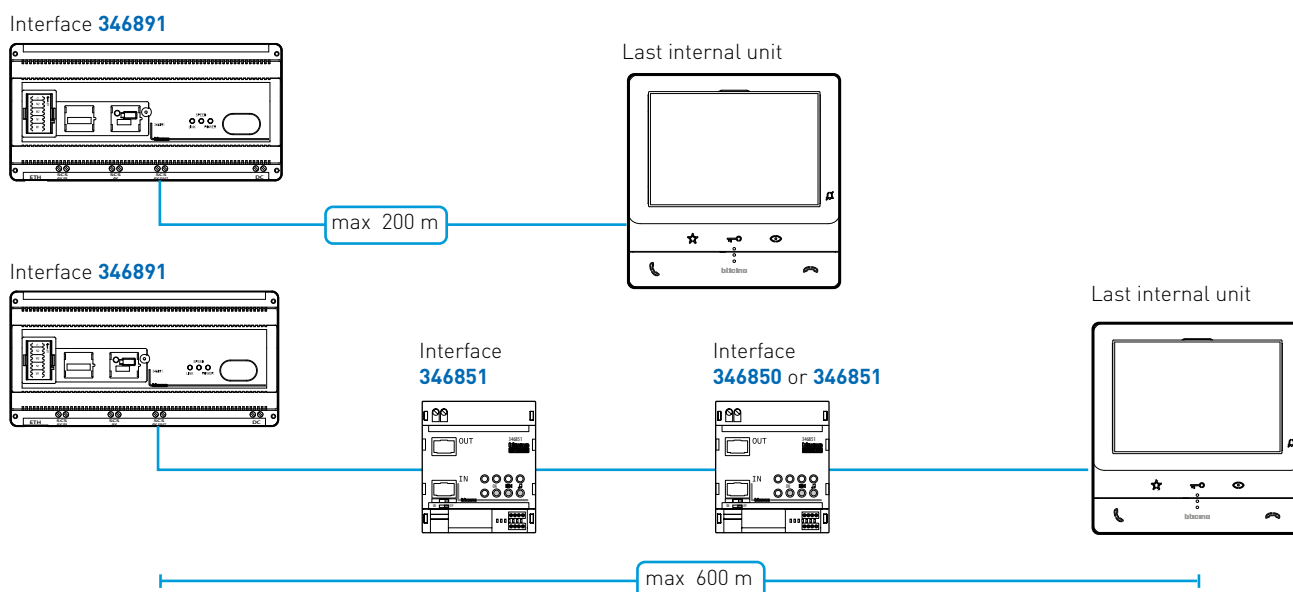

### SYSTEMS WITH ENTRANCE PANELS AND INTERNAL UNITS

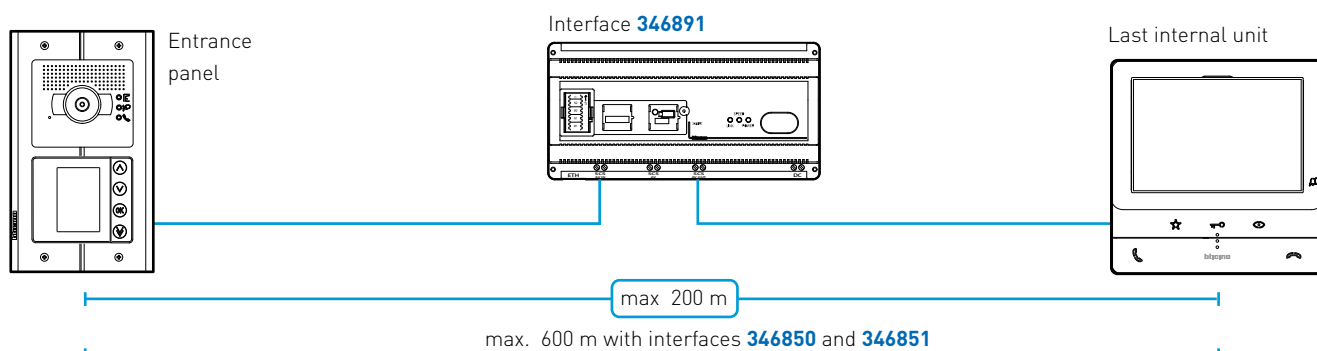

# Configuration of interface 346850

## APARTMENT INTERFACE 346850

The apartment interface is configured as a normal internal unit. It must be uniquely configured. There can be no internal units or interfaces on the same riser configured in (N) with the same address of the interface. Downstream the apartment interface, the internal units must be configured starting from (N=1), as the interface itself generates a general call (S=9). 346850 is configured at the factory with (M=3).

### EXAMPLE

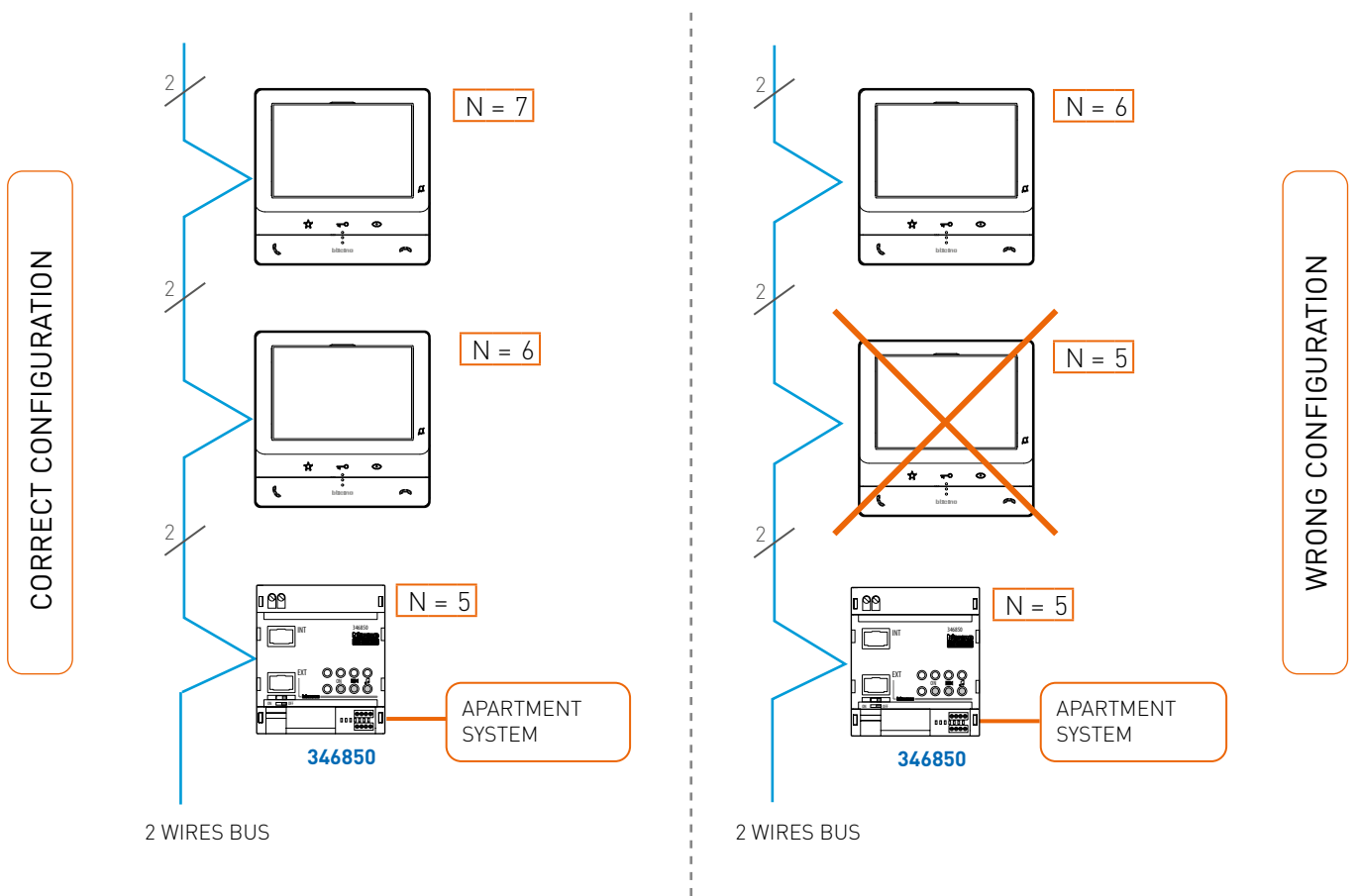

## SYSTEM EXPANSION INTERFACE 346851

The configurator connected to the M socket sets the operating mode as indicated below:

- MOD = 0 (equal to no configurator connected) - LINE EXPANSION MODE / EXPANSION NO. OF DEVICES ON BUS
- MOD = 2 - ENTRANCE PANEL LINE EXPANSION MODE
- MOD = 5 - INDEPENDENT RISERS MODE
- MOD = 6 - EXTENDED RISER MODE
- MOD = 7 - EXTENDED RISER EXPANSION MODE

Interface 346851 configured with (MOD=0) can be used for 2 different purposes.

- Physical line expansion (reachable distances);
- Expansion of the number of devices (EP and IU) that can be connected to the BUS.

### MOD=0 (ELINE EXPANSION)

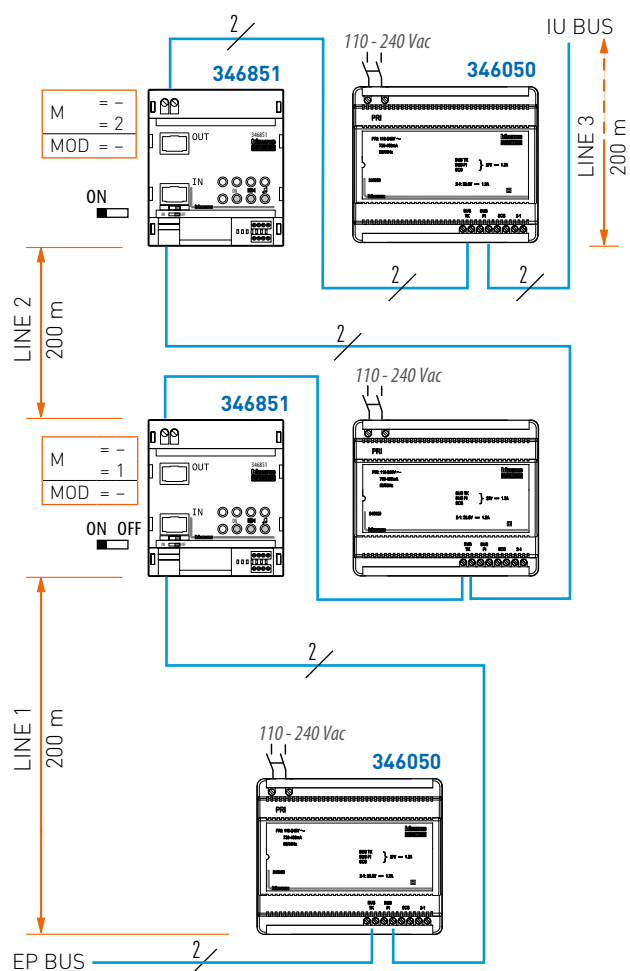

### MOD=0 (EXPANSION NO. OF DEVICES ON RISER)

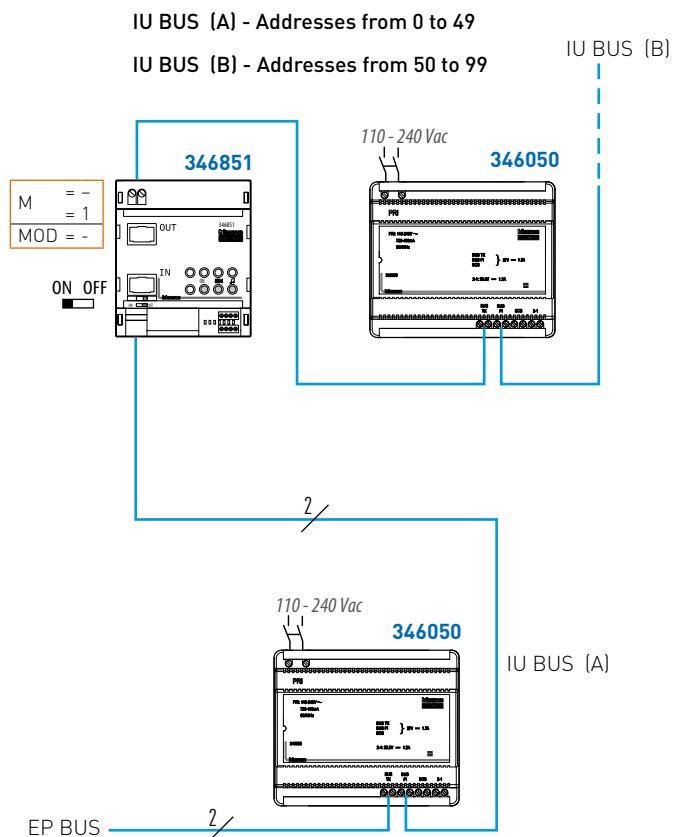

# Configuration of interface 346851

## MOD = 2 (ENTRANCE PANEL LINE EXPANSION)

This mode is used in systems with interface connection between the entrance panel and the F441 audio/video node, to expand the line of the entrance panel.

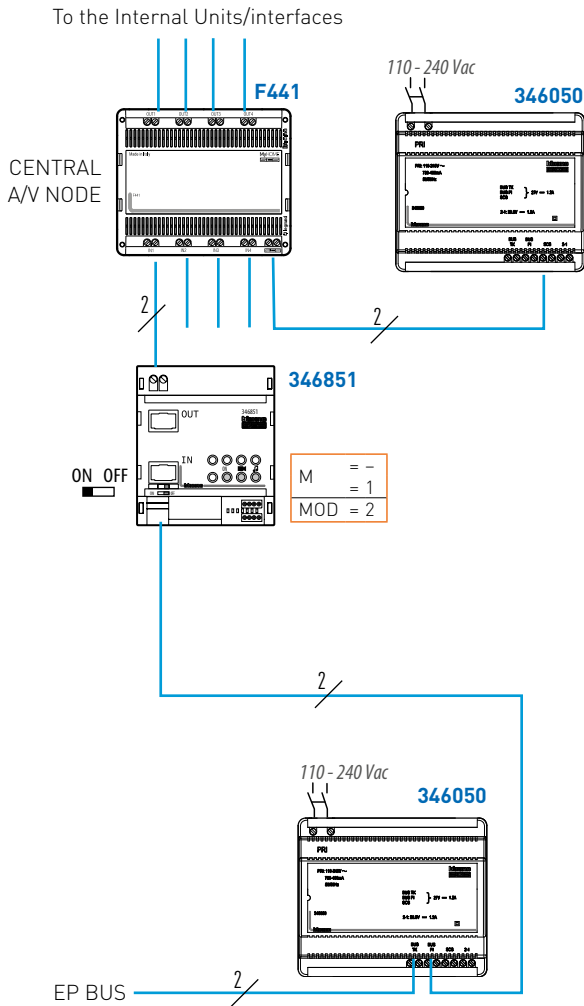

## MOD= 5 (RISERS WITH INDEPENDENT AUDIO)

Independent audio means that each EP can call 1 IU of the riser. In this way, it is possible to have up to 39 audio/video conversations at the same time.

(M) is the progressive unique number that identifies the riser.

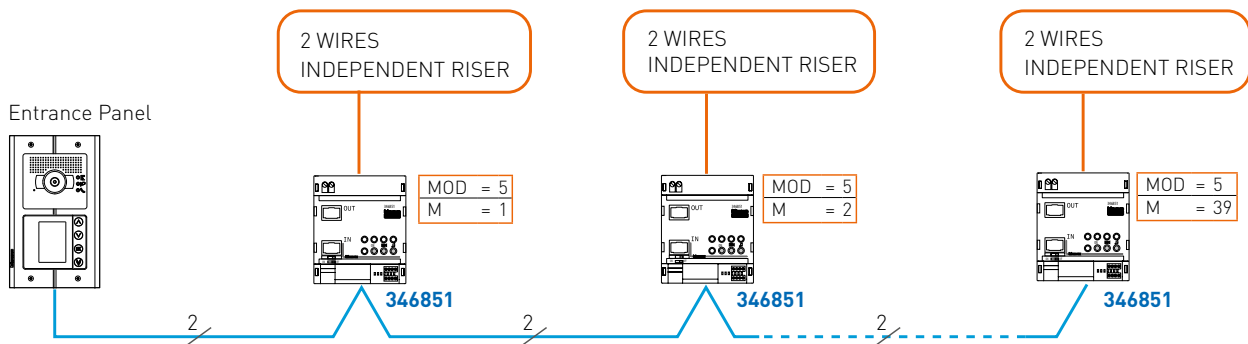

**MOD = 6 (EXTENDED RISER)**

**MOD = 7 (EXTENDED RISER EXPANSION)**

These configuration modes (used together), give the possibility of expanding the riser line up to the logic limit of 300 riser internal units (3 lines of 100 audio IU each). In video or mixed audio/video systems, for the first 2 lines the limit of 100 IU is subjected to the use of apartment interface 346850; the third line reaches the maximum limit of 64 video IU.

It is NOT possible to install apartment interfaces 346850 on the third riser line.

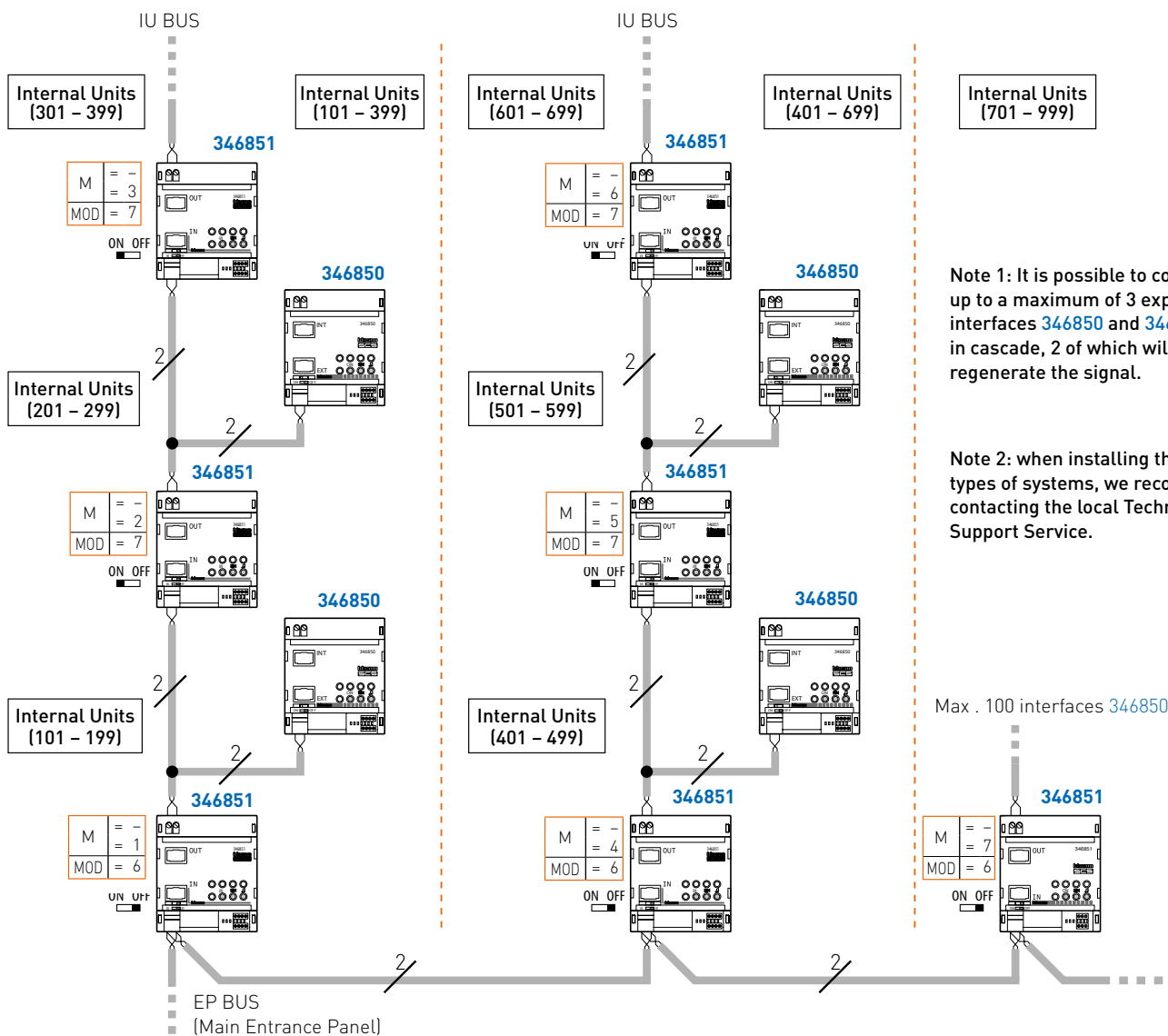

# Configuration of interface 346891

The device must be configured in one of the two available modes:

- Physical configuration (with configurator connection)
- Software configuration using the appropriate application MyHOME\_Suite (that can be downloaded free of charge from the website [www.homesystems-legrandgroup.com](http://www.homesystems-legrandgroup.com)). This mode has the advantage of offering many more options when compared with the physical configuration.

The following parameters must be configured:

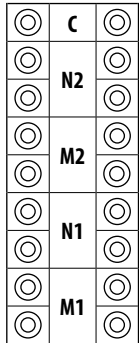

- M1** first part of the minimum internal unit address (00 - 99 - OFF) (\*)
- N1** second part of the minimum internal unit address (00 - 99)
- M2** first part of the maximum internal unit address (00 - 99)
- N2** second part of the maximum internal unit address (00 - 99)
- C** IP guard station address (1 - 9)

NOTE (\*) If M1 = OFF, all the other sockets (N1, M2, N2) must not be configured: only entrance panels must be connected to the interface.

When the interface configuration is completed using physical configurators, the physical address and the system address are the same.

The advanced configuration using MyHOME\_Suite makes it possible to exceed the 2 WIRES system address limit. This is possible thanks to the allocation of a local basic address to IU (internal units) and EP (entrance panels). These addresses make it possible to increase the maximum number of IU and EP that can be managed by the video door entry system.

The physical configuration gives the user the possibility of accessing 3 operating modes:

**MODE 1 - The device only manages automatically detected entrance panels and cameras.**

The IP guard station number called (1-9) is inserted in the C socket.

**MODE 2 - The device manages internal units with configurations between N1 and N2 and automatically detected entrance panels/cameras.**

This configuration is used in installations with risers with a low number of internal units and low address. The IP guard station number called (1-9) is inserted in the C socket.

**MODE 3 - The device manages internal units with address between  $M1 \times 100 < IU < (M1 \times 100) + 99$ .**

The IP guard station number called (1-9) is inserted in the C socket. With this configuration mode, the maximum number of devices that can be connected to the individual interface is 95 entrance panels and 3900 internal units.

**NOTE: interface 346891 is configured at the factory with “forcing of call to the guard station” ACTIVE.**

**If the device is configured using physical configurators, calls from the entrance panel to the internal units are not allowed.**



The advanced PC configuration using MyHOME\_Suite enables the implementation of a higher number of functions, the customisation of text and the complete use of the system performance levels.

To transfer the configuration made with the MyHOME\_Suite software or update the device firmware, connect interface 346891 to the PC using a USB-micro USB cable.

The MyHOME\_Suite software can be downloaded free of charge from the website: [www.homesystems-legrandgroup.com](http://www.homesystems-legrandgroup.com).

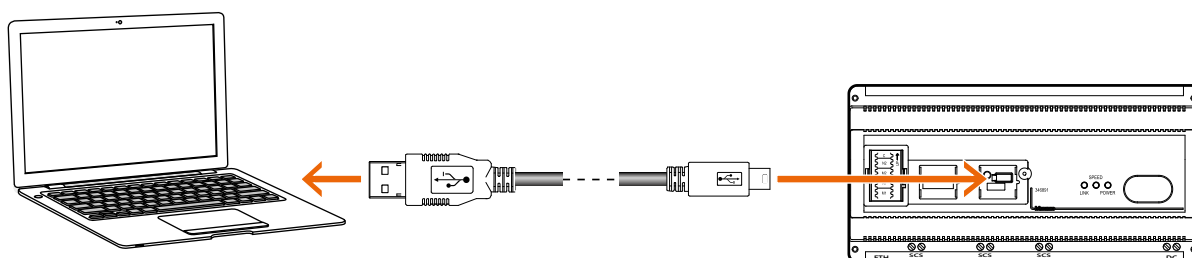

Interface performance according to the different configuration modes:

	Physical	Advanced
Max. No. of IU of the system (audio or video)	3900	10000
Max. No. of EP of the system	95	1000
Maximum address that can be called from the EP	4000	10000
Max. No. of IP devices	100 (Note 1)	100 (Note 1)
Max. No. of IP guard stations	9	max. 100 IP devices (Note 2)
Advanced management of the physical and system addresses	NO	YES
Check the consistency of the configuration	YES (Note 3)	YES
Entrance Panel - Internal Unit direct call	NO	YES
Switching on readdressing	NO	YES
Camera scrolling	NO	YES

**Note 1:** the IP guard station can "weight" 2 to 4 IP devices as far as the activation or not of the Alarm logger and Alarm manager services of the IP guard station itself;

**Note 2:** maximum no. of IP guard stations that can be installed, within the limit of 100 IP devices maximum, taking into account what indicated in Note 1;

**Note 3:** the test must be completed using the "MyHOME\_Suite" software.

**CAUTION:** the interface is NOT compatible with Classe 300EOS and HOMETOUCH internal units.

**ONLY use in systems with Classe 100 internal units.**

# Wiring rules for Classe 300EOS / Classe 100X connected video internal units

## ONE-FAMILY INSTALLATION



- it does NOT require additional power supply of the Classe 300EOS / Classe 100X video internal unit
- Max 5 IU (of which ONLY 1 with call repetition on smartphone using the App).

## TWO-FAMILY INSTALLATION

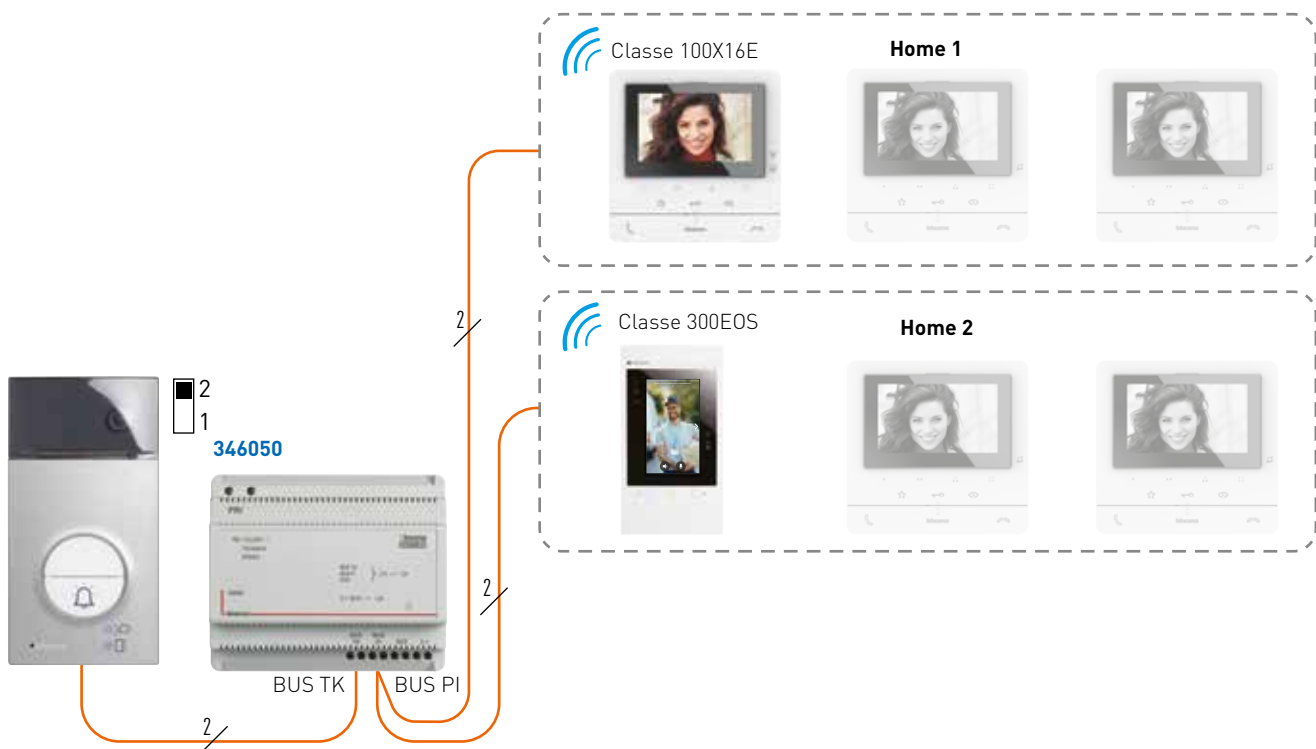

- it does NOT require additional power supply of the Classe 100X video internal units
- ALL the Classe 300EOS video internal units require additional power supply
- ONLY 1 Classe 300EOS video internal unit with Home + Security App
- ONLY 1 Classe 300EOS / Classe 100X for each apartment
- ONLY 1 Classe 300EOS / Classe 100X for each local network
- Max. 3 IU per apartment (of which ONLY 1 with call repetition on smartphone using the App).

**MULTIFAMILY INSTALLATION – APARTMENT BLOCKS TYPE 1**

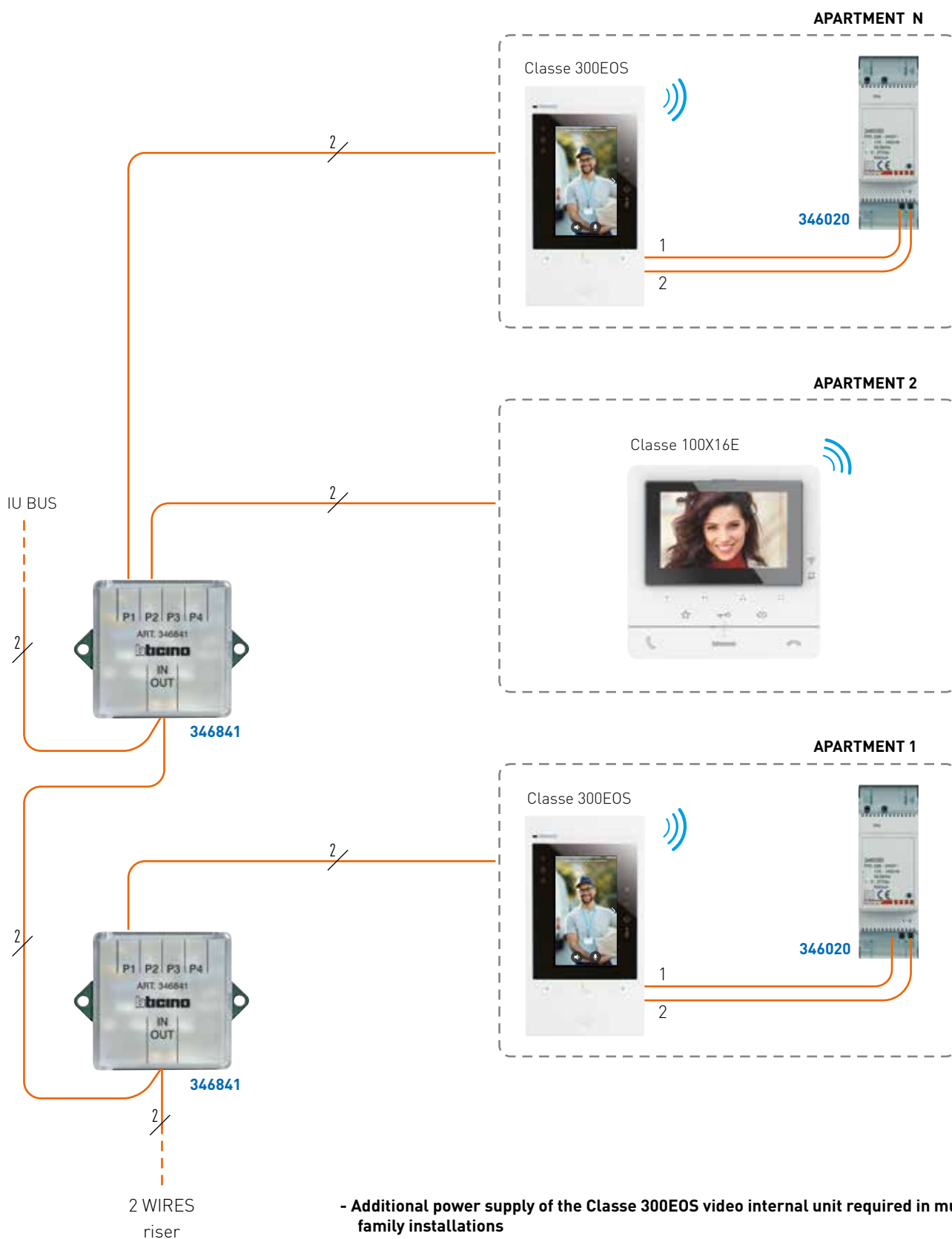

- Additional power supply of the Classe 300EOS video internal unit required in multi-family installations
- ONLY 1 Classe 100X internal unit for each local network
- ONLY 1 Classe 300EOS video internal unit with Home + Security App

# Wiring rules for Classe 300EOS / Classe 100X connected video internal units

## MULTIFAMILY INSTALLATION – APARTMENT BLOCKS TYPE 2

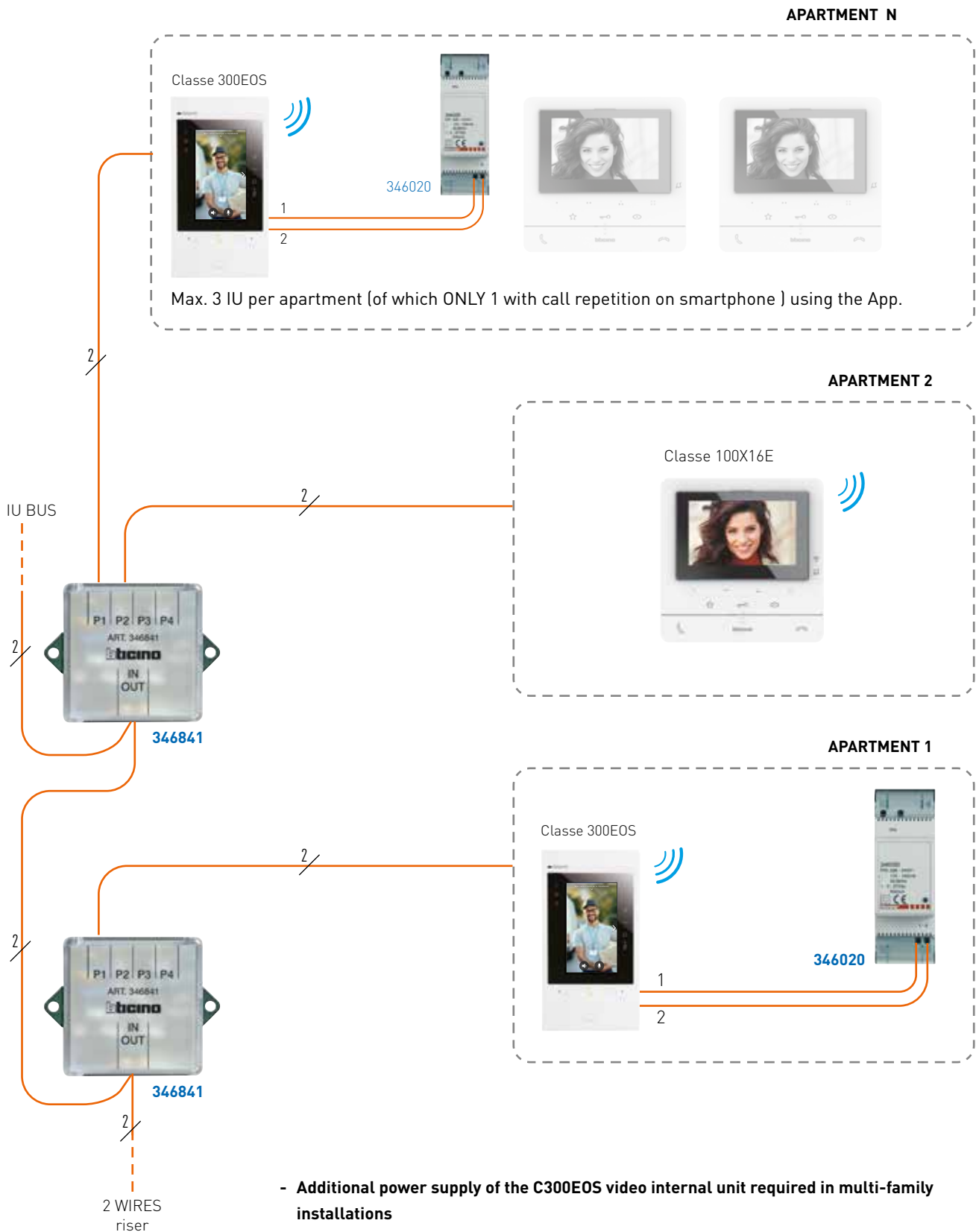

- Additional power supply of the C300EOS video internal unit required in multi-family installations
- ONLY 1 Classe 100X for each apartment
- ONLY 1 Classe 100X for each LAN local network
- ONLY 1 Classe 300EOS video internal unit with Home + Security App

**MULTIFAMILY INSTALLATION – APARTMENT BLOCKS TYPE 3**

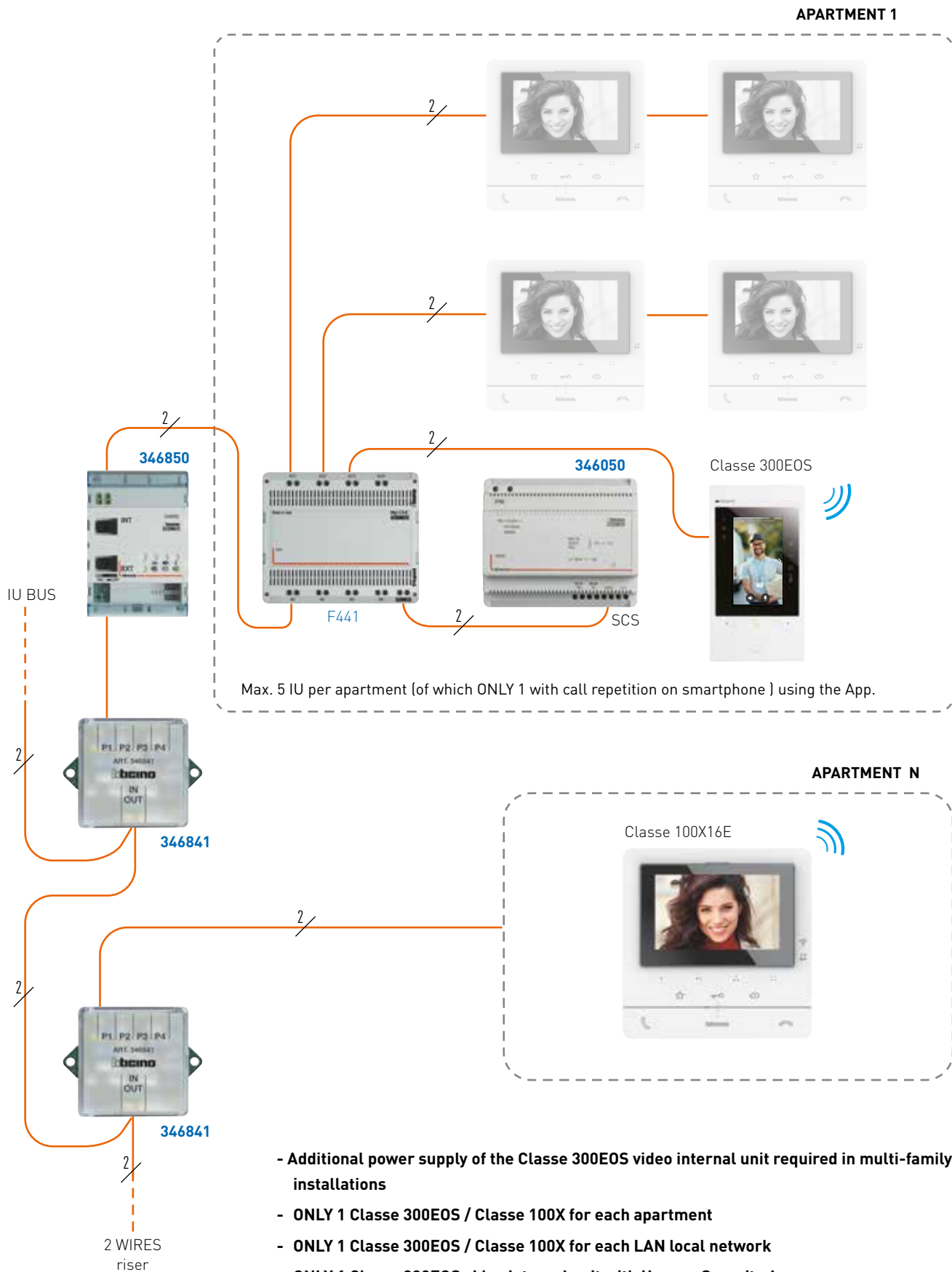

- Additional power supply of the Classe 300EOS video internal unit required in multi-family installations
- ONLY 1 Classe 300EOS / Classe 100X for each apartment
- ONLY 1 Classe 300EOS / Classe 100X for each LAN local network
- ONLY 1 Classe 300EOS video internal unit with Home + Security App

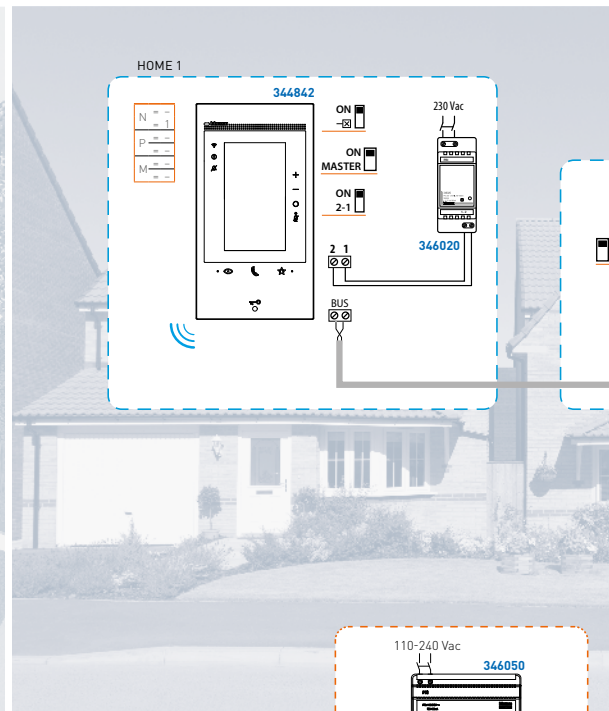
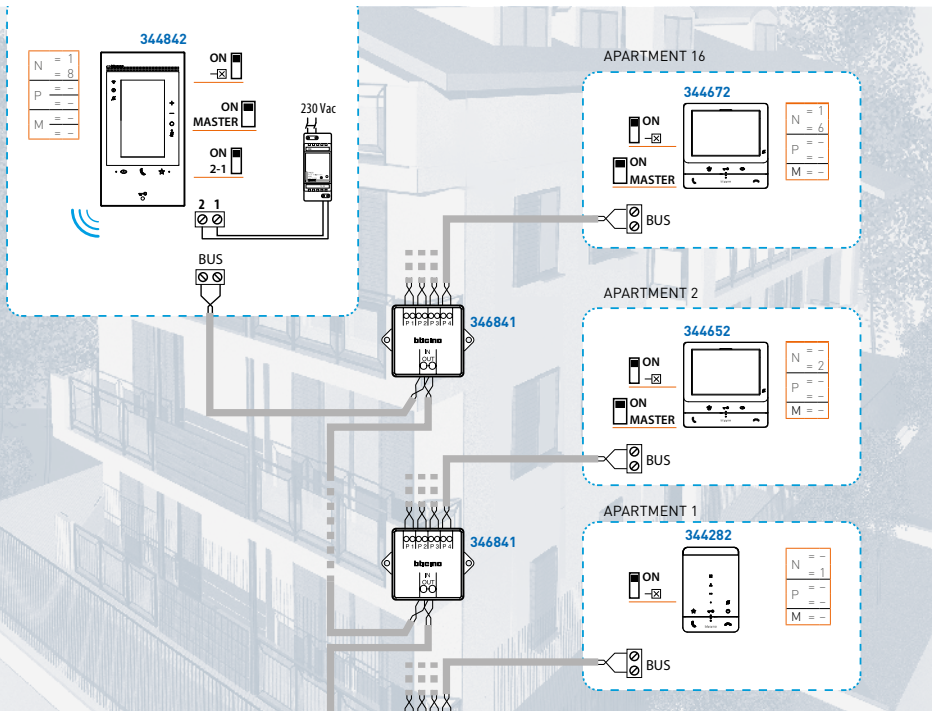

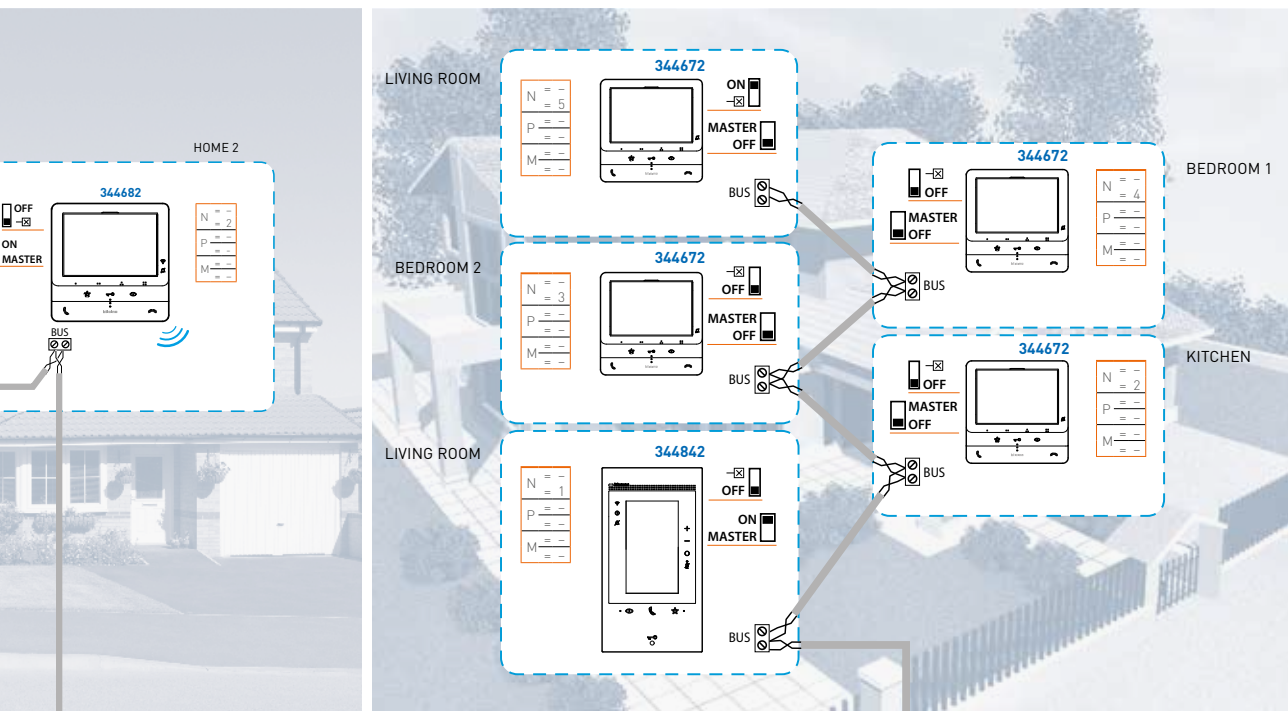

# 3 WIRING DIAGRAMS

# Example 1 - The villa

## ONE FAMILY VIDEO DOOR ENTRY SYSTEM WITH SMARTPHONE CALL REPETITION AND DOOR LOCK RELEASE KEY CARD

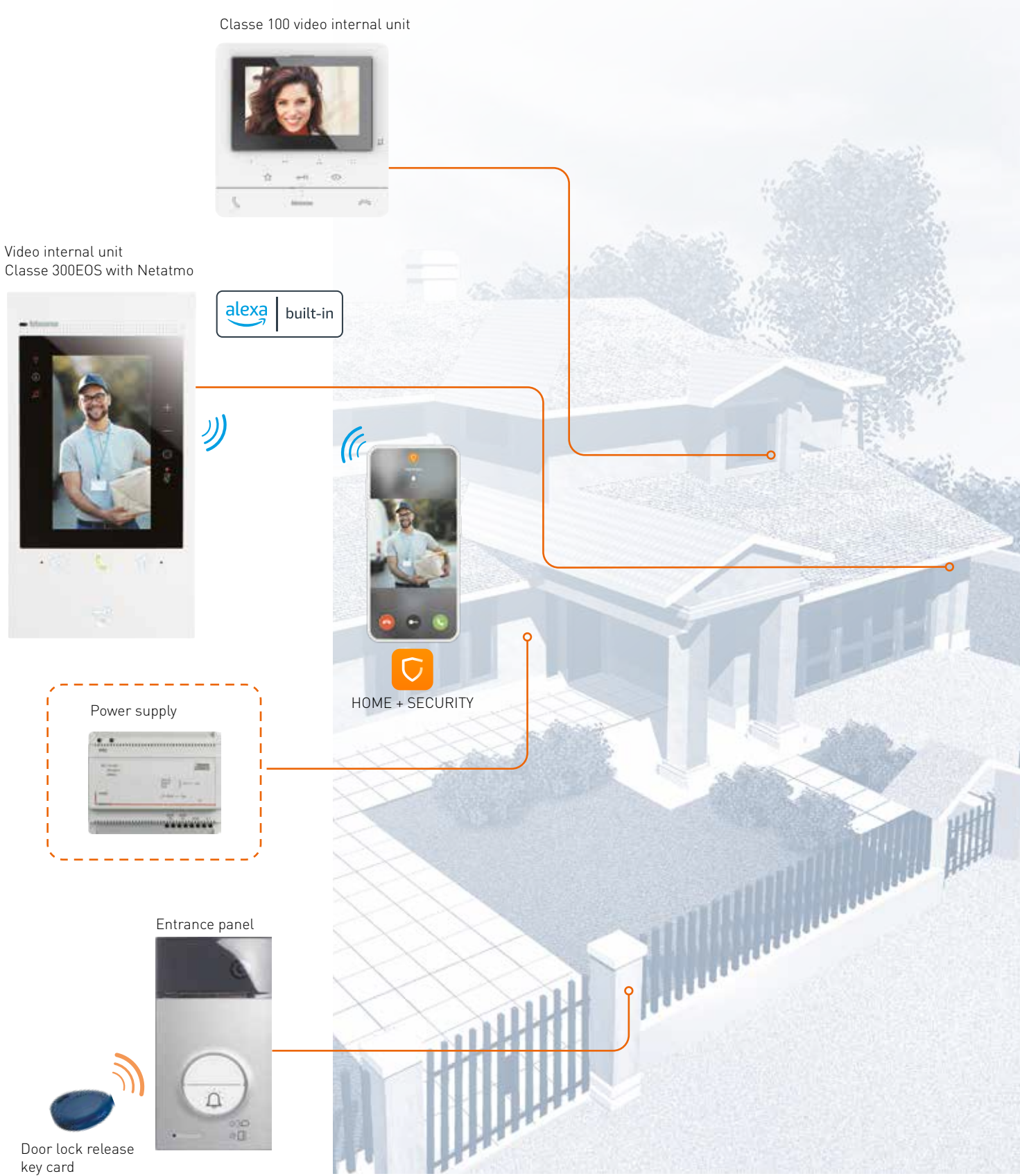



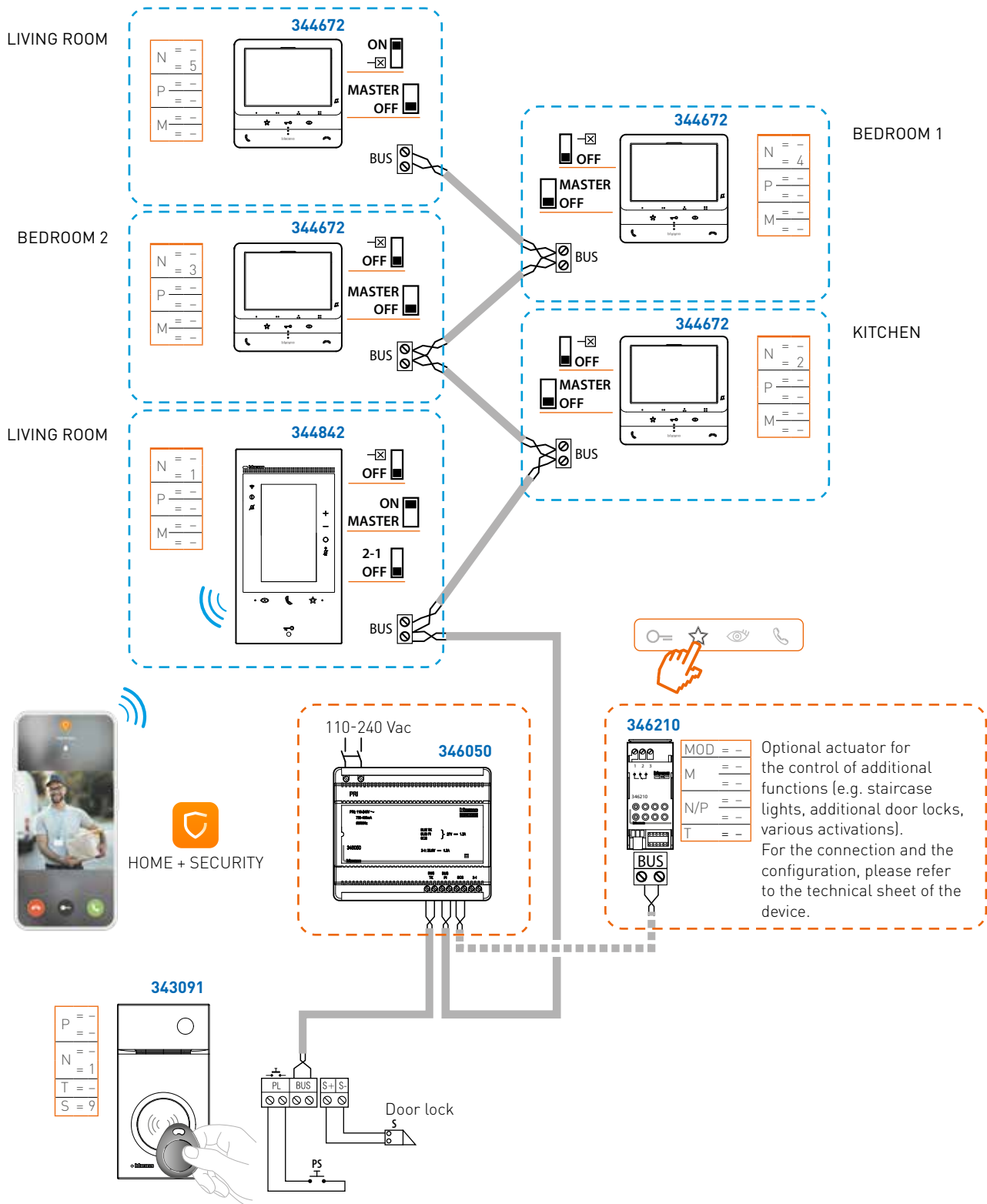

- Max. 5 internal units;
- Max. 200 m between the entrance panel and the last internal unit with cable 336904 / 336905;
- Max 110 m between the power supply and the last internal unit with cable 336904 / 336905;
- A domestic Wi-Fi with internet access is needed for the connection between the CLASSE 300EOS with Netatmo connected video internal unit and the smartphone;
- When the call is received, only the video door entry system configured with N=1 that forwards the call to the smartphone switches on (after appropriate configuration);
- CLASSE 300EOS internal unit must be installed ONLY in systems made with BTicino 2 wires technology.

# Example 2 - The two-family villa

## TWO-FAMILY VIDEO DOOR ENTRY SYSTEM WITH SMARTPHONE CALL REPETITION

Video internal unit  
Classe 300EOS with Netatmo  
HOME 1



Classe 100X video internal unit  
HOME 2

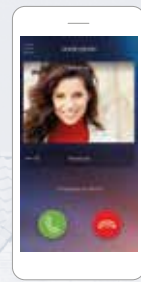

HOME + SECURITY



DOOR ENTRY

Power supply



ENTRANCE PANEL



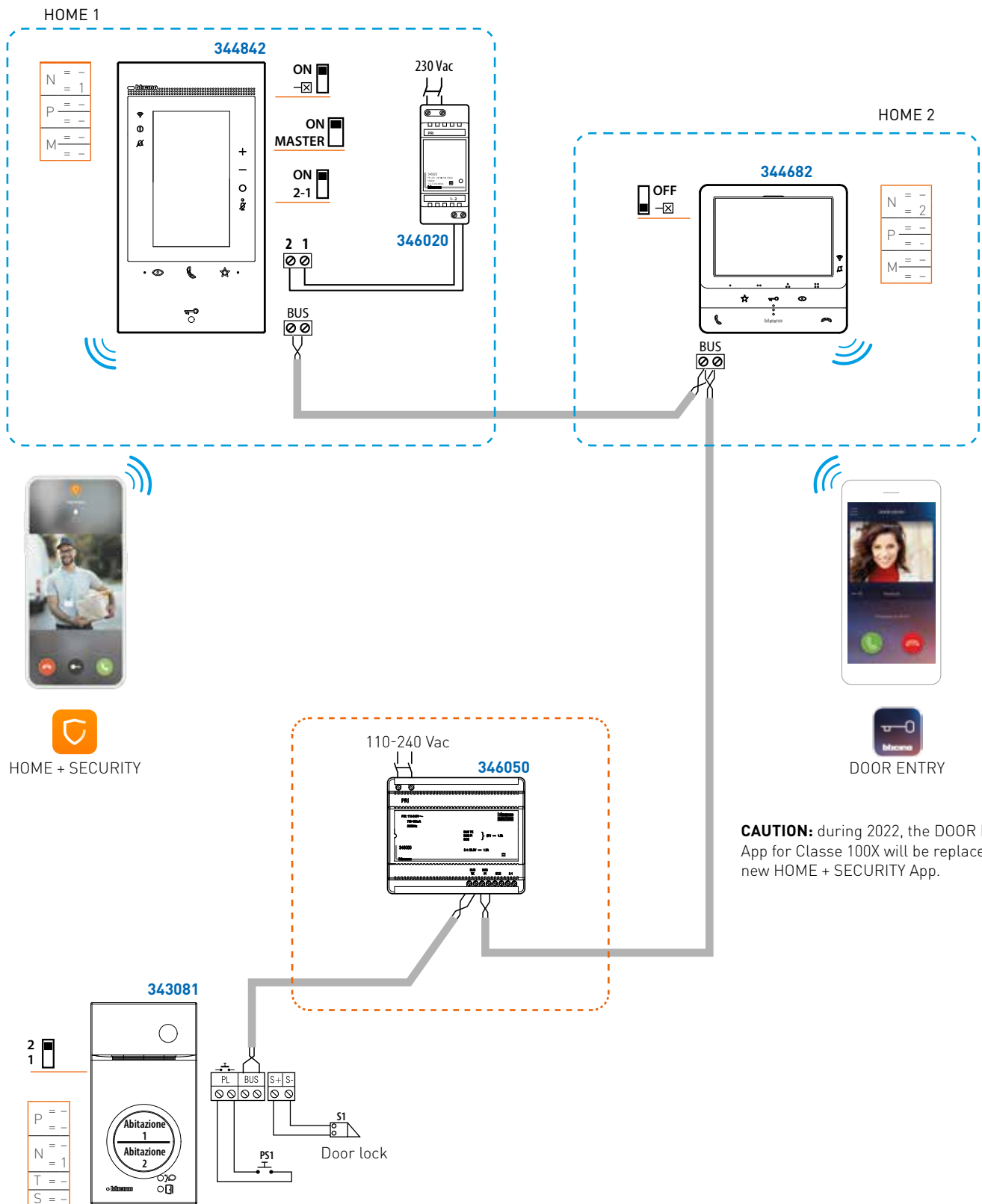

- Max. 3 internal units for each dwelling;
- Max. 200 m between the entrance panel and the last internal unit with cable 336904 / 336905;
- Max. 1 CLASSE 300EOS with Netatmo / CLASSE100X video internal unit connected for each local LAN;
- A domestic Wi-Fi with internet access is needed for the connection between the CLASSE 300EOS with Netatmo / Classe 100X connected video internal unit and the smartphone.
- In multi-family installations, the connected CLASSE 300EOS with Netatmo video internal unit must be powered locally;
- CLASSE 300EOS with Netatmo / CLASSE 100X internal units must be installed ONLY in systems made with BTicino 2 wires technology.

# Example 3 - The apartment building

## AUDIO DOOR ENTRY, VIDEO DOOR ENTRY OR MIXED MULTIFAMILY SYSTEMS WITH SMARTPHONE CALL REPETITION

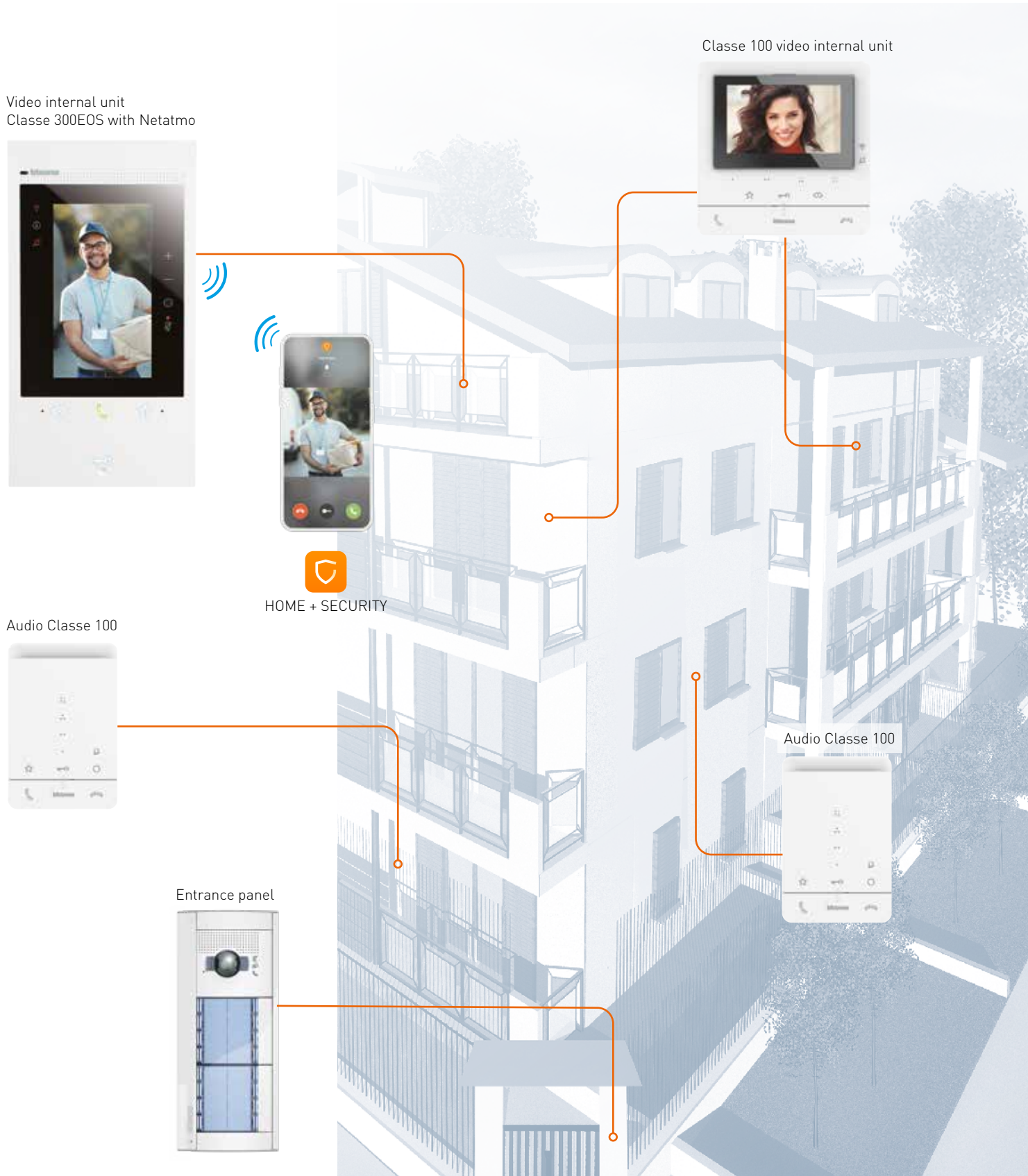

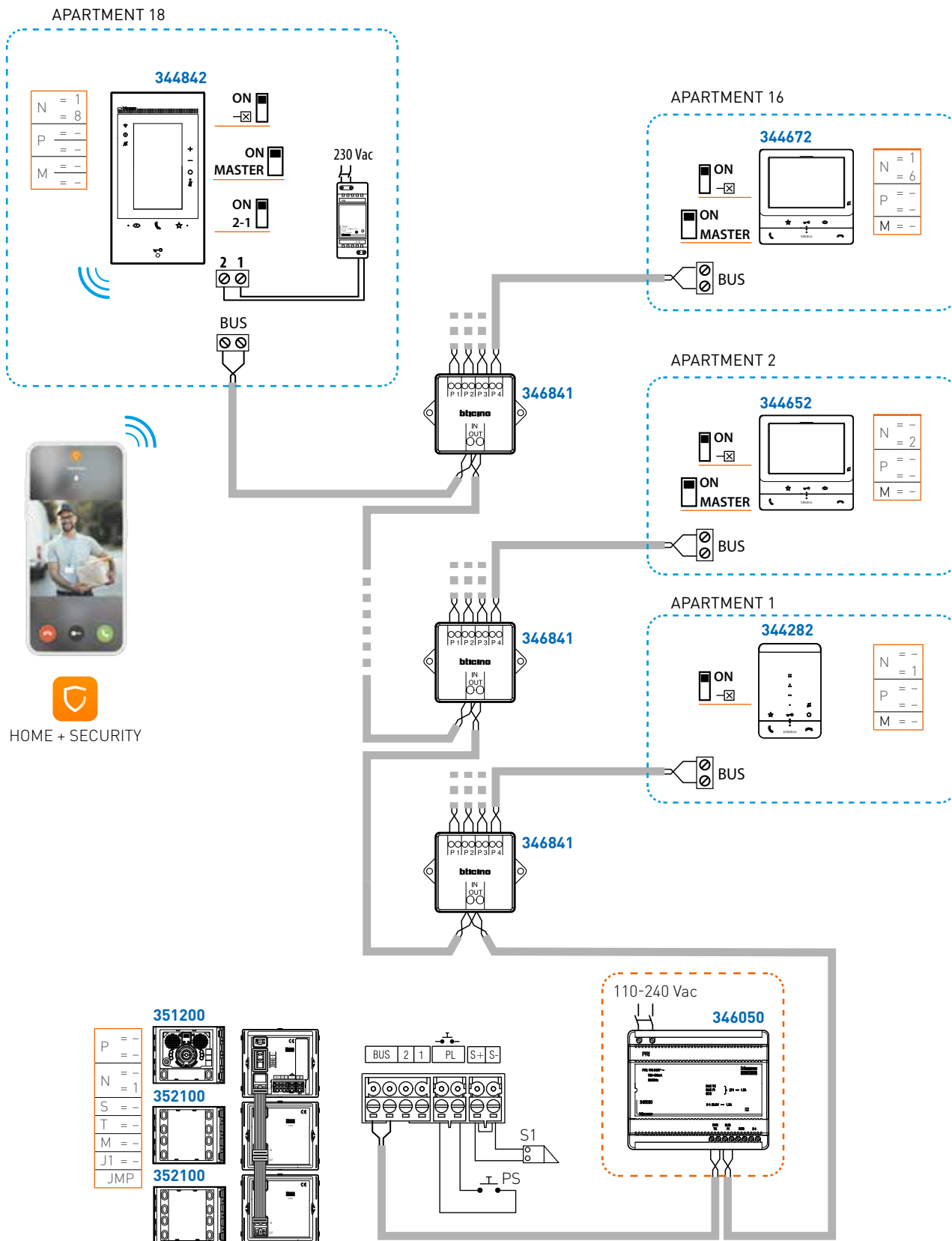

- Max. 3 internal units for each dwelling;
- Max. 200 m between the entrance panel and the last internal unit with cable 336904 / 336905;
- Max. 1 CLASSE 300EOS with Netatmo / Classe 100X video internal unit connected for each local LAN;
- A domestic Wi-Fi with internet access is needed for the connection between the CLASSE 300EOS with Netatmo / Classe 100X connected video internal unit and the smartphone;
- In multi-family installations, the connected CLASSE 300EOS with Netatmo video internal unit must be powered locally;
- CLASSE 300EOS internal unit must be installed ONLY in systems made with BTicino 2 wires technology.

# Example 4 - The apartment block

**MULTI-FAMILY SYSTEM CONSISTING OF SEVERAL BUILDINGS, A COMMON APARTMENT BLOCK ENTRANCE PANEL AND LONG DISTANCES**

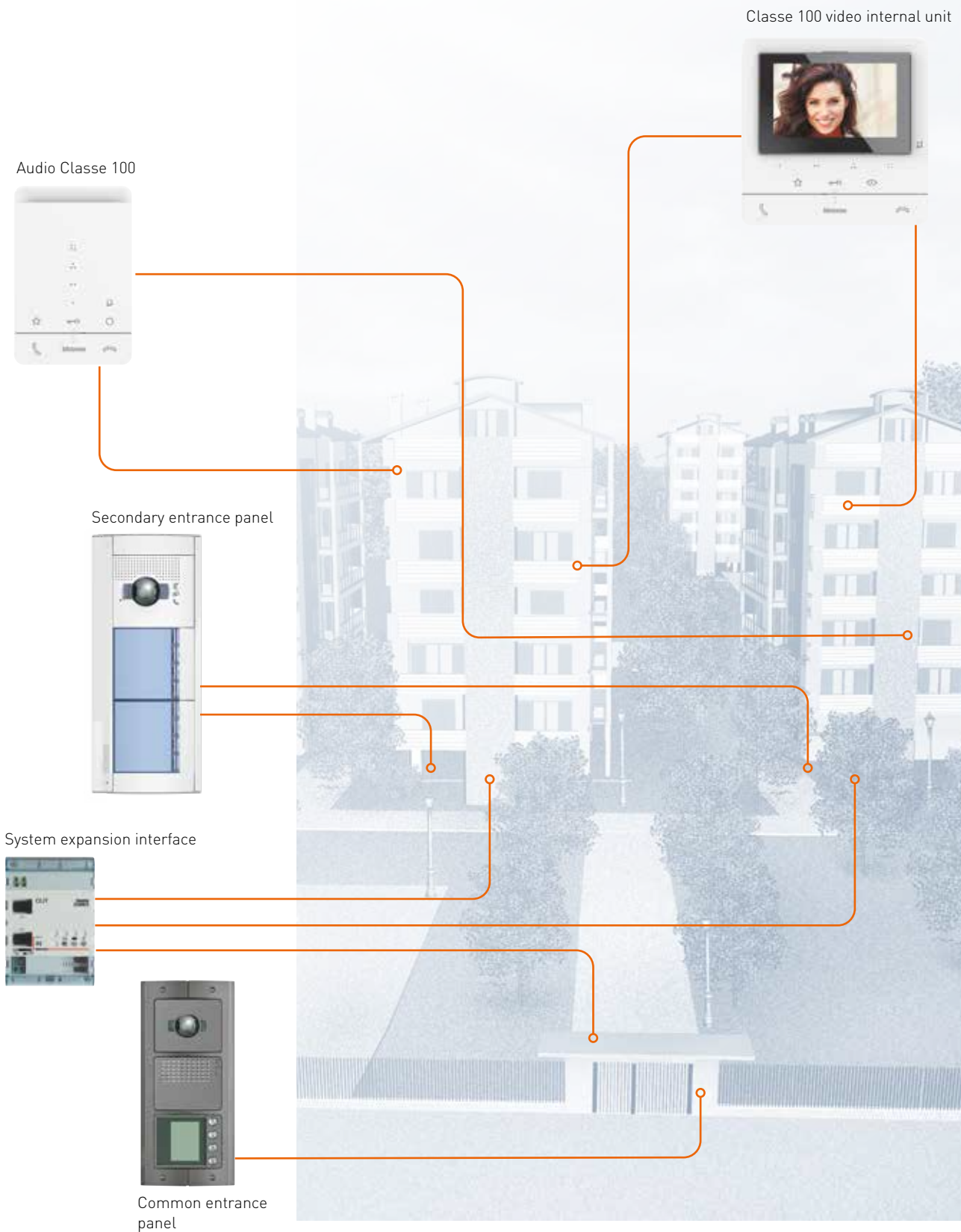

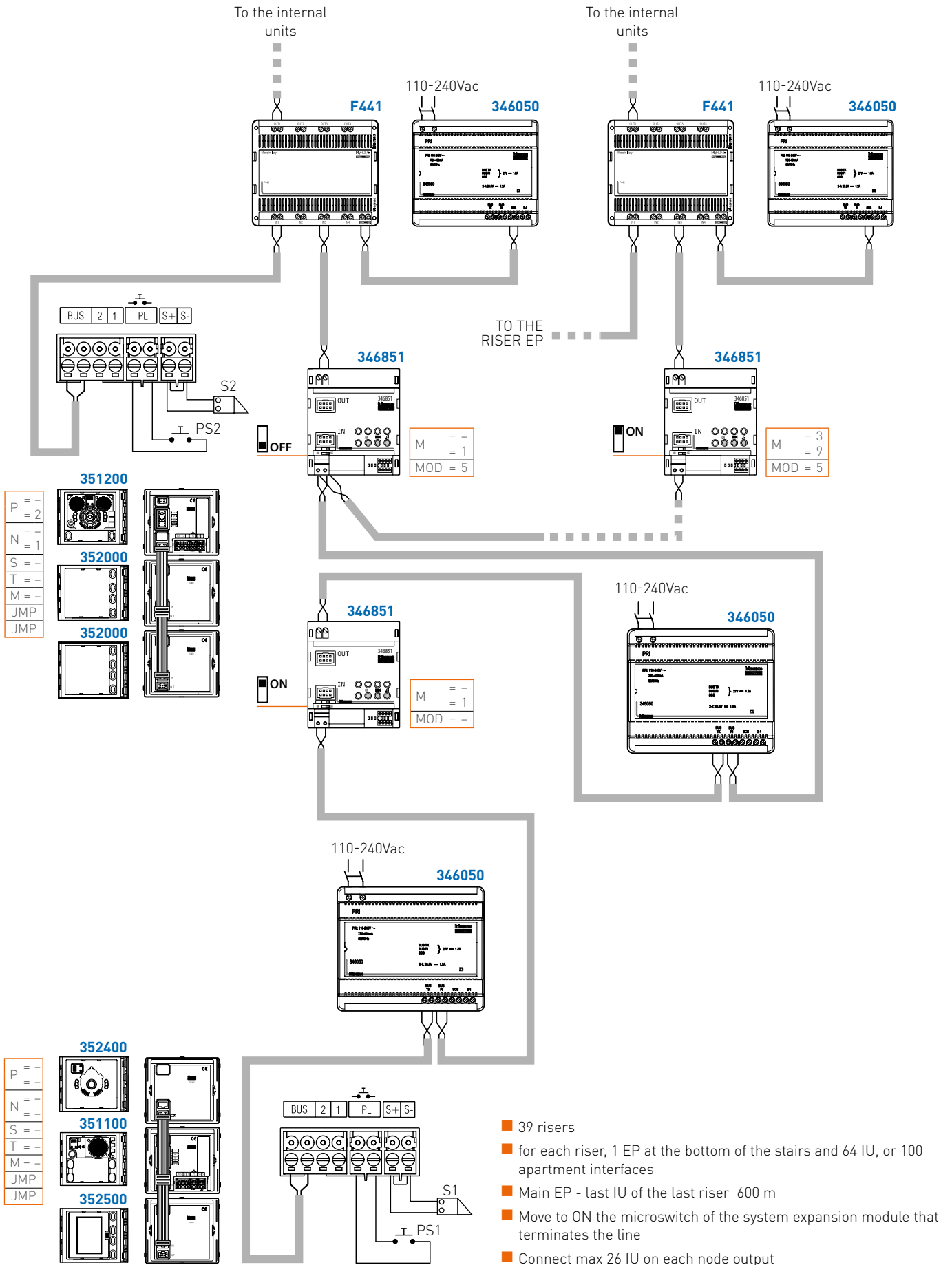

For correct sizing of the system, we recommend the use of the [YouDiagram](http://www.youdiagram.com) software - which can be downloaded free of charge from [www.bticino.com](http://www.bticino.com)

# Example 5 - the apartment

## APARTMENT WITH DEDICATED ENTRANCE PANEL AND PRIVATE CAMERAS

Classe 100 video internal unit

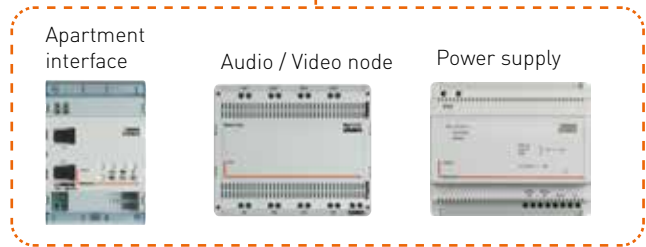
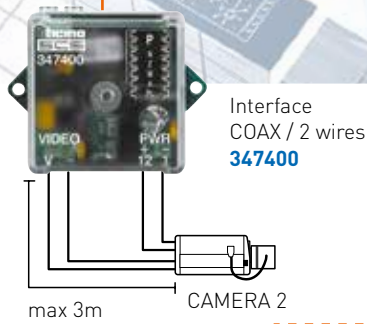
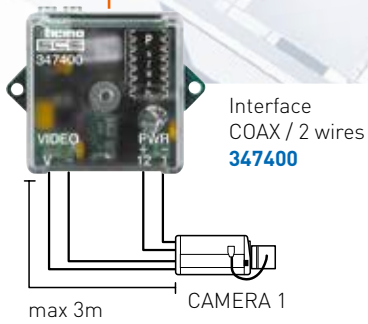



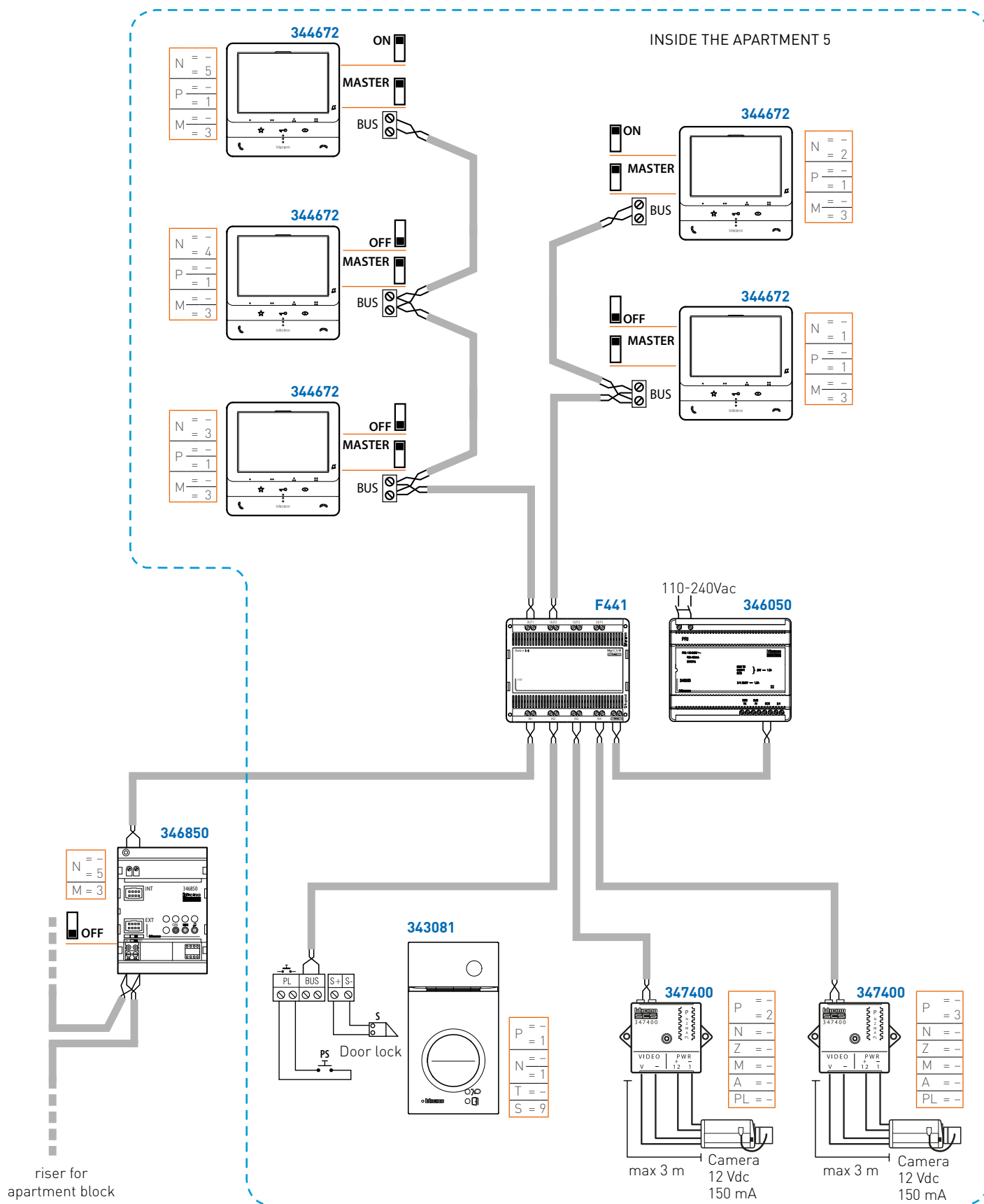

- Max 5 internal units, 1 apartment EP and 2 apartment cameras
- Configure the EP and the apartment cameras starting from P=1
- The M=3 configuration of video internal units is optional (intercom request between video internal units).

# Example 6 - The small house block

**MULTI-FAMILY SYSTEM WITH INDEPENDENT DWELLINGS AND AT LEAST ONE COMMON ACCESS POINT**



Apartment interface



Common Entrance Panel

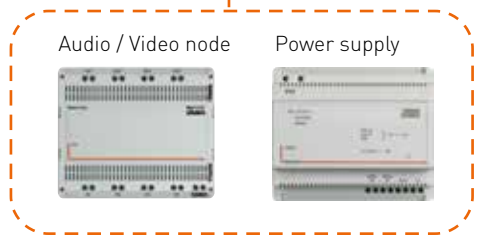

Audio / Video node

Power supply



Inside the home - see previous diagram

SMALL HOUSE 35

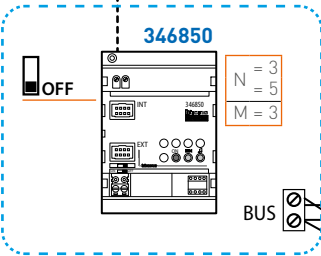

Inside the home - see previous diagram

SMALL HOUSE 99

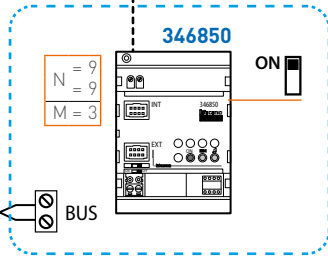

Inside the home - see previous diagram

SMALL HOUSE 1

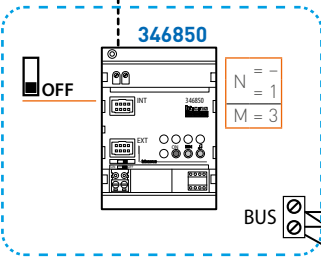

Inside the home - see previous diagram

SMALL HOUSE 26

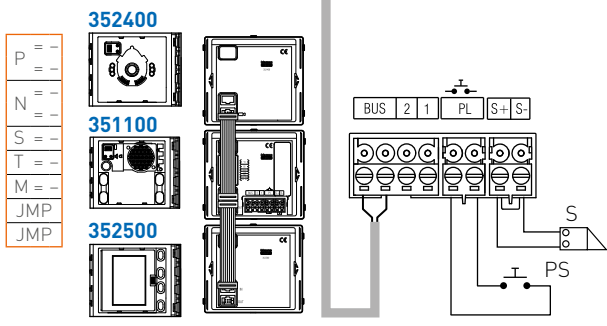
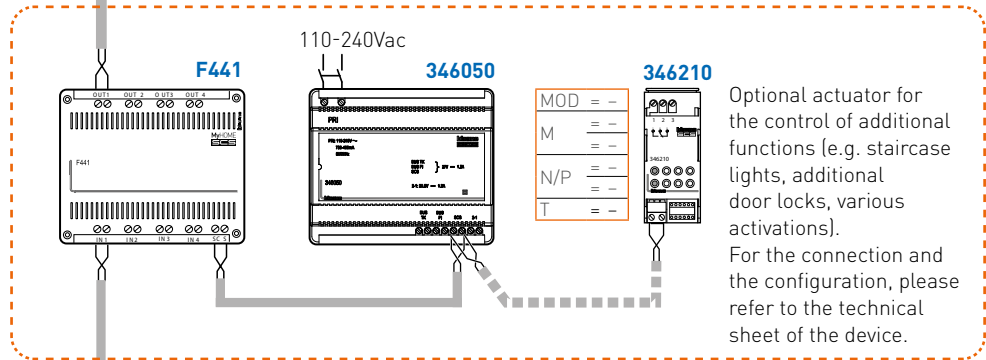
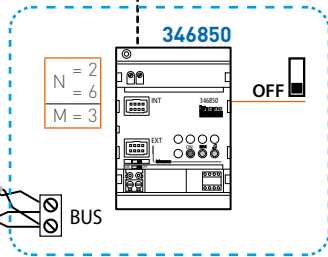

- Max 99 apartment interfaces and 1 apartment block entrance panel
- Max 50 m between Entrance Panel and audio/video node

# 1 or more main audio EP and secondary EP

ITEM	DESCRIPTION
351000	SFERA basic speaker module
352000	SFERA pushbutton module
344292	CLASSE 100A16M audio internal unit
344282	CLASSE 100A16E internal unit
344232	SPRINT L2 audio internal unit
346040	Audio power supply
346210	Actuator
PEP	SFERA (main) entrance panel
PES	SFERA (secondary) entrance panel
PS1-PS2-PS3	Door lock release pushbutton
S1-S2-S3	Electrical door lock 18V 4A impulsive - 250 mA holding current (30 Ω max)

**⚠ CAUTION**

Configure and connect the Jumpers with the system NOT POWERED. Also, every time that the configuration is changed, it will be necessary to disconnect the power supply and then reconnect it after approximately 1 minute.

**A** Optional actuator for the control of additional functions (e.g. staircase lights, additional door locks, various activations). For the connection and the configuration, please refer to the technical sheet of the device.

**B** For the installation of Internal Units other than those indicated in the diagrams, refer to the "INTERNAL UNITS VARIANTS" section

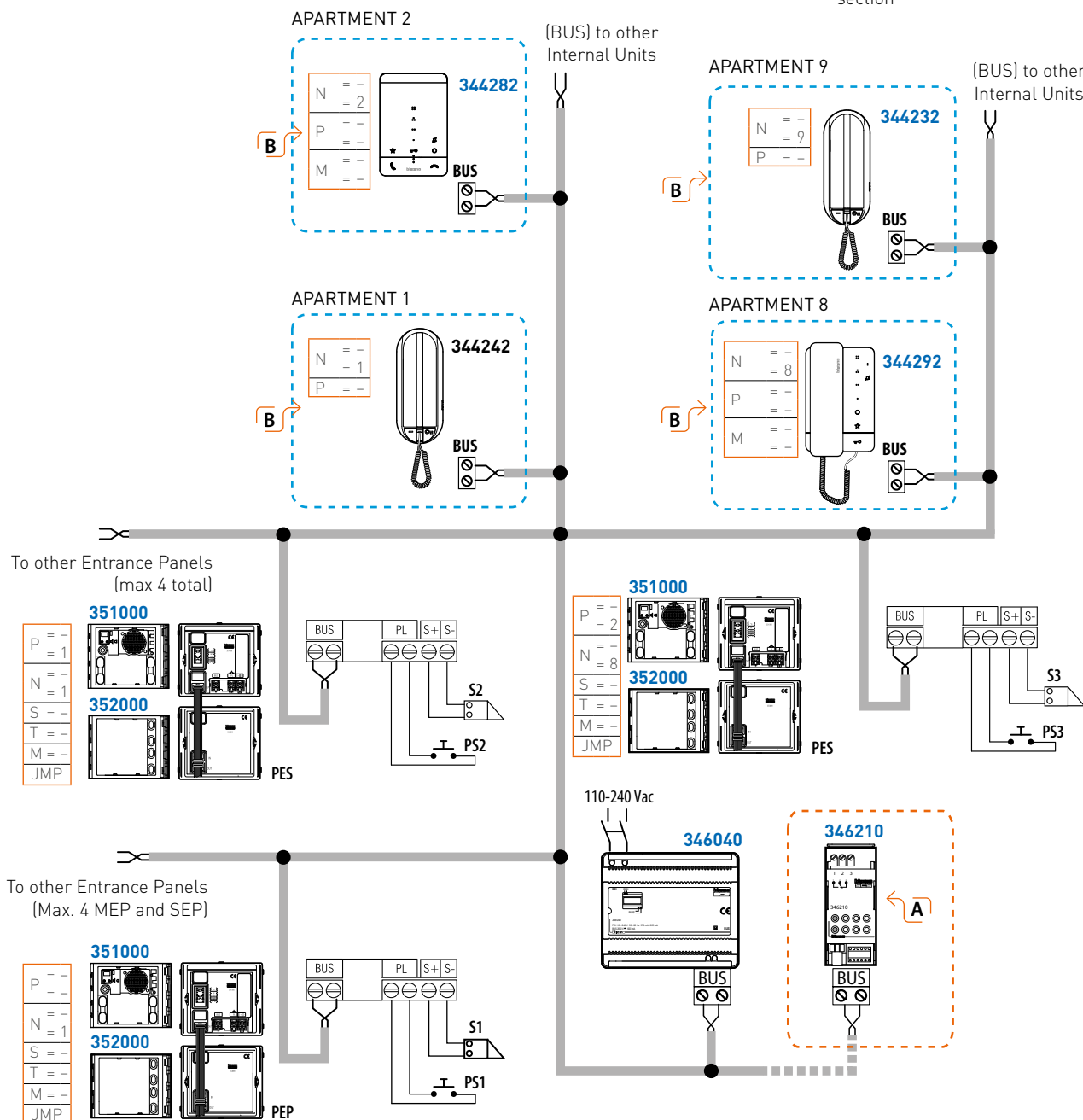

# 1 or more audio Entrance Panels

ITEM	DESCRIPTION
351100	SFERA speaker module
352000	SFERA pushbutton module
S1	Electrical door lock 18 V 4 A impulsive - 250 mA holding current (30 Ohm max)
PEP	Main entrance panel
344292	CLASSE 100A16M audio internal unit
344282	CLASSE 100A16E internal unit
344232	SPRINT L2 audio internal unit
346050	Power supply
346210	Actuator
PS1	Door lock release pushbutton

**⚠ CAUTION**

Configure and connect the Jumpers with the system NOT POWERED. Also, every time that the configuration is changed, it will be necessary to disconnect the power supply and then reconnect it after approximately 1 minute

**Example of entrance panel configuration**

	P	N	T	S
PE0	-	-	1	-
PE1	-	1	-	-
PE2	-	2	-	-
---	-	-	1	-
PE8	-	8	-	-

**N** = first apartment that the EP can call  
For the configuration of T, S and M, see the technical sheets of the single devices.

**A** Optional actuator for the control of additional functions (e.g. staircase lights, additional door locks, various activations).  
For the connection and the configuration, please refer to the technical sheet of the device.

**B** For the realisation of the Entrance Panel, it is possible to use SFERA pushbutton panels, the universal speaker module, or digital call modules.

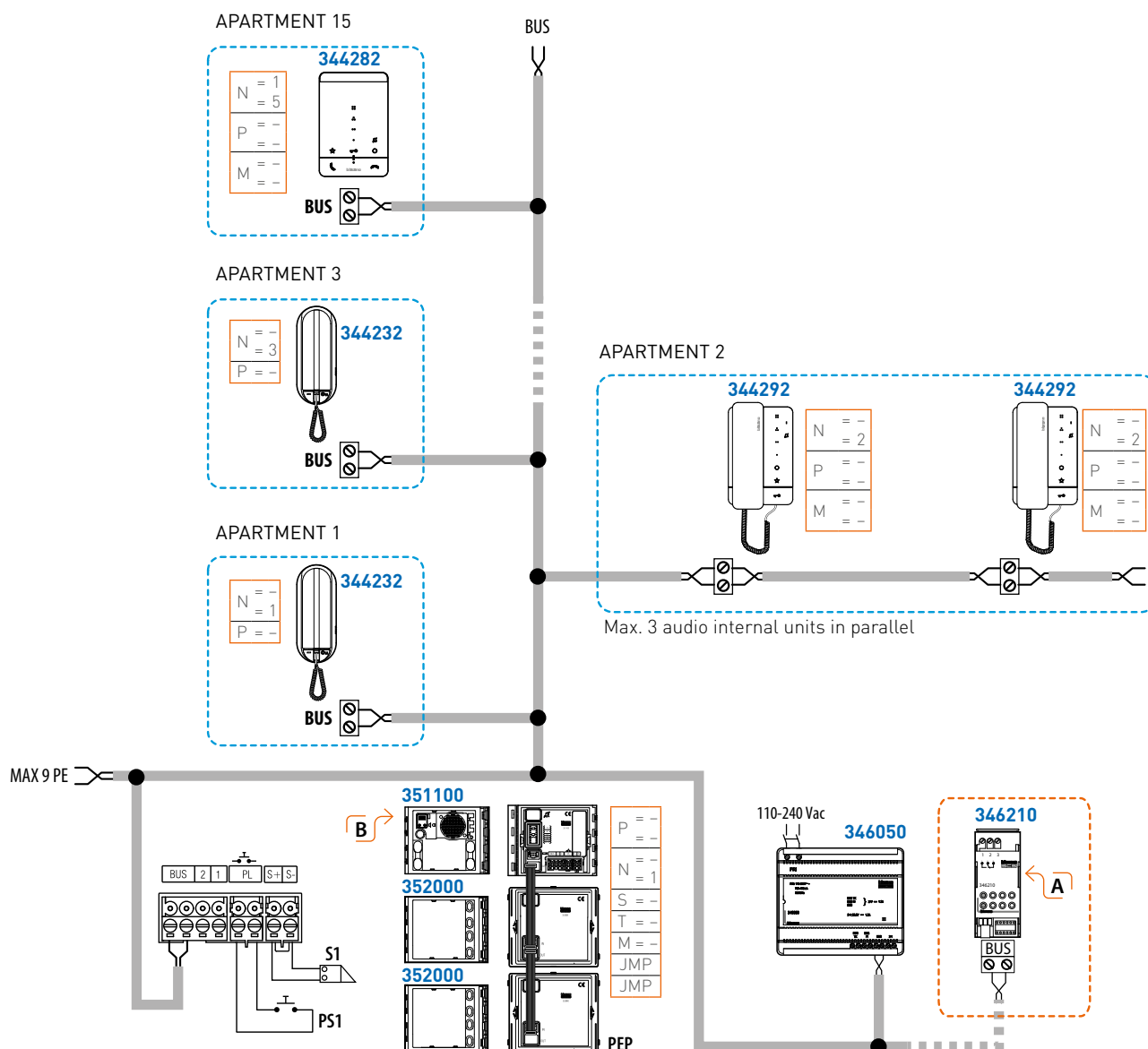

# One-family system with 1 or more audio Entrance Panels and 5 intercommunicating Internal Units

ITEM	DESCRIPTION
343071	Linea 3000 audio entrance panel
S	Electrical door lock 18 V 4 A impulsive - 250 mA holding current (30 Ohm max)
344292	CLASSE 100A16M audio internal unit
346040	Power supply
PS	Door lock release pushbutton

### ⚠ CAUTION

- Configure and connect the Jumpers with the system NOT POWERED. Also, every time that the configuration is changed, it will be necessary to disconnect the power supply and then reconnect it after approximately 1 minute.
- The intercom function is also operational without connection of the Entrance panel.

- A** For the realisation of the Entrance Panel, it is possible to use SFERA, LINEA 3000 or LINEA 2000 pushbutton panels.
- B** S=9 enables the simultaneous call of all IU

**Example of entrance panel configuration**

	P	N	T	S		
PE0	-	-	1	-	9	
PE1	-	1	-	1	-	9
PE2	-	2	-	1	-	9
---	-	-	-	1	-	9
PE8	-	8	-	1	-	9

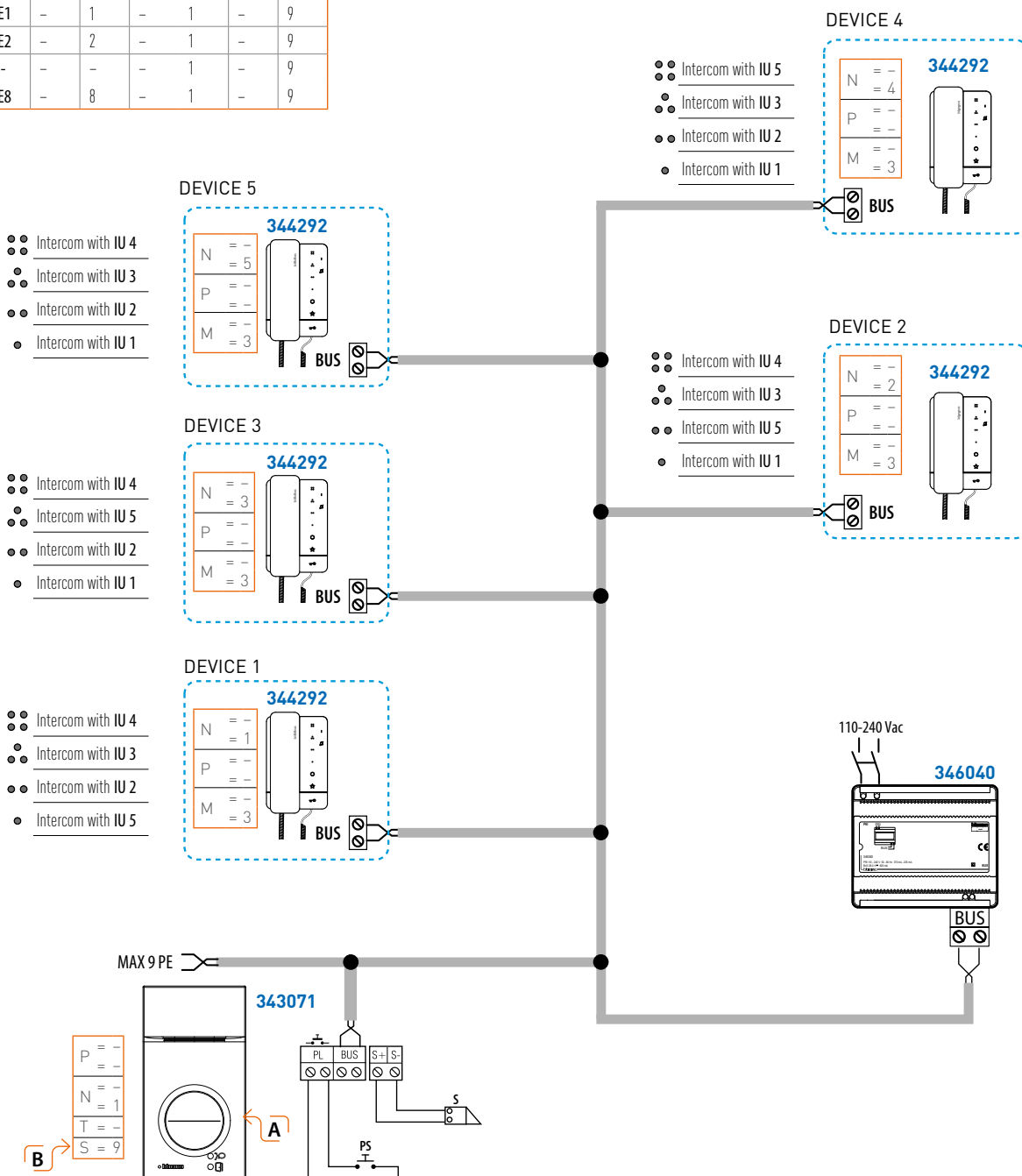

# Two-family system, 1 EP and 3 IU for each apartment with “Internal intercom and intercom among apartments” function

ITEM	DESCRIPTION
351100	SFERA speaker module
344282	CLASSE 100A16E internal unit
346040	Power supply
PEP	Main Entrance Panel
PS	Door lock release pushbutton
S	Electrical door lock 18 V 4 A impulsive - 250 mA holding current (30 Ohm max)

### ⚠ CAUTION

- Configure and connect the Jumpers with the system NOT POWERED. Also, every time that the configuration is changed, it will be necessary to disconnect the power supply and then reconnect it after approximately 1 minute.
- The intercom function is also operational without connection of the Entrance panel.
- The intercom between units makes it possible to call units of the same apartment or of other apartments.

**A** Optional actuator for the control of additional functions (e.g. staircase lights, additional door locks, various activations).  
For the connection and the configuration, please refer to the technical sheet of the device.

**B** For the installation of Internal Units other than those indicated in the diagrams, refer to the “INTERNAL UNITS VARIANTS” section.

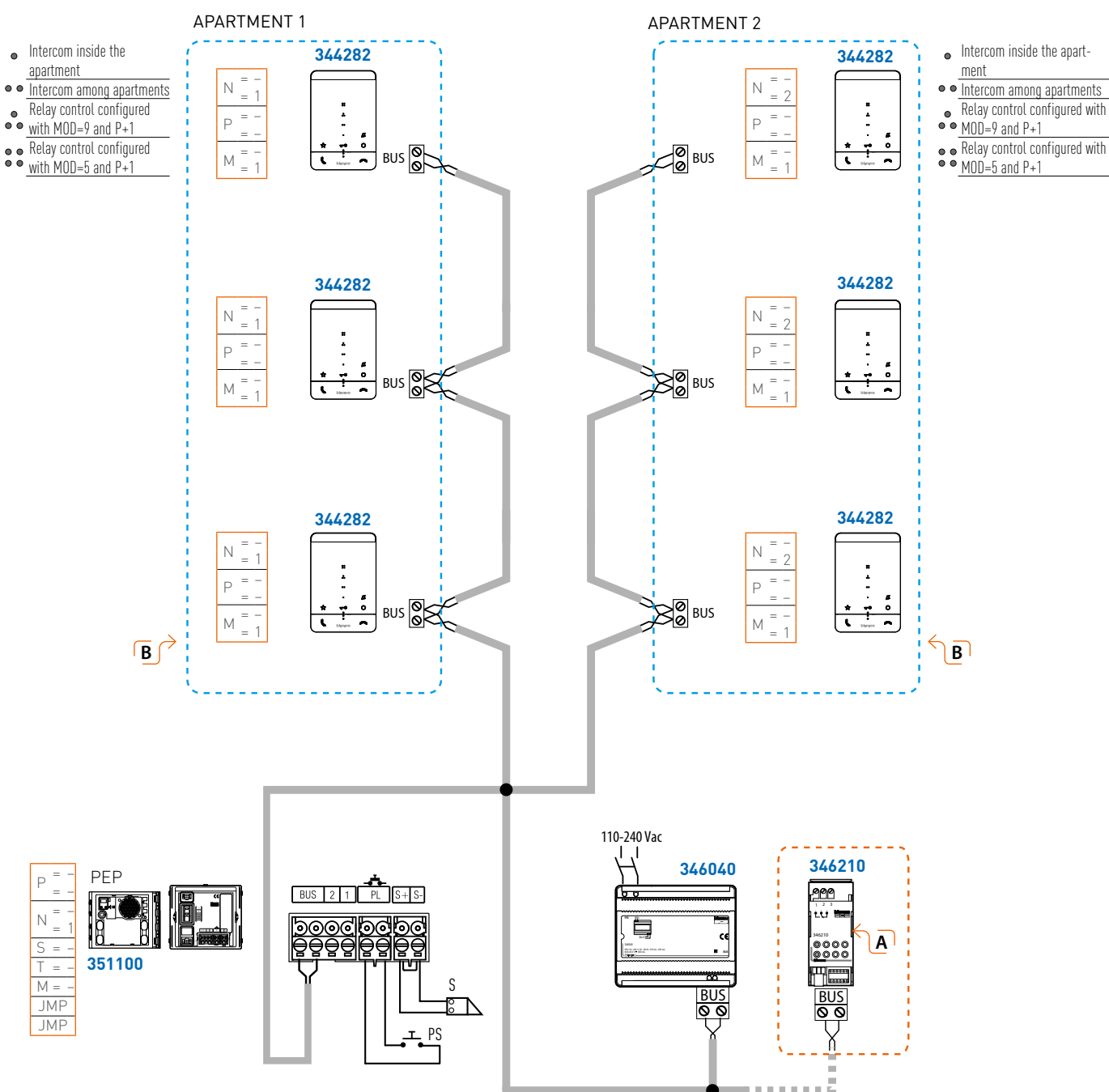

# 1 or more main audio Entrance Panels with universal speaker unit

In systems with more than 8 pushbuttons, in addition to module 346991 it is necessary to allow for a 346992 module every 8 pushbuttons; for the connection, it will be necessary to use the 2-connector multiple cable supplied with item 346992 itself. The following diagram shows the internal wiring between speaker module 346991, one or more 346992 expansion modules, and the pushbuttons in systems with more than 8 internal units.

ITEM	DESCRIPTION
336842	Transformer
344292	CLASSE 100A16M audio internal unit
346230	Door lock actuator
346991	Universal speaker module
346992	Pushbutton expansion
PEP	Main Entrance Panel
PS1	Door lock release pushbutton
S1	Electric door lock

### CAUTION

Configure and connect the Jumpers with the system NOT POWERED. Also, every time that the configuration is changed, it will be necessary to disconnect the power supply and then reconnect it after approximately 1 minute.

**Example of entrance panel configuration**

	P	N	T	S
PE0	-	-	1	-
PE1	-	1	1	-
PE2	-	2	1	-
---	-	-	1	-

N = first apartment that the EP can call

- A** The use of the actuator is necessary if the door lock opening function is required (see the actuator technical sheet).
- B** For the installation of Internal Units other than those indicated in the diagrams, refer to the "INTERNAL UNITS VARIANTS" section.
- C** The common of the pushbuttons must be connected to the 346991 or 346992 module to which the pushbuttons themselves are connected.

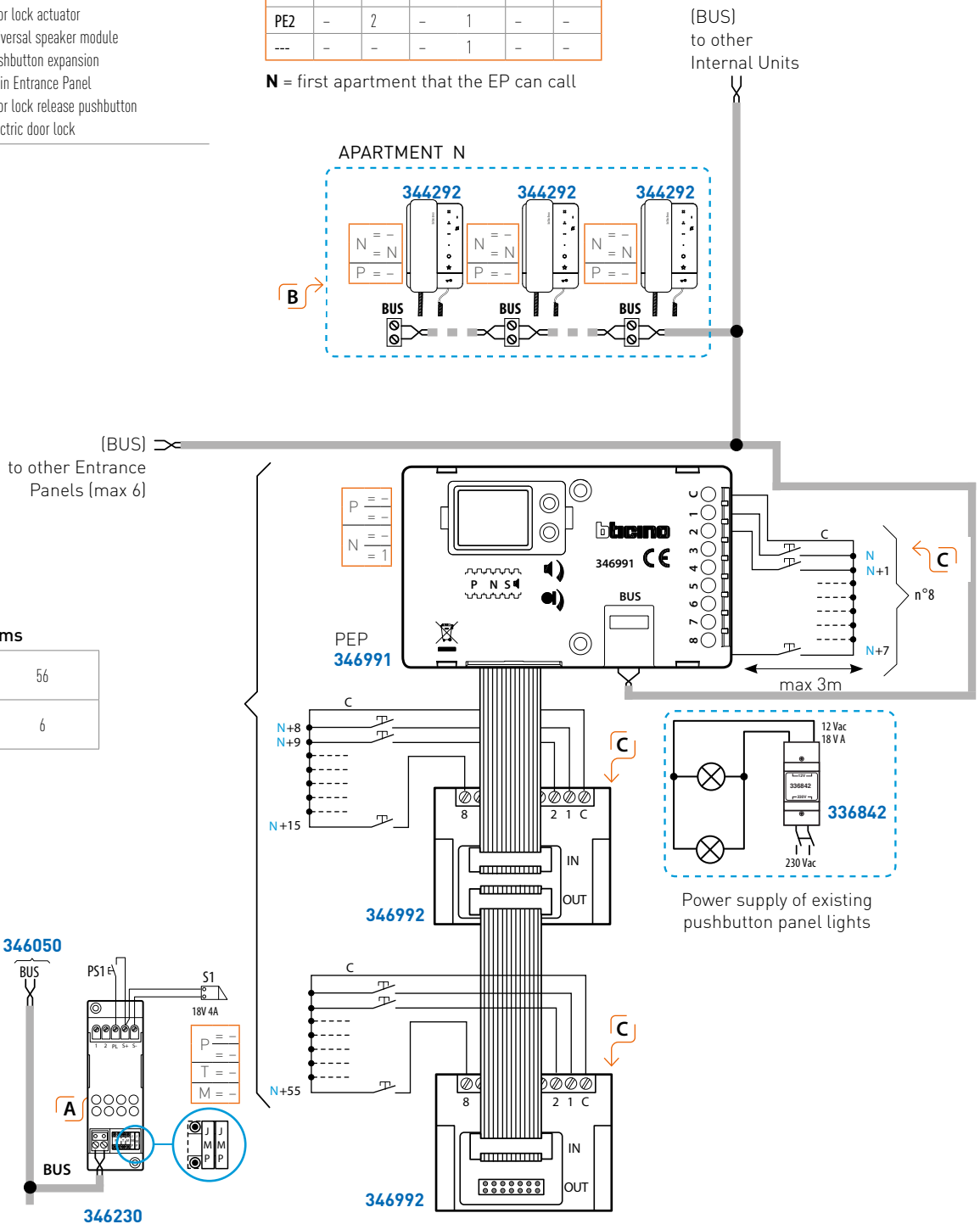

### Possible systems

Max. No. of call pushbuttons	56
Max. No. of expansions	6

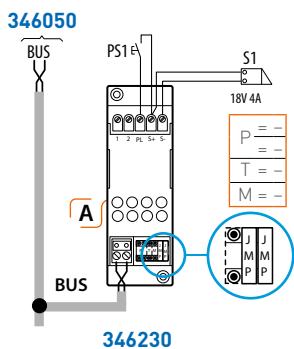



# Multifamily system with 1 or more main EP and 5 intercommunicating audio internal units

ITEM	DESCRIPTION
351000	SFERA speaker module
352100	SFERA pushbutton module
344292	CLASSE 100A16M audio internal unit
346050	Power supply
346210	Actuator
PEP	Main Entrance Panel
PS1	Door lock release pushbutton
S1	Electrical door lock 18 V 4 A impulsive - 250 mA holding current (30 Ohm max)

### CAUTION

- Configure and connect the Jumpers with the system NOT POWERED. Also, every time that the configuration is changed, it will be necessary to disconnect the power supply and then reconnect it after approximately 1 minute.
- The intercom function is also operational without connection of the Entrance panel.
- The intercom among apartments can be used with Classe 100A16M / Classe 100A16E internal units configured from N=1 to N=5.

- A** Optional actuator for the control of additional functions (e.g. staircase lights, additional door locks, various activations). For the connection and the configuration, please refer to the technical sheet of the device.
- B** For the realisation of the Entrance Panel, it is possible to use any SFERA pushbutton panels (not with digital call). For further information, see the "ENTRANCE PANEL VARIANTS" section.
- C** For the installation of Internal Units other than those indicated in the diagrams, refer to the "INTERNAL UNITS VARIANTS" section.

### Example of entrance panel configuration

	P	N	T	S
PE0	-	-	1	-
PE1	-	1	-	-
PE2	-	2	-	-
---	-	-	1	-
PE8	-	8	-	-

N = first apartment that the EP can call

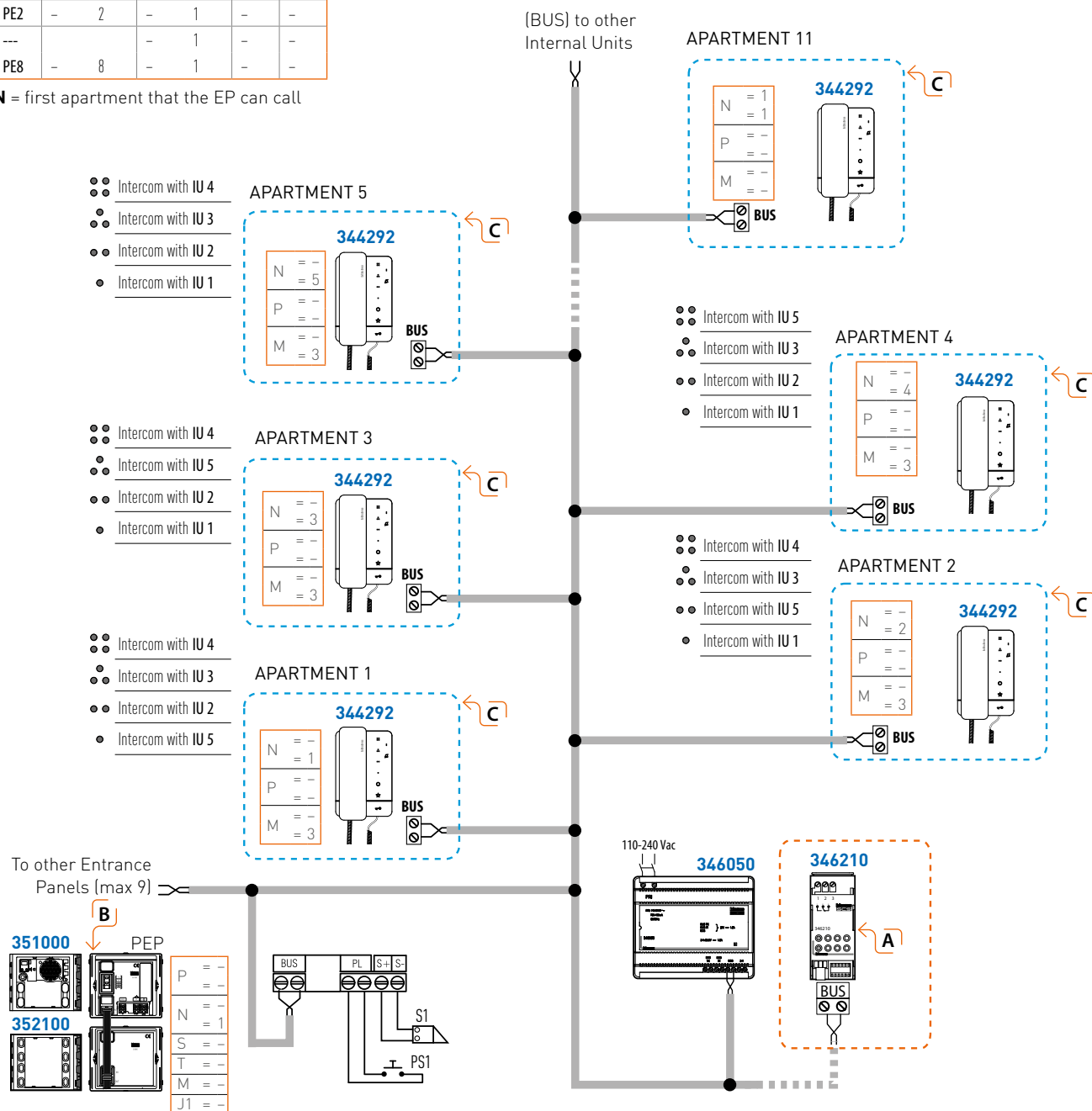

# Multifamily system with several main audio EP and call to the guard station

**Note:** with this type of installation, the audio is not isolated, and only one communication at the time is possible

ITEM	DESCRIPTION
351000	SFERA basic speaker module
352000	SFERA pushbutton module
344232	SPRINT L2 audio internal unit
346310	Guard station
346020	Additional power supply
346050	Power supply
PEP	Main Entrance Panel
PES	Secondary Entrance Panel
PS1-PS2-PS3	Door lock release pushbutton
S1-S2-S3	Electrical door lock 18V 4A impulsive - 250 mA holding current (30 Ω max)

**CAUTION**

Configure and connect the Jumpers with the system NOT POWERED. Also, every time that the configuration is changed, it will be necessary to disconnect the power supply and then reconnect it after approximately 1 minute.

**A** For the installation of Internal Units other than those indicated in the diagrams, refer to the "INTERNAL UNITS VARIANTS" section.

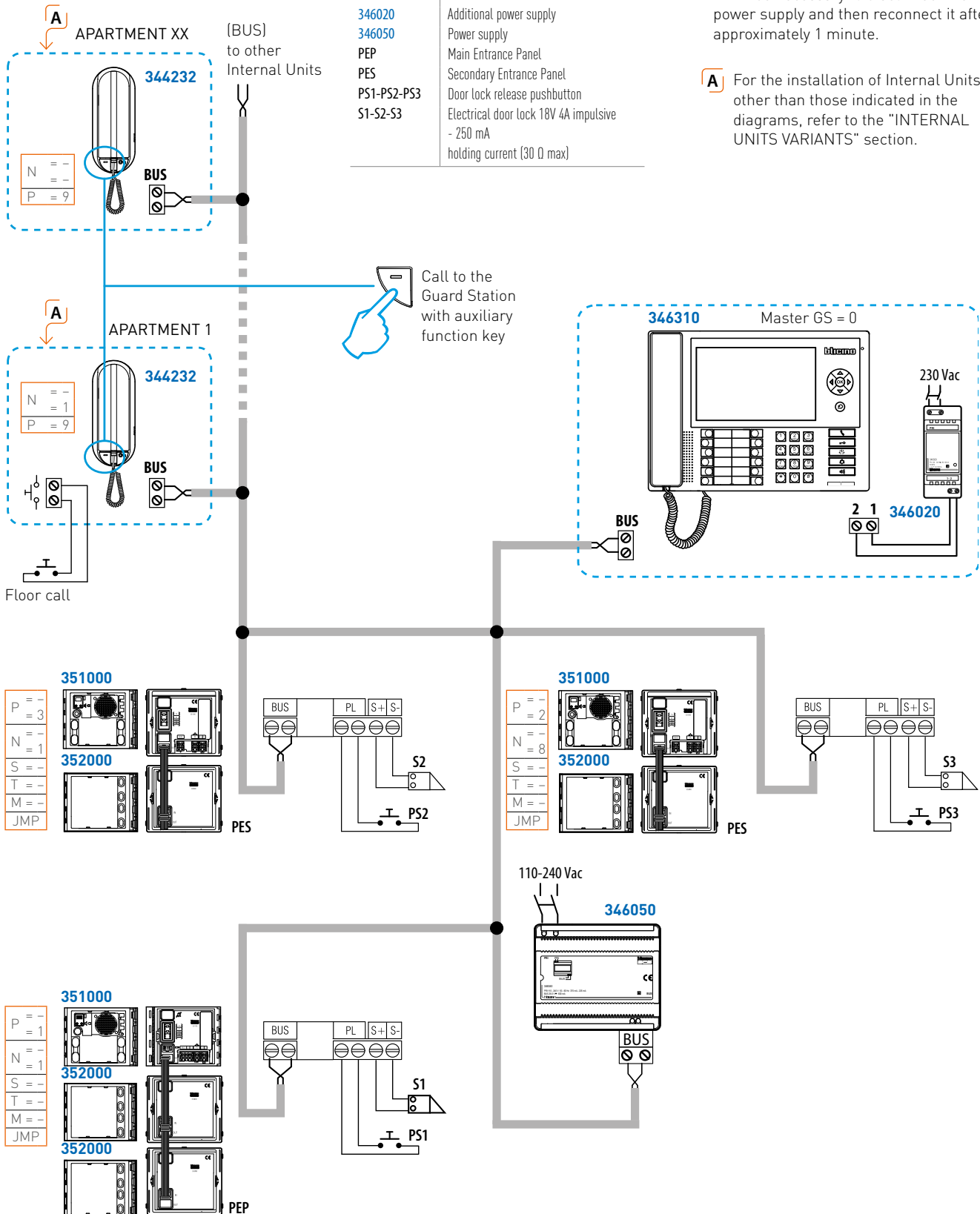

# Video system with 1 EP and star-connected riser using non-twisted cables or pre-existing cables

ITEM	DESCRIPTION
351200	SFERA audio/video speaker module
352100	SFERA pushbutton module
344652	CLASSE 100V16B handsfree video internal unit
346050	Power supply
346210	Actuator
346870	Line amplifier
PEP	Main Entrance Panel
PS	Door lock release pushbutton
S	Electrical door lock 18 V 4 A impulsive - 250 mA holding current (30 Ohm max)

**⚠ CAUTION**

Configure and connect the Jumpers with the system NOT POWERED. Also, every time that the configuration is changed, it will be necessary to disconnect the power supply and then reconnect it after approximately 1 minute.

- A** Optional actuator for the control of additional functions (e.g. staircase lights, additional door locks, various activations). For the connection and the configuration, please refer to the technical sheet of the device.
- B** For the realisation of the Entrance Panel, it is possible to use any SFERA pushbutton panels with pushbutton call or digital call. For further information, see the "ENTRANCE PANEL VARIANTS" section.
- C** Move to ON the microswitch on the back of the audio or video internal unit that terminates the line.
- D** On the riser line, after item 346870 it will be possible to install up to 18 IU max (audio and video internal units).
- E** To wire the system, use existing cables or cables with section  $\geq 0,28 \text{ mm}^2$
- F** Item 346870 must only be used if the distance between the EP and the last IU exceeds 50 m, and must be installed approximately 50 metres from the Entrance Panel
- G** For the installation of Internal Units other than those indicated in the diagrams, refer to the "INTERNAL UNITS VARIANTS" section.

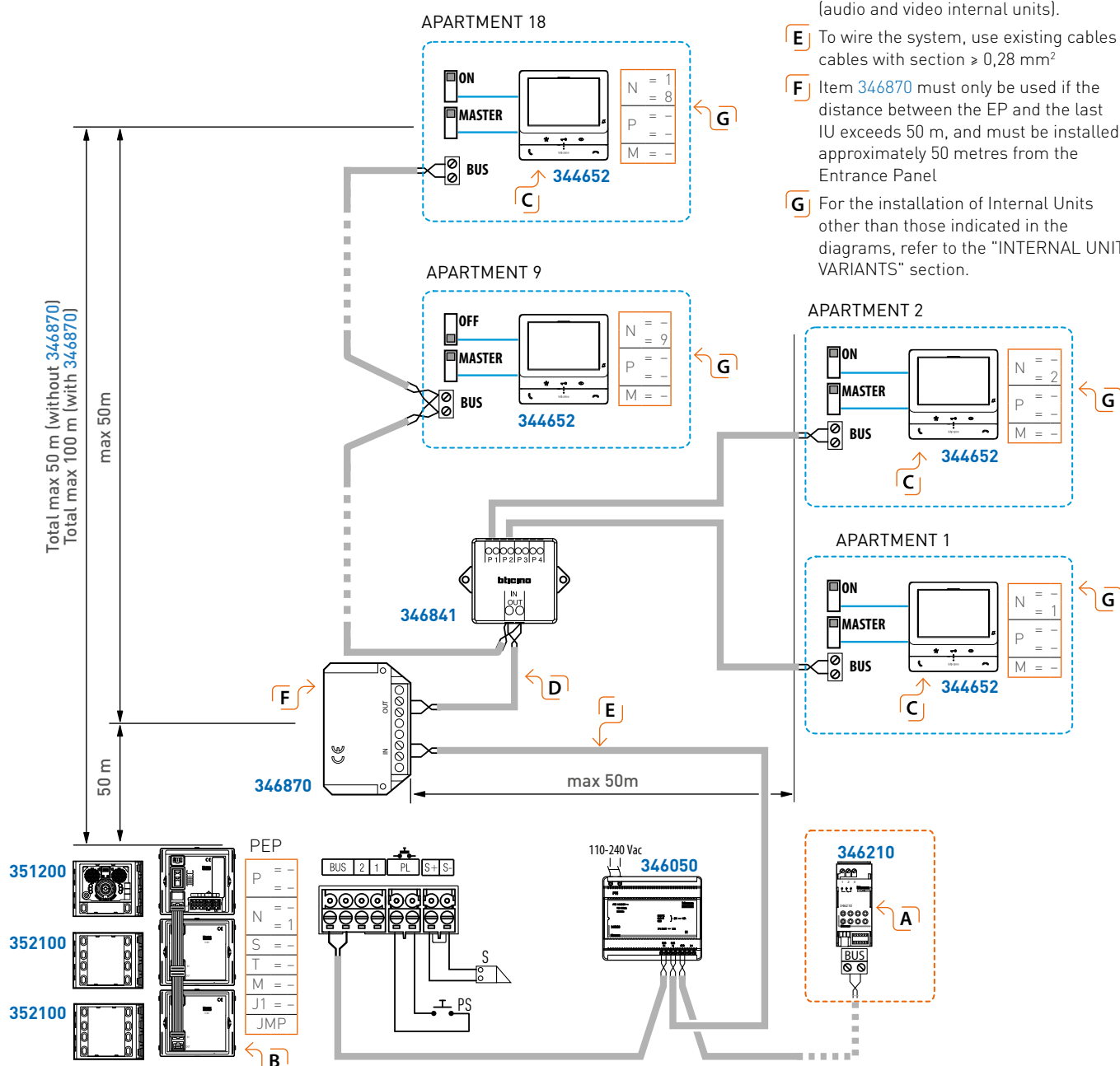

# Multifamily video system with universal speaker module 346991 and associated separate camera

ITEM	DESCRIPTION
346050	Power supply
346991	Universal speaker module
346992	Key expansion module
347400	Coax / 2 wires interface

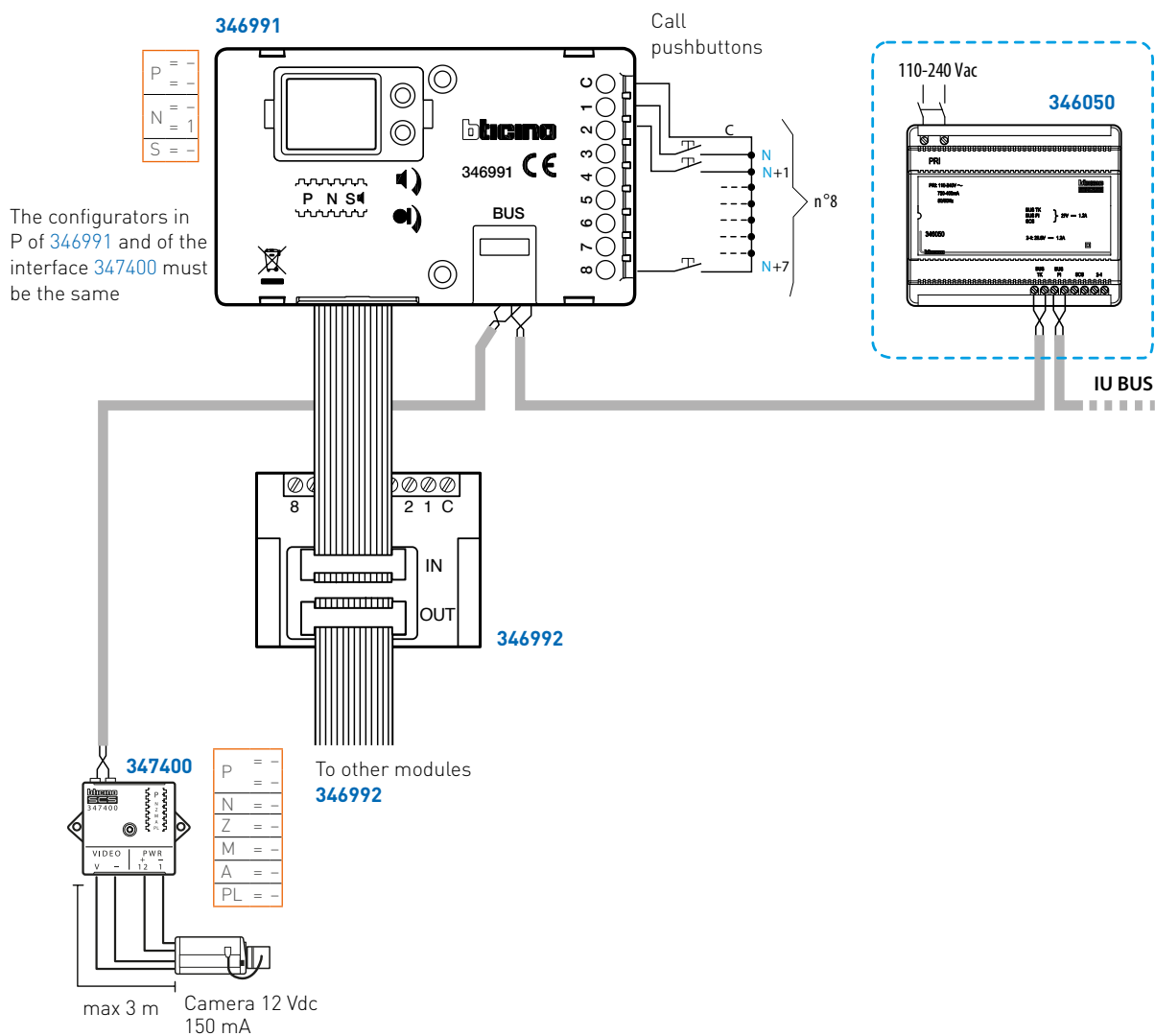

# 1 main video Entrance Panel and 1 riser with floor shunt wiring

ITEM	DESCRIPTION
351100	SFERA speaker module
352100	SFERA pushbutton module
352400	N/D camera module
344652	CLASSE 100V16B handsfree video internal unit
344282	CLASSE 100A16E handsfree audio internal unit
346050	Power supply
346210	Actuator
346841	Floor shunt
PEP	Main Entrance Panel
PS	Door lock release pushbutton
S	Electrical door lock 18 V 4 A impulsive 250 mA holding current (30 Ohm max)

## CONNECTION COMBINATIONS

1 video EP, max. 2 risers on IU BUS 346050  
 2 video EP, max. 1 riser on IU BUS 346050

### ⚠ CAUTION

■ Configure and connect the Jumpers with the system NOT POWERED. Also, every time that the configuration is changed, it will be necessary to disconnect the power supply and then reconnect it after approximately 1 minute.

- A** Optional actuator for the control of additional functions (e.g. staircase lights, additional door locks, various activations). For the connection and the configuration, please refer to the technical sheet of the device.
- B** For the realisation of the Entrance Panel, it is possible to use any SFERA pushbutton panels, with pushbutton call or digital call, both as main and secondary EP. For further information, see the "ENTRANCE PANEL VARIANTS" section.
- C** Move to ON the microswitch on the back of the audio or video internal unit that terminates the line.
- D** For the installation of Internal Units other than those indicated in the diagrams, refer to the "INTERNAL UNITS VARIANTS" section.

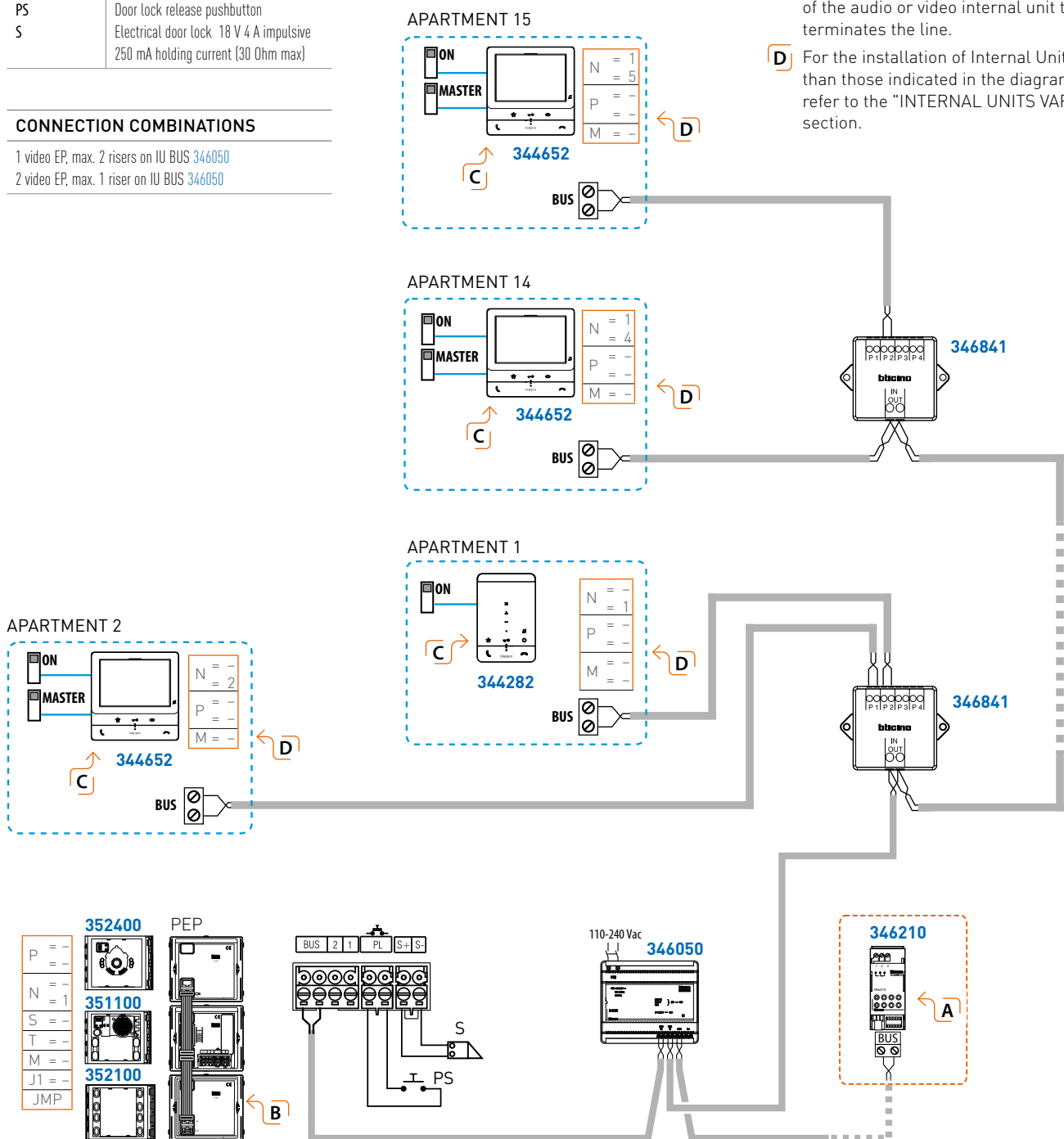

# 1 main video Entrance Panel and 2 risers with floor shunt wiring

ITEM	DESCRIPTION
351300	SFERA WIDE ANGLE A/V module
352500	SFERA Display Module
344292	CLASSE 100A16M internal unit
344652	CLASSE 100V16B handsfree video internal unit
346050	Power supply
346210	Actuator
3499	Line terminator
PEP	Main Entrance Panel
PS	Door lock release pushbutton
S	Electrical door lock 18 V 4 A impulsive - 250 mA holding current (30 Ohm max)

### CAUTION

Configure and connect the Jumpers with the system NOT POWERED. Also, every time that the configuration is changed, it will be necessary to disconnect the power supply and then reconnect it after approximately 1 minute.

### CONNECTION COMBINATIONS

- 1 video EP, max. 2 risers on IU BUS 346050
- 2 video EP, max. 1 riser on IU BUS 346050

- A** Optional actuator for the control of additional functions (e.g. staircase lights, additional door locks, various activations). For the connection and the configuration, please refer to the technical sheet of the device.
- B** For the realisation of the Entrance Panel, it is possible to use any SFERA pushbutton panels with pushbutton call or digital call. For further information, see the "ENTRANCE PANEL VARIANTS" section.
- C** Move to ON the microswitch on the back of the audio or video internal unit that terminates the line.
- D** For the installation of Internal Units other than those indicated in the diagrams, refer to the "INTERNAL UNITS VARIANTS" section.

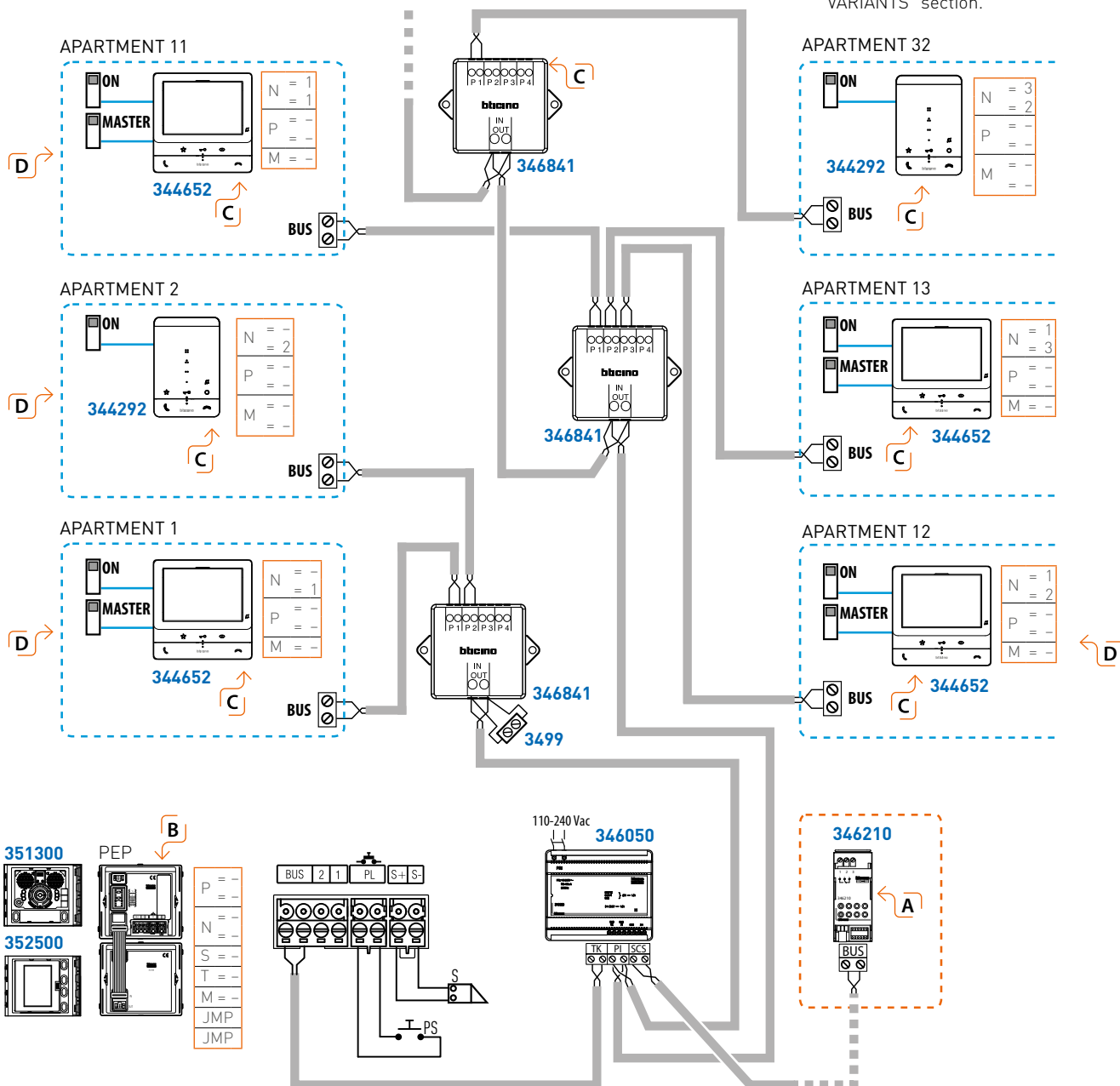

# 2 main video Entrance Panels and 1 riser with in-out wiring

ITEM	DESCRIPTION
351200	SFERA A/V module
352100	SFERA pushbutton module
344652	CLASSE 100V16B handsfree video internal unit
346050	Power supply
346210	Actuator
PEP1 - PEP2	Main Entrance Panel
PS1 - PS2	Door lock release pushbutton
S1 - S2	Electrical door lock 18 V 4 A impulsive 250 mA holding current (30 Ohm max)

### CONNECTION COMBINATIONS

1 video EP, max. 2 risers on IU BUS 346050  
 2 video EP, max. 1 riser on IU BUS 346050

### ⚠ CAUTION

Configure and connect the Jumpers with the system NOT POWERED. Also, every time that the configuration is changed, it will be necessary to disconnect the power supply and then reconnect it after approximately 1 minute.

**A** Optional actuator for the control of additional functions (e.g. staircase lights, additional door locks, various activations). For the connection and the configuration, please refer to the technical sheet of the device.

**B** For the realisation of the Entrance Panel, it is possible to use any SFERA pushbutton panels, with pushbutton call or digital call, both as main and secondary EP. For further information, see the "ENTRANCE PANEL VARIANTS" section.

**C** Move to ON the microswitch on the back of the audio or video internal unit that terminates the line.

**D** For the installation of Internal Units other than those indicated in the diagrams, refer to the "INTERNAL UNITS VARIANTS" section.

**E** Video internal units are installed in the apartment with MASTER-SLAVE function. Upon arrival of the call, the MASTER rings and switches on, while the SLAVE unit only rings. If the call is answered from the SLAVE, the MASTER switches off and the monitor of the SLAVE switches on.

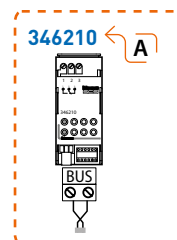
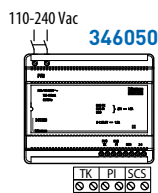
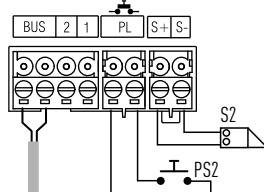
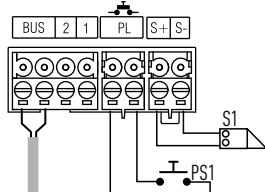
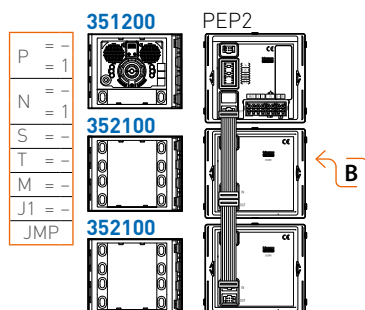
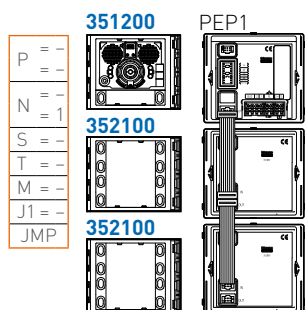
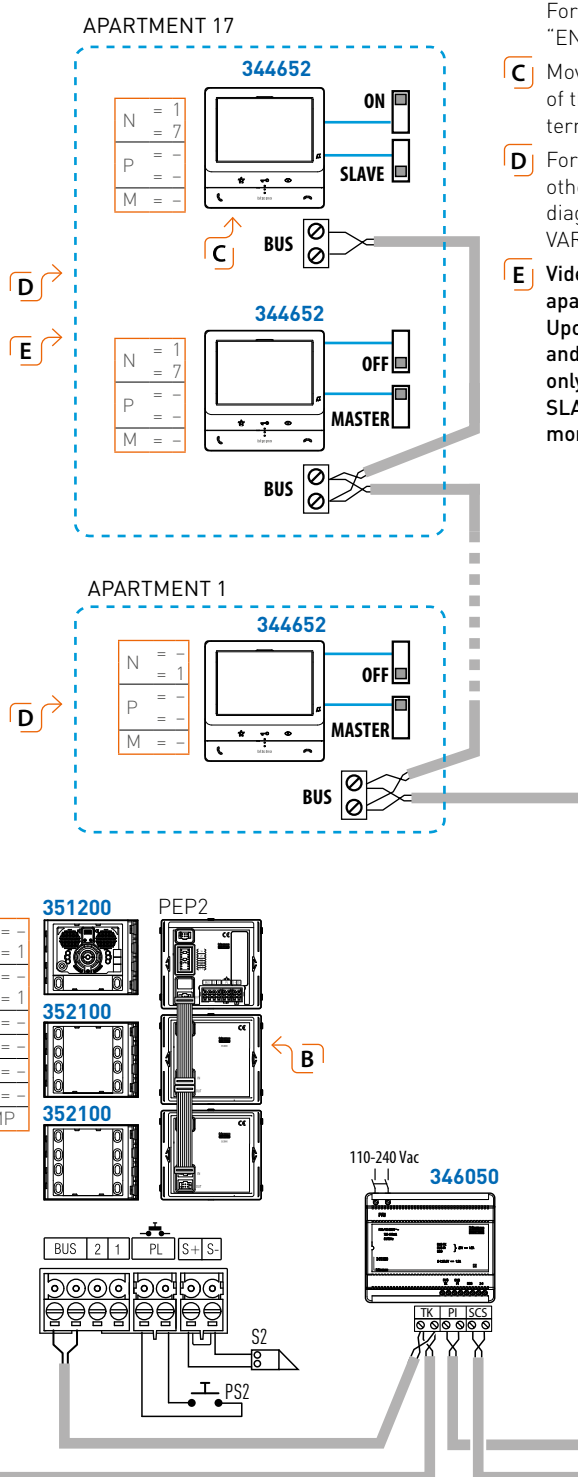

# 2 main video EP with additional power supply and star-connected riser

ITEM	DESCRIPTION
351200	SFERA A/V module
352000	SFERA pushbutton module
352500	SFERA Display Module
353000	SFERA Keypad Module
344652	CLASSE 100V16B handsfree video internal unit
346050	Power supply
346020	Additional power supply
346210	Actuator
346841	Floor shunt
PEP1 - PEP2	Main Entrance Panel
PS1 - PS2	Door lock release pushbutton
S1 - S2	Electrical door lock 18 V 4 A impulsive 250 mA holding current (30 Ohm max)

**CAUTION**

Configure and connect the Jumpers with the system NOT POWERED. Also, every time that the configuration is changed, it will be necessary to disconnect the power supply and then reconnect it after approximately 1 minute.

- A** Optional actuator for the control of additional functions (e.g. staircase lights, additional door locks, various activations). For the connection and the configuration, please refer to the technical sheet of the device.
- B** For the installation of Internal Units other than those indicated in the diagrams, refer to the "INTERNAL UNITS VARIANTS" section.
- C** Move to ON the microswitch on the back of the audio or video internal unit that terminates the line.

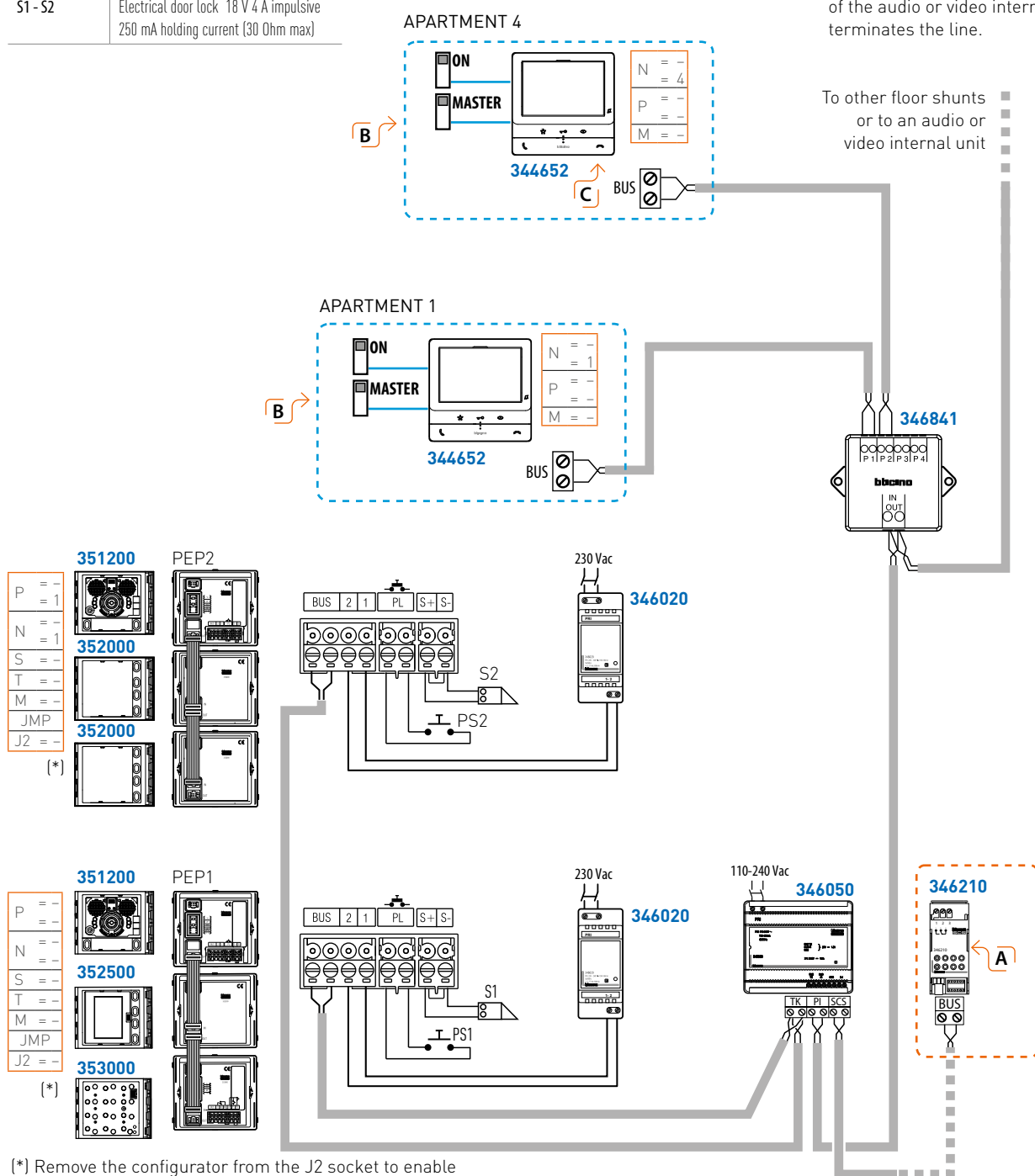

(\*) Remove the configurator from the J2 socket to enable the additional power supply to the entrance panel



# One-family system with 1 video Entrance Panel and 5 Internal Units in parallel and intercommunicating

ITEM	DESCRIPTION
351300	SFERA WIDE ANGLE A/V module
344672	CLASSE 100V16E video internal unit
346050	Power supply
346210	Actuator
PEP	Main Entrance Panel
PS	Door lock release pushbutton
S	Electrical door lock 18 V 4 A impulsive 250 mA holding current (30 Ohm max)

### ⚠ CAUTION

- Configure the IU from N = 1
- Configure and connect the Jumpers with the system NOT POWERED. Also, every time that the configuration is changed, it will be necessary to disconnect the power supply and then reconnect it after approximately 1 minute.
- The intercom function is also operational without connection of the Entrance panel.

- A** Optional actuator for the control of additional functions (e.g. staircase lights, additional door locks, various activations). For the connection and the configuration, please refer to the technical sheet of the device.
- B** For the realisation of the Entrance Panel, it is possible to use SFERA, LINEA 3000 or LINEA 2000 pushbutton panels. For further information, see the "ENTRANCE PANEL VARIANTS" section.
- C** Move to ON the microswitch of the system audio or video internal unit that terminates the line.
- D** Allow for a "9" configurator to be connected to S on the speaker module for making the general call.
- E** For the installation of Internal Units other than those indicated in the diagrams, refer to the "INTERNAL UNITS VARIANTS" section.

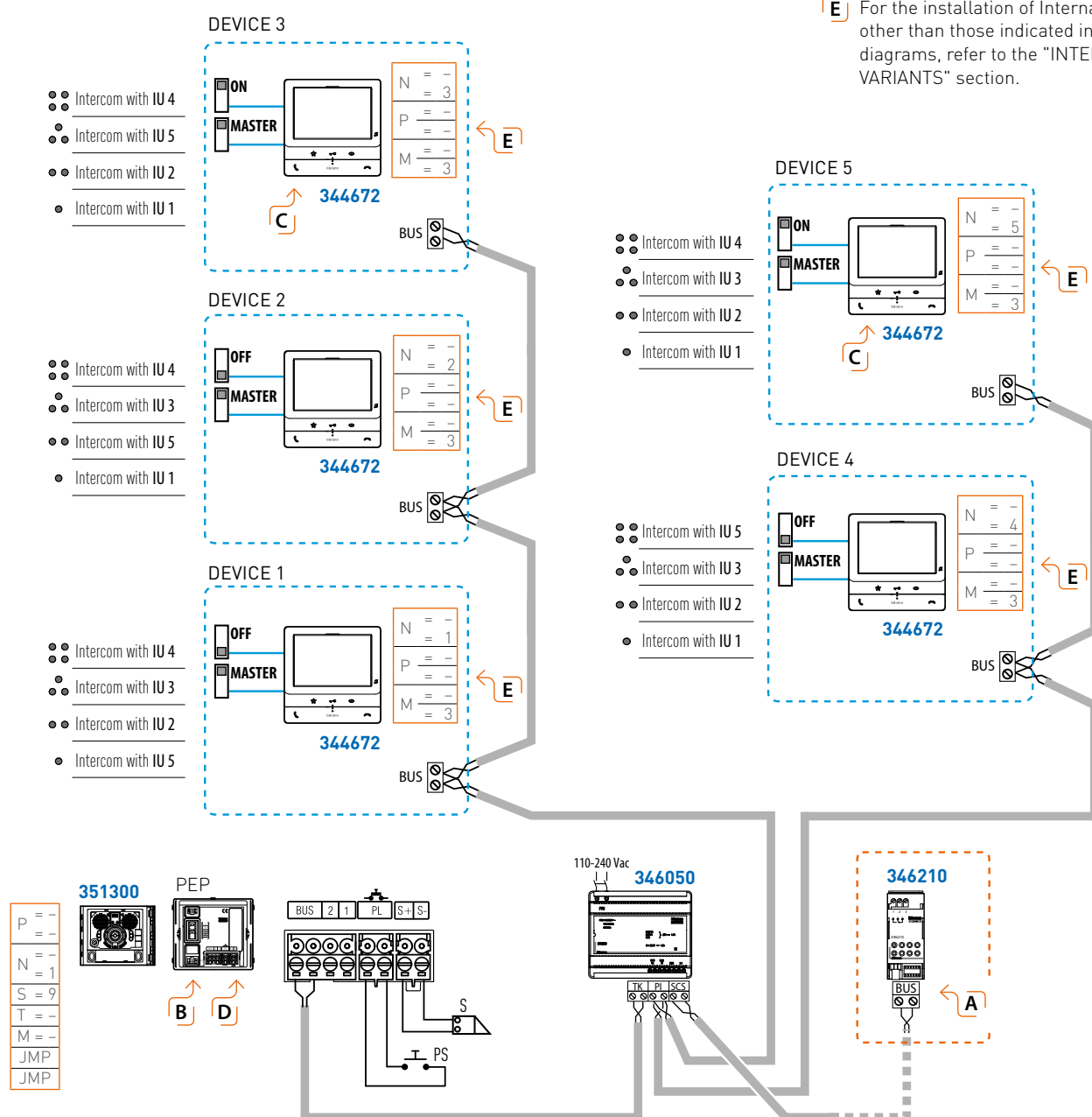

# Two-family system, 1 EP and 3 IU for each apartment with "Internal intercom and among apartments" function

ITEM	DESCRIPTION
351200	SFERA AV
344672	CLASSE 100V16E video internal unit
346050	Power supply
346210	Staircase light actuator
PEP	Main Entrance Panel
PS	Door lock release pushbutton
S	Electrical door lock 18 V 4 A impulsive 250 mA holding current (30 Ohm max)

### ⚠ CAUTION

- Configure and connect the Jumpers with the system NOT POWERED. Also, every time that the configuration is changed, it will be necessary to disconnect the power supply and then reconnect it after approximately 1 minute.
- It is possible to install up to 3 CLASSE 100 video internal units per apartment with MASTER-SLAVE function. Upon arrival of the call, the MASTER rings and switches on, while the SLAVE units ring. If the call is answered from a SLAVE, the MASTER switches off and the monitor of the SLAVE answering the call switches on.

- A** Move to ON the microswitch on the back of the audio or video internal unit that terminates the LINE.
- B** For the installation of Internal Units other than those indicated in the diagrams, refer to the "INTERNAL UNITS VARIANTS" section.
- C** Optional actuator for the control of additional functions (e.g. staircase lights, additional door locks, various activations). For the connection and the configuration, please refer to the technical sheet of the device.

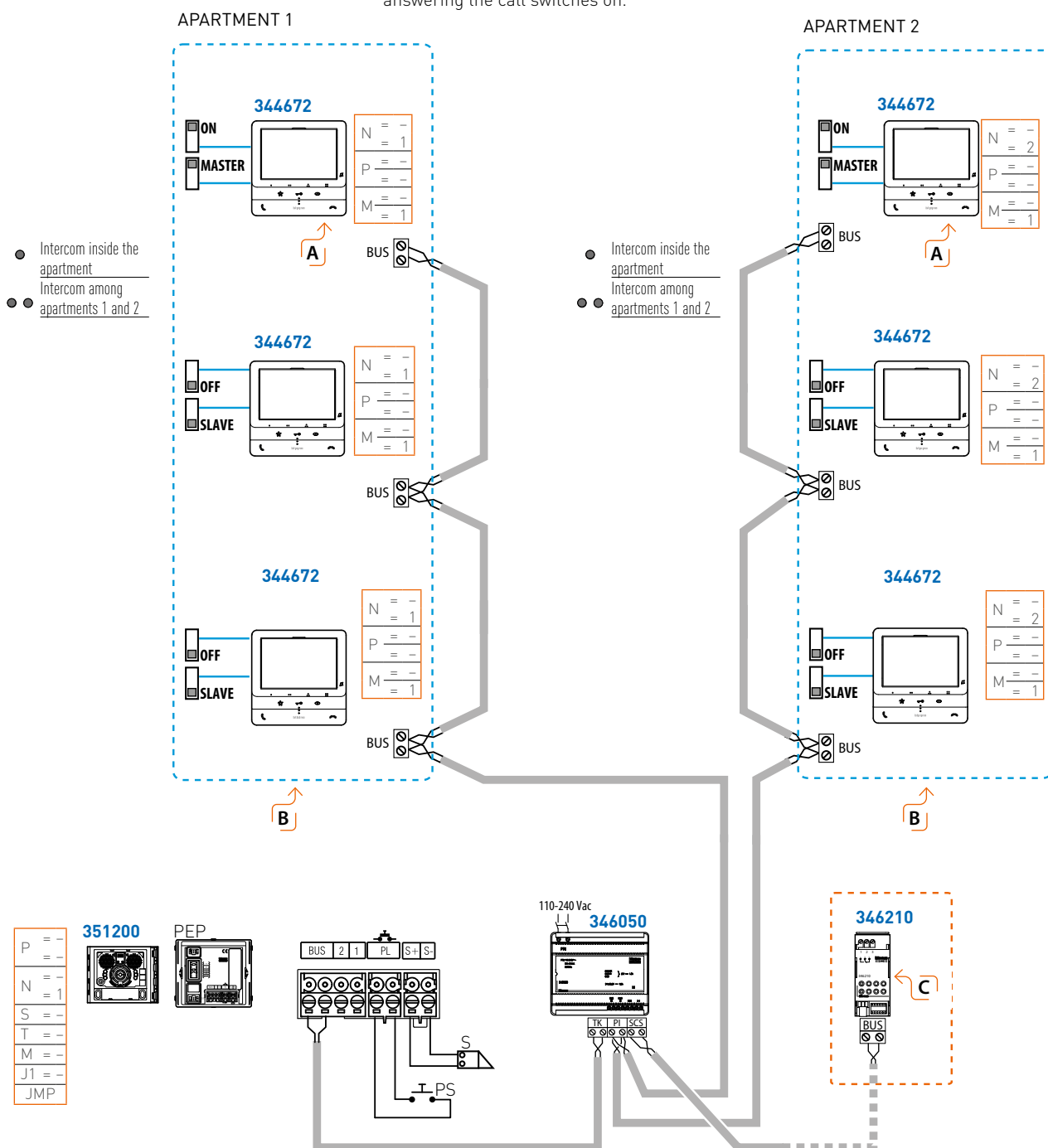

# Intercom in apartment without interface 346850

ITEM	DESCRIPTION
351200	SFERA A/V module
352000	SFERA pushbutton module
344292	CLASSE 100A16M internal unit
344672	CLASSE 100V16E video internal unit
346050	Power supply
346210	Actuator
PEP	Main Entrance Panel
PS	Door lock release pushbutton
S	Electrical door lock 18 V 4 A impulsive 250 mA holding current (30 Ohm max)

The apartment intercom conversation is interrupted when a call is made from the EP (even if to another apartment). The system only handles one intercom call at the time.

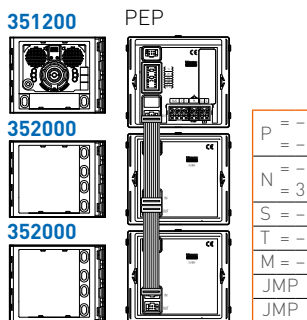
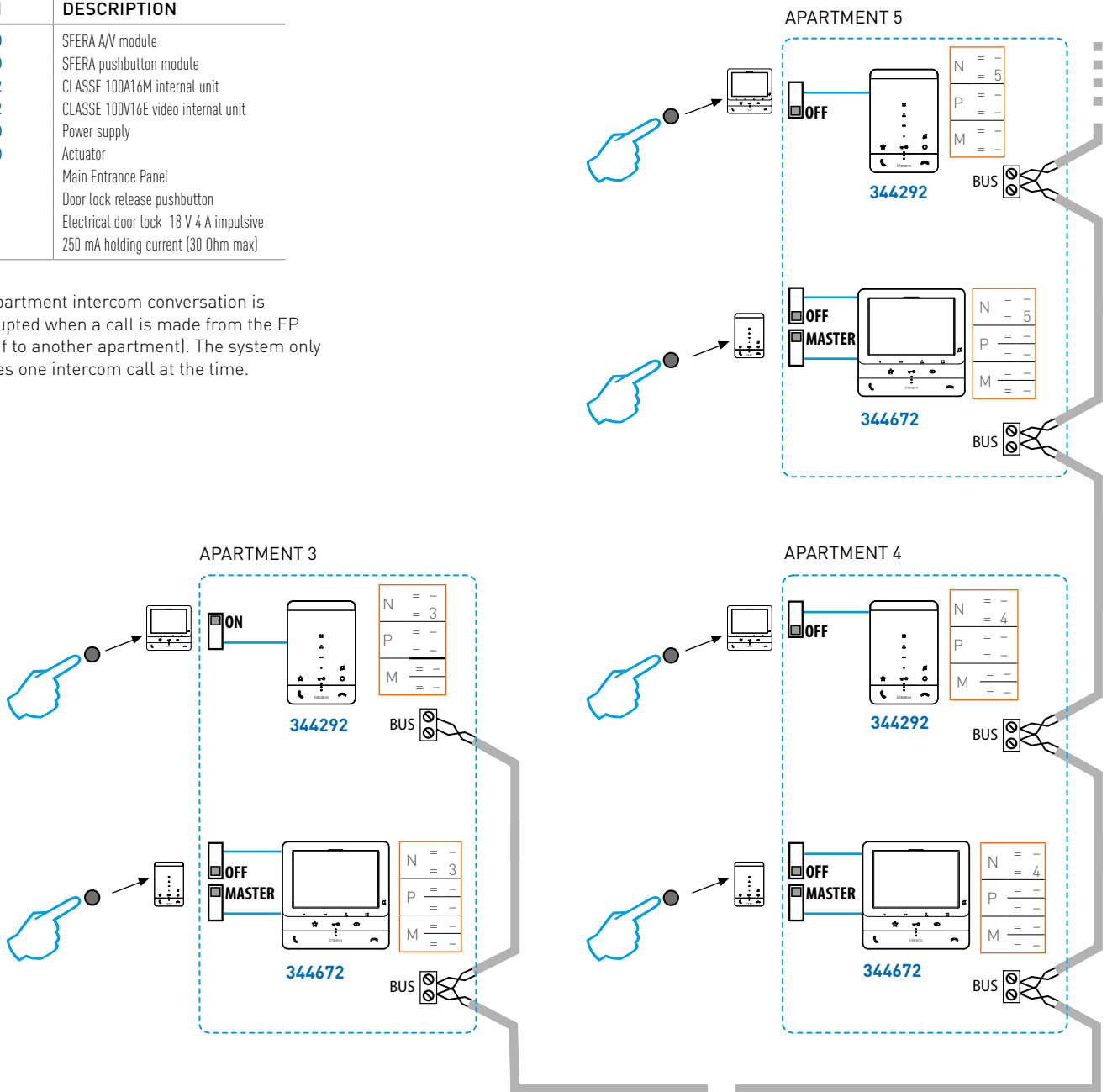

Must be configured with  $N \geq 3$

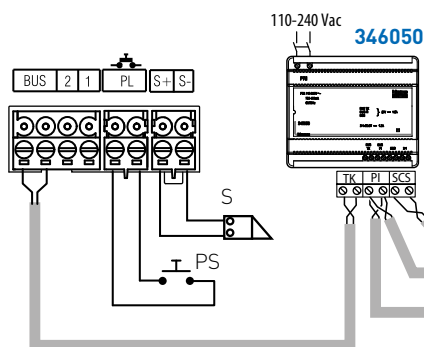

**346210** Optional actuator for the control of additional functions (e.g. staircase lights, additional door locks, various activations). For the connection and the configuration, please refer to the technical sheet of the device.

# Multifamily system with 1 main video EP, 2 risers and max. 5 intercom among apartments

ITEM	DESCRIPTION
351100	SFERA speaker module
352000	SFERA pushbutton module
352400	Camera module
344672	SFERA WIDE ANGLE N/D
346050	Power supply
346210	Actuator
PEP	Main Entrance Panel
PS	Door lock release pushbutton
S	Electrical door lock 18 V 4 A impulsive 250 mA holding current (30 Ohm max)

**CAUTION**

- Configure and connect the Jumpers with the system NOT POWERED. Also, every time that the configuration is changed, it will be necessary to disconnect the power supply and then reconnect it after approximately 1 minute.
- Calls from the entrance panels take priority and stop the intercom call.

- A** Optional actuator for the control of additional functions (e.g. staircase lights, additional door locks, various activations). For the connection and the configuration, please refer to the technical sheet of the device.
- B** Move to ON the microswitch on the back of the audio or video internal unit that terminates each apartment line.
- C** For the installation of Internal Units other than those indicated in the diagrams, refer to the "INTERNAL UNITS VARIANTS" section.

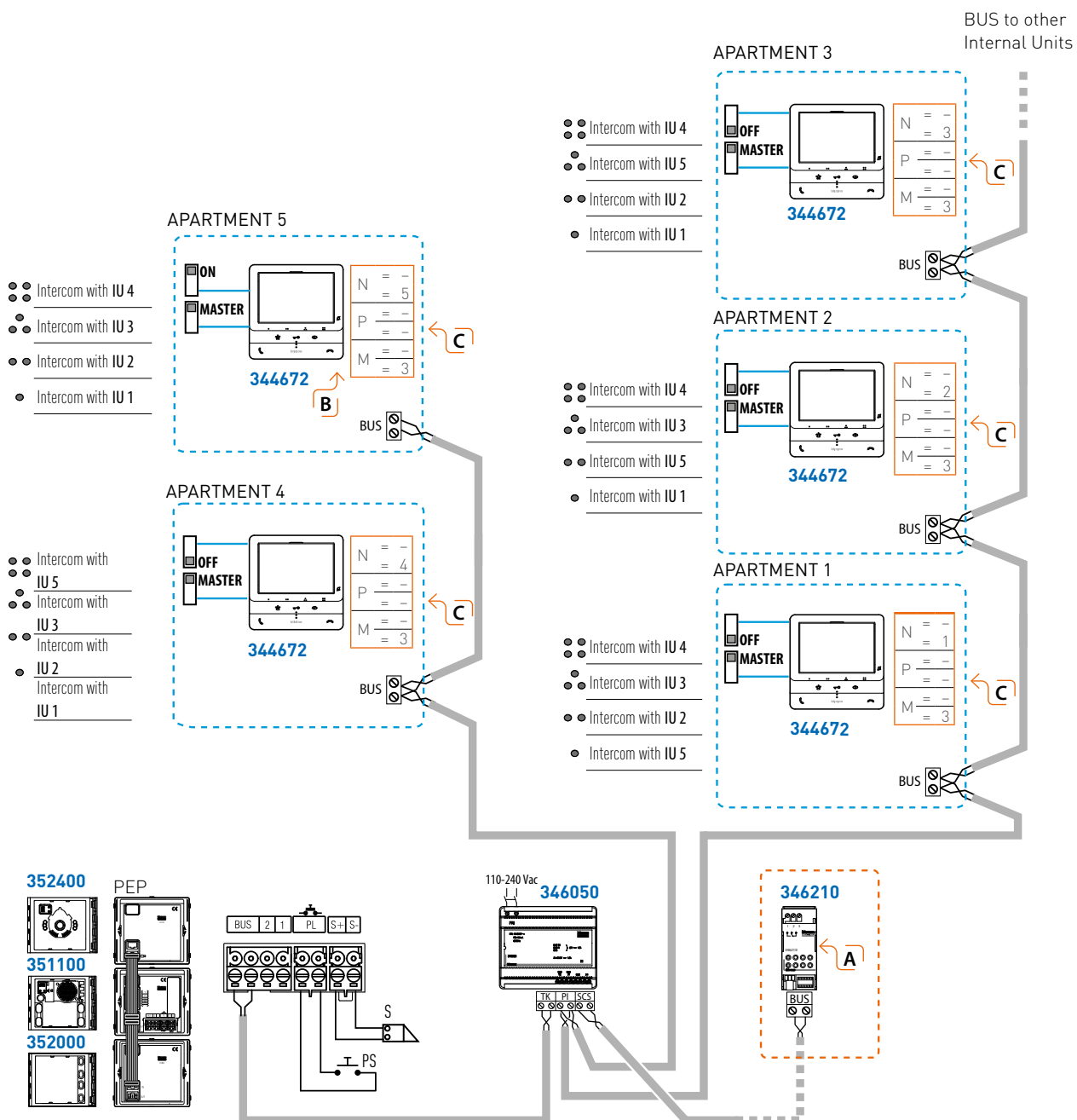

# Multifamily system with 2 EP (1 with separate camera, 2 additional cameras and riser with apartment interface)

ITEM	DESCRIPTION
351200	SFERA A/V module
351100	SFERA speaker module
352100	SFERA pushbutton module
344652	CLASSE 100V16B handsfree video internal unit
346050	Power supply
346850	Apartment interface
347400	Coax / 2 wires interface
F441	Audio/video node
PEP	Main Entrance Panel
PES	Secondary Entrance Panel
PS1-PS2	Door lock release pushbutton
S1 - S2	Electrical door lock 18 V 4 A impulsive 250 mA holding current (30 Ohm max)

**⚠ CAUTION**

■ Configure and connect the Jumpers with the system NOT POWERED. Also, every time that the configuration is changed, it will be necessary to disconnect the power supply and then reconnect it after approximately 1 minute.

**A** For the installation of Internal Units other than those indicated in the diagrams, refer to the "INTERNAL UNITS VARIANTS" section.

**B** Audio Entrance Panels associated to the cameras must belong to the SFERA, LINEA 300 and 346991 series, and must be directly connected to the SCS clamps of audio/video node F441.

**C** The apartment interface is connected as a standard video internal unit.

**CONNECTION LIMITS**

4 video EP, max. 4 lines on out of the AV node F441

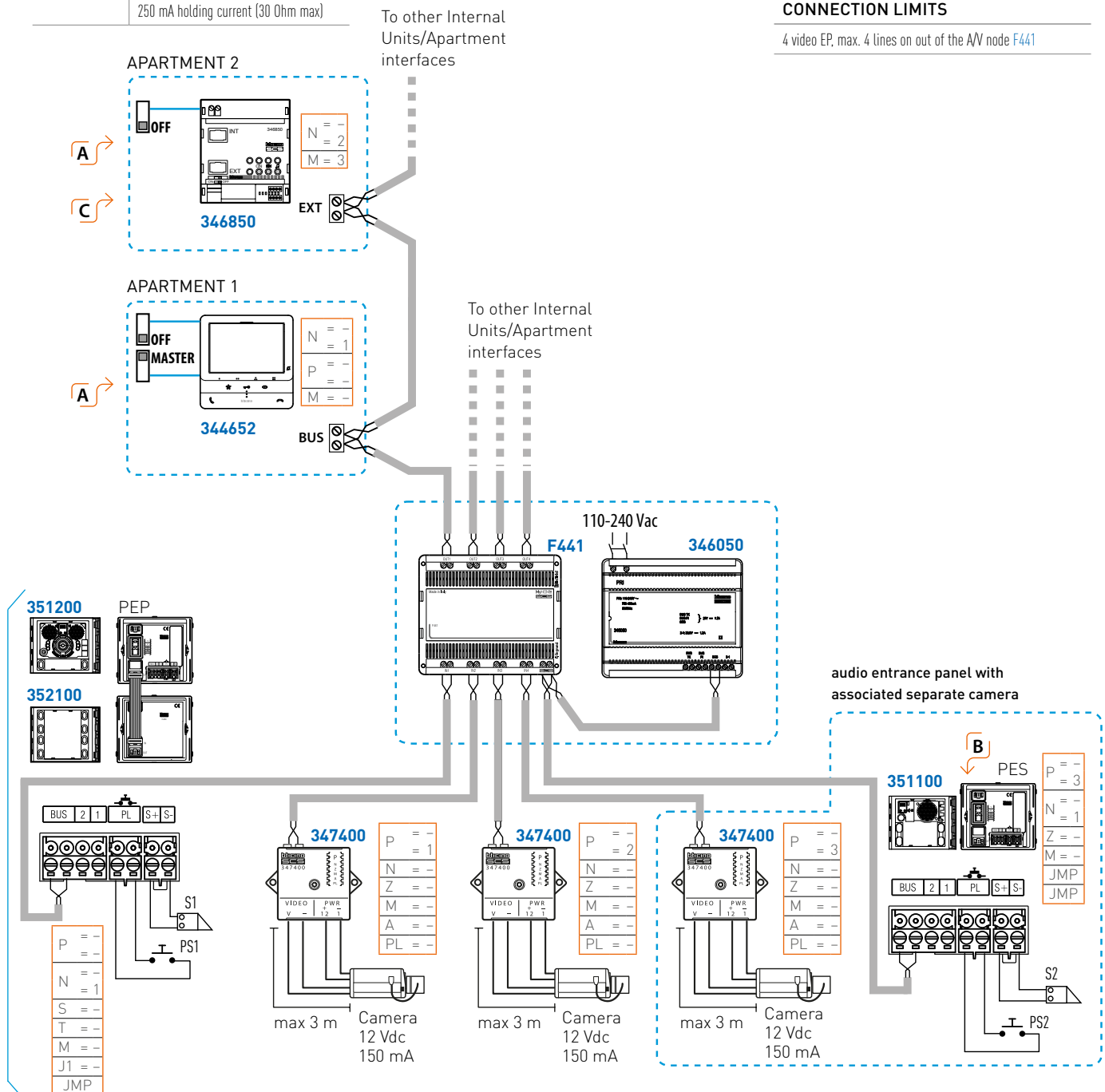

# System in apartment with 2 WIRES analog interface 349410

ITEM	DESCRIPTION
349410	Analog/2 WIRES interface
351200	SFERA A/V module
344672	CLASSE 100V16E video internal unit
F441	Audio video node
346050	Power supply
347400	Coax / 2 wires interface
PS	Door lock release pushbutton
S	Electrical door lock 18 V 4 A impulsive 250 mA holding current (30 Ohm max)
PEA	Apartment entrance panel

**A** Connection for systems with direct lock control

CLAMPS 349410	VIDEO	AUDIO
1	1	1 and S+ (of the actuator)
2	2	-
3	3	3
4	4	4
5	5	5
6	6	<b>A</b>
7	7	-
8	8	-
9	-	-
10	-	-
11	14	14 (optional)
12	-	-

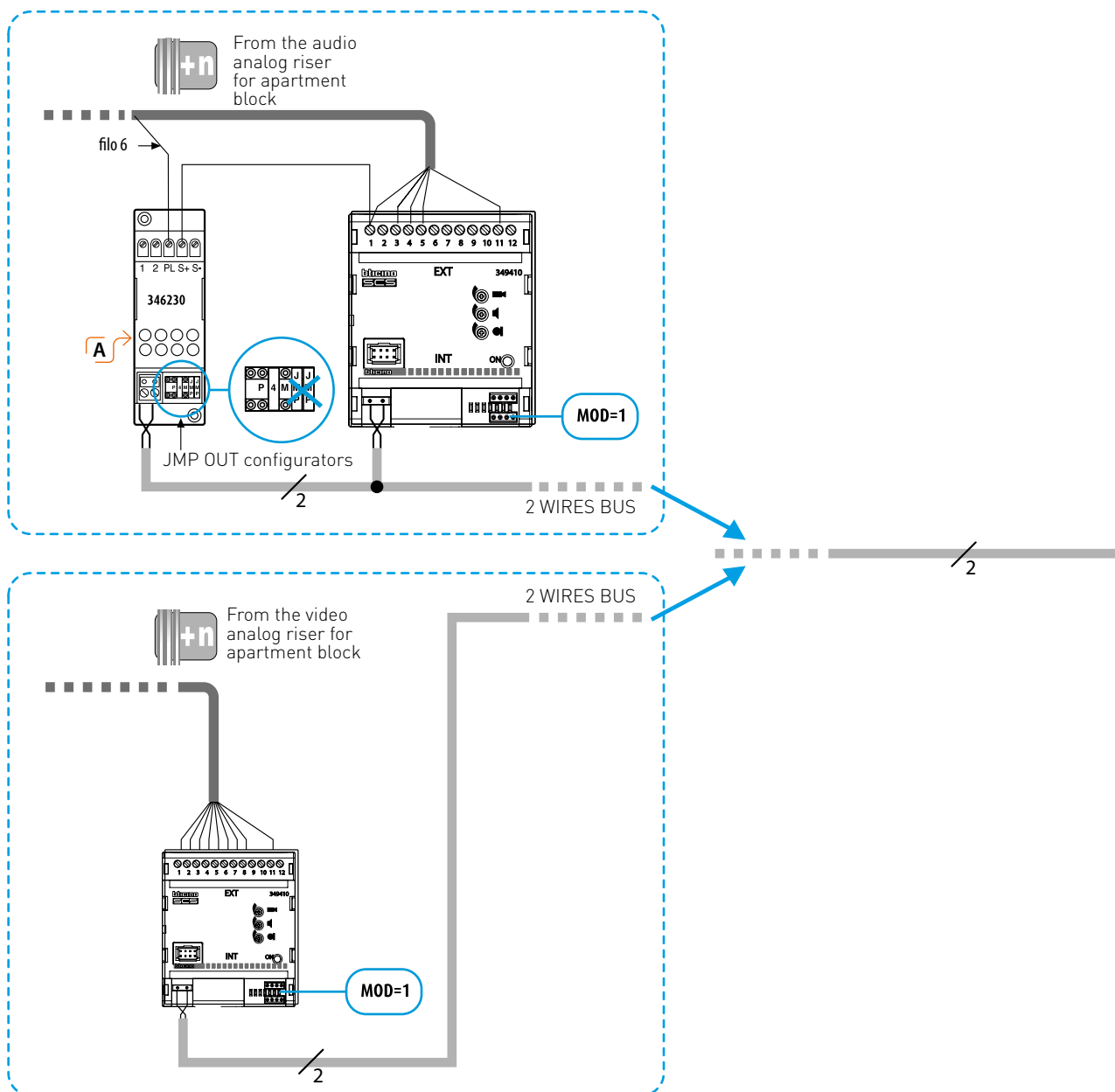

**CAUTION**

- No analog side addressed actuations are possible.
- For wiring and system limit purposes, interface 349410 must be considered the same as a 2 WIRES EP.
- Configure and connect the Jumpers with the system NOT POWERED. Also, every time that the configuration is changed, it will be necessary to disconnect the power supply and then reconnect it after approximately 1 minute.
- In case of audio riser, the video IU activates without displaying an image.
- Classe 300EOS is NOT compatible with this type of system.

**B** Move to ON the microswitch on the back of the last audio or video internal unit of the line or riser.

PRIVATE APARTMENT

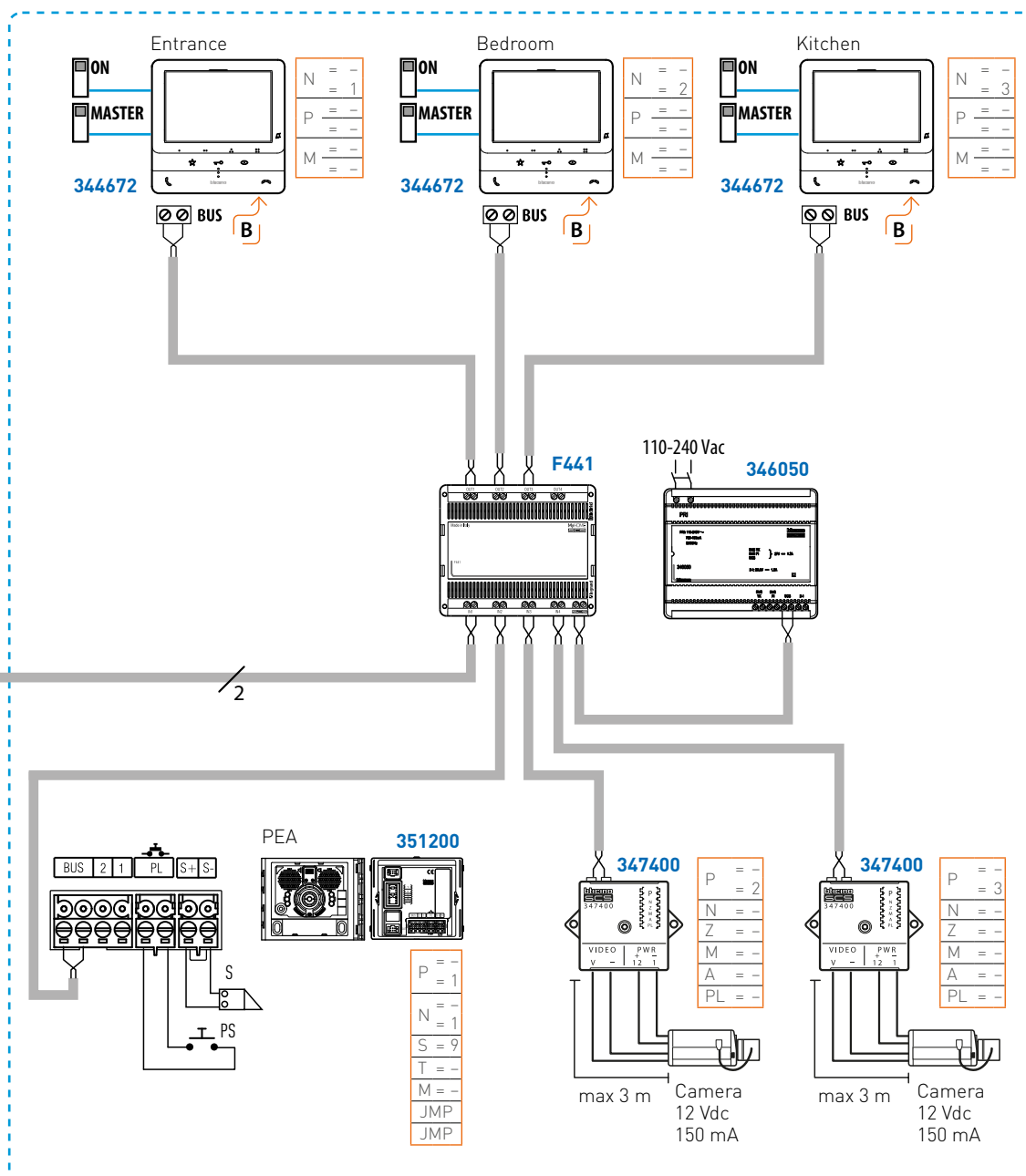

# System in apartment with apartment interface

ITEM	DESCRIPTION
351200	SFERA A/V module
344672	CLASSE 100V16E video internal unit
346050	Power supply
346850	Apartment interface
F441	Audio/video node
347400	Coax / 2 wires interface
PEA	Apartment Entrance Panel
PS	Door lock release pushbutton
S	Electrical door lock 18 V 4 A impulsive - 250 mA holding current (30 Ohm max)

**CAUTION**

- Configure the apartment Entrance Panels from P = 1.
- Configure the apartment IU from N = 1
- As for one-family systems, all internal units must be configured as MASTER. The internal unit configured with N = 1 rings and switches on, while the others ring. If the call is answered from an internal unit with the monitor switched off, the monitor of the internal unit configured with N = 1 switches off and the monitor of the internal unit being used for answering switches on.

- A** For the realisation of the Entrance Panel, it is possible to use SFERA, LINEA 3000 or LINEA 2000 pushbutton panels. For further information, see the "ENTRANCE PANEL VARIANTS" section.
- B** For the installation of Internal Units other than those indicated in the diagrams, refer to the "INTERNAL UNITS VARIANTS" section.
- C** Move to ON the microswitch of the internal unit that terminates the line.

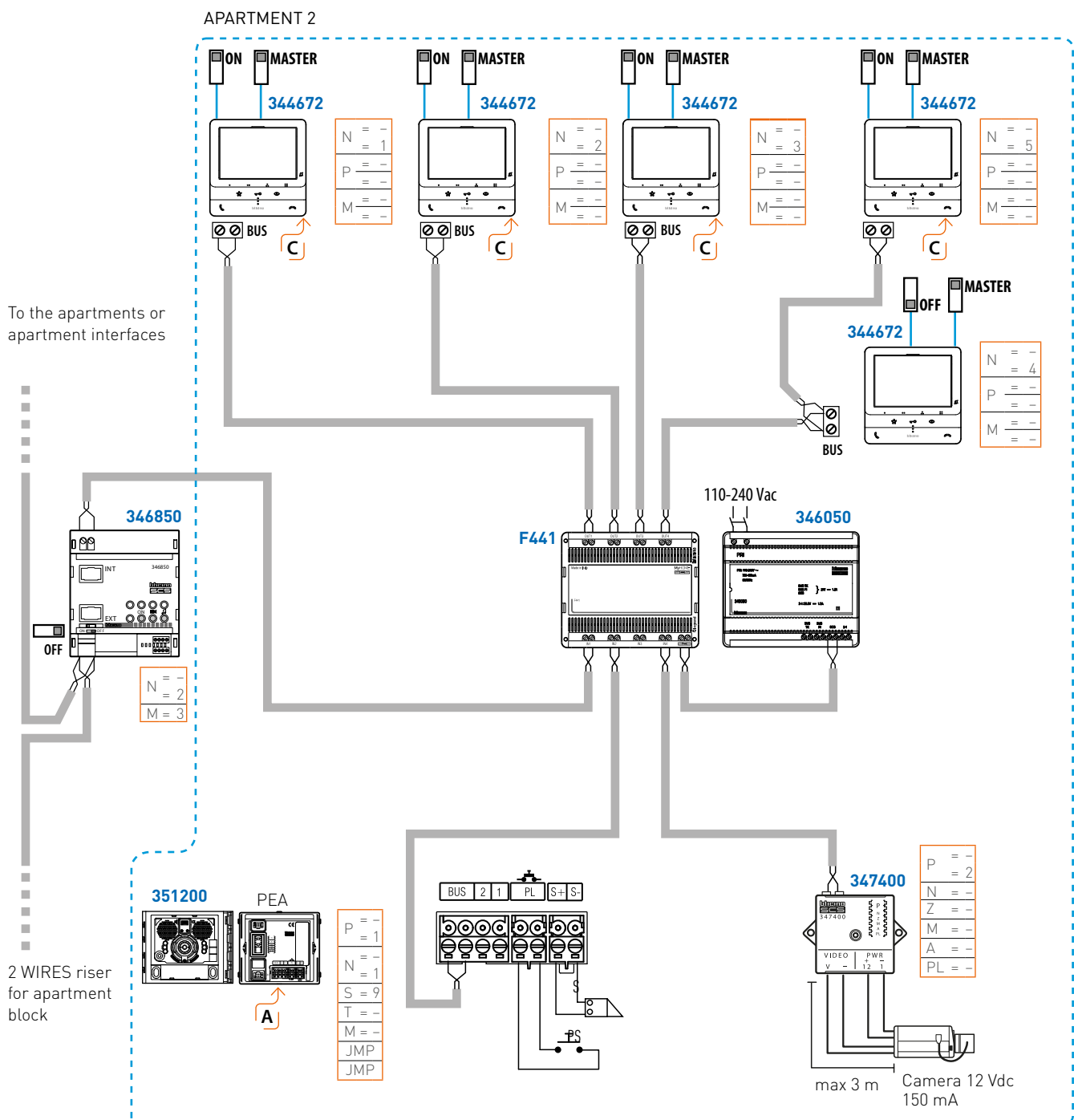



# System line expansion with interface 346851

ITEM	DESCRIPTION
351200	AV module. SFERA
346050	Power supply
346851	System expansion interface
PEP	Main Entrance Panel
PS	Door lock release pushbutton
S	Electrical door lock 18 V 4 A impulsive - 250 mA holding current (30 Ohm max)

**CAUTION**

- After the system expansion module 346851 there are 200 m of line B available (interface 346851 - Furthest internal unit). It is possible to install up to a maximum of 3 interfaces 346850 e 346851 in cascade, only 2 of which regenerate the signal.

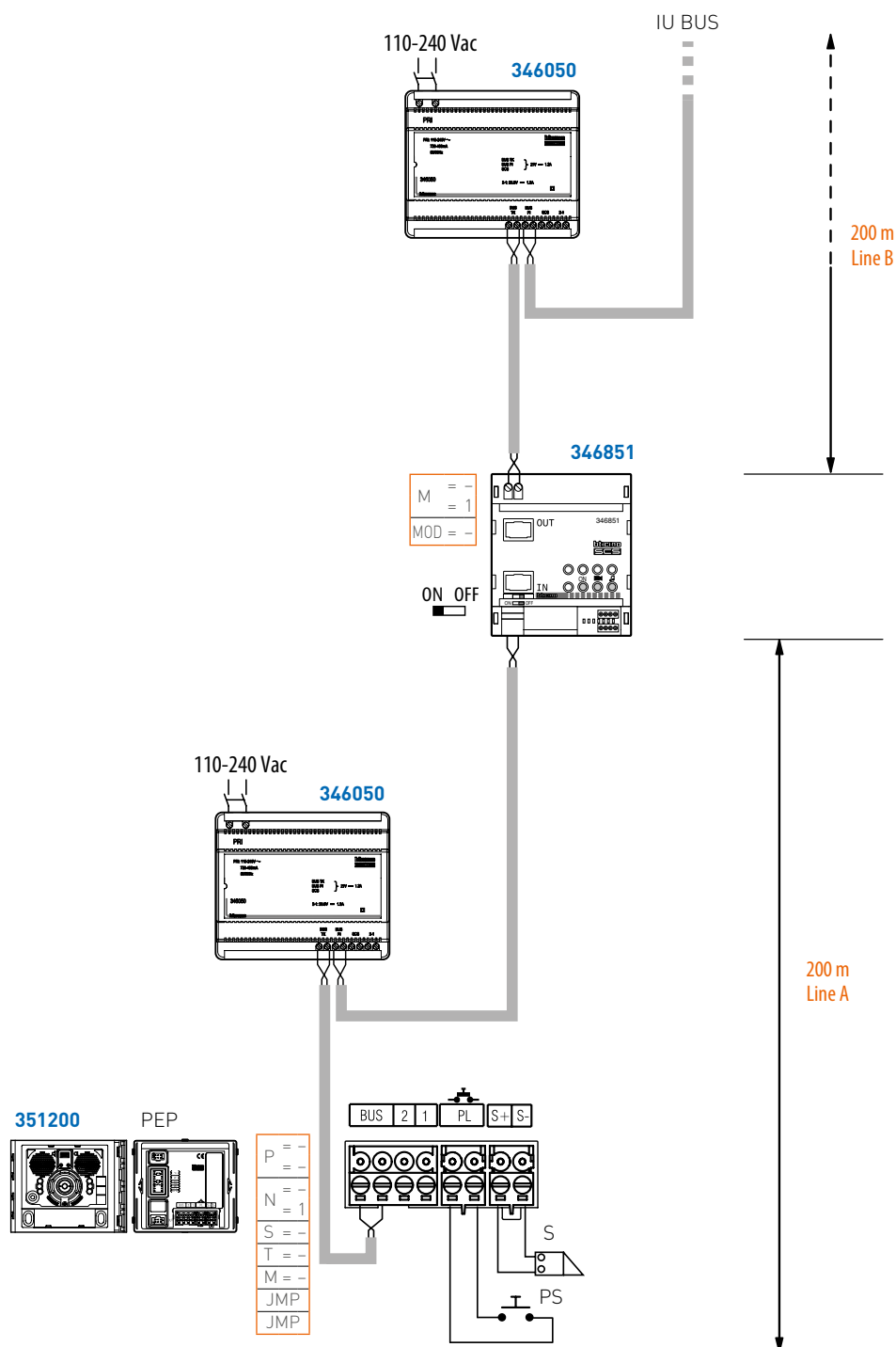

# Multifamily system with 39 risers with independent audio

ITEM	DESCRIPTION
351200	SFERA A/V module
352500	SFERA Display Module
352400	Camera module SFERA WIDE ANGLE N/D
351100	SFERA speaker module
352100	SFERA 8-pushbutton module
353000	SFERA Keypad Module
344652	CLASSE 100V16B handsfree video internal unit
344672	CLASSE 100V16E video internal unit
346050	Power supply
346850	Apartment interface
346851	System expansion interface
PEP	Main Entrance Panel
PEM	Riser Entrance Panel
PS	Door lock release pushbutton
PS1 PS2 PS3 PS4	Electrical door lock 18 V 4 A impulsive - 250 mA holding current (30 Ohm max)
F441	Audio video node

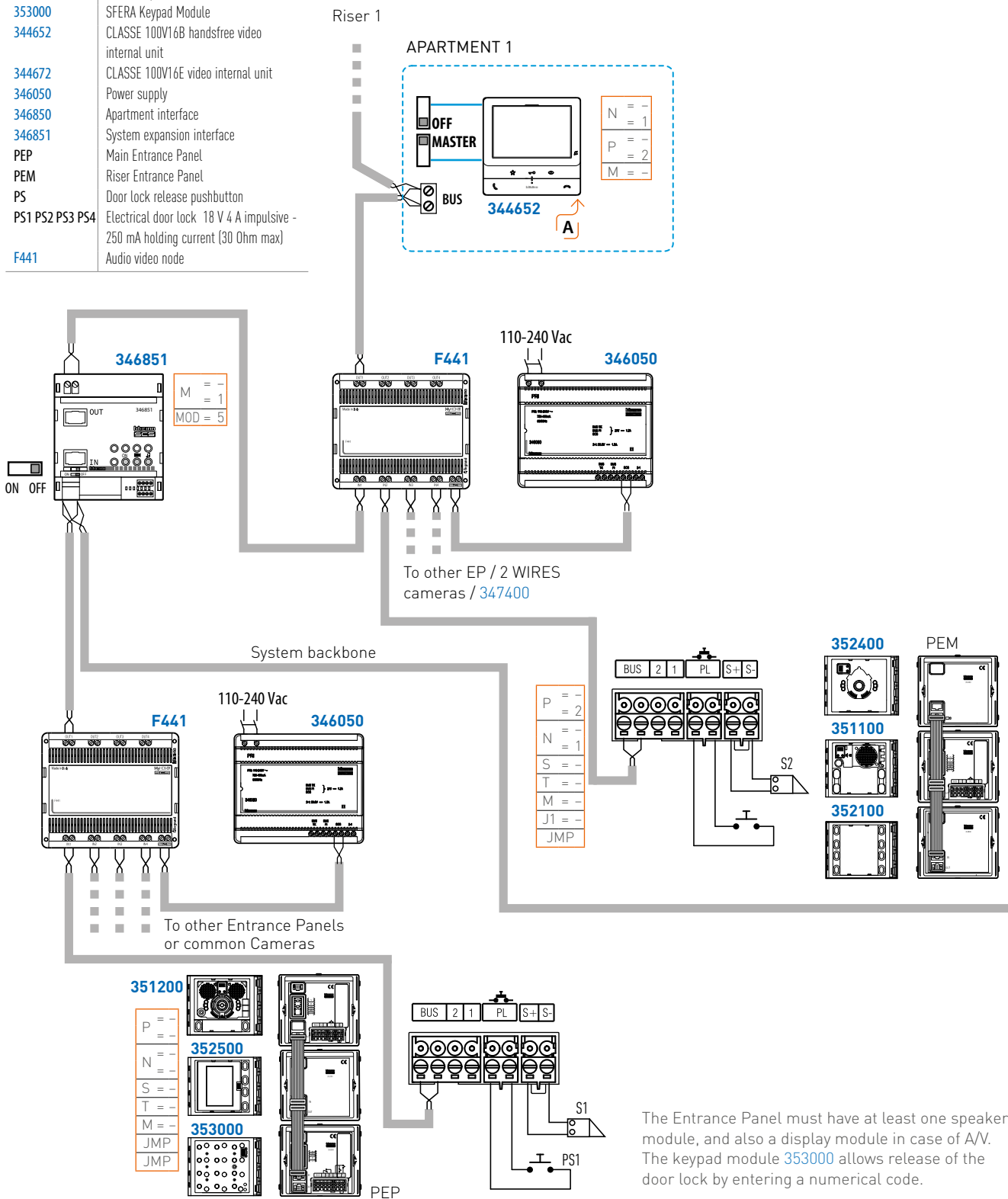

The Entrance Panel must have at least one speaker module, and also a display module in case of A/V. The keypad module 353000 allows release of the door lock by entering a numerical code.

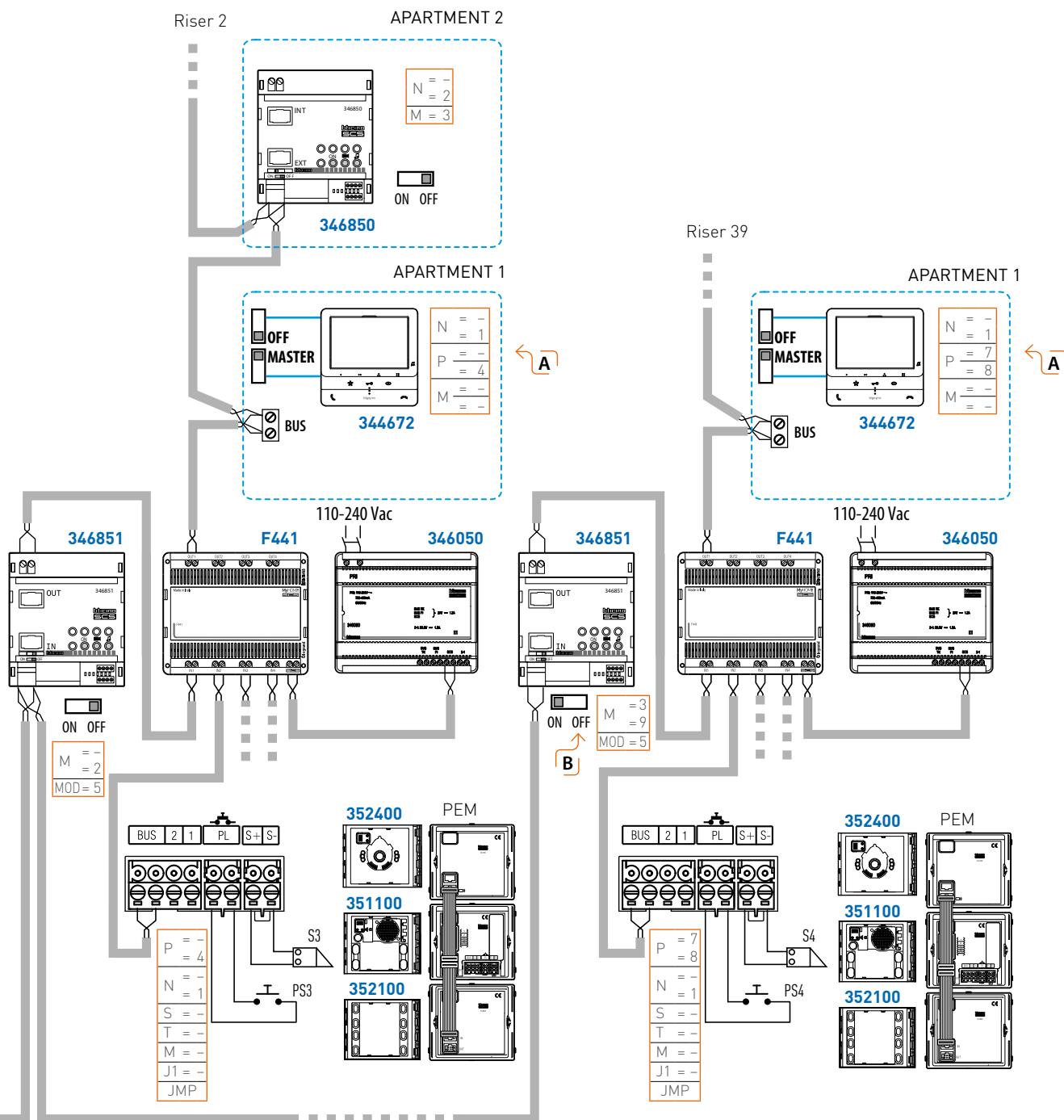

**CAUTION**

- For the main Entrance Panel, riser Internal Units will have an address equal to (the riser number x100) + no. of the Internal Unit. E.g. IU 15 of riser 9; address for the main EP  $9 \times 100 + 15 = 915$ .
- Configure the Internal Units from N = 1
- It is possible to install up to a maximum of 3 interfaces 346850 e 346851 in cascade, only 2 of which regenerate the signal.

- A** For the installation of Internal Units other than those indicated in the diagrams, refer to the "INTERNAL UNITS VARIANTS" section.
- B** Move to ON the microswitch of the 346851 interface that terminates the line.

# One-family system with max 16 cameras or Entrance Panels

ITEM	DESCRIPTION
3499	Line terminator
344672	CLASSE 100V16E video internal unit
F441	Audio/video node
346050	Power supply
343081	Linea 3000 EP
347400	COAX / 2 wires interface
PEP	Main Entrance Panel
PS	Door lock release pushbutton (optional)
S	Electrical door lock 18 V 4 A impulsive - 250 mA holding current (30 Ohm max)

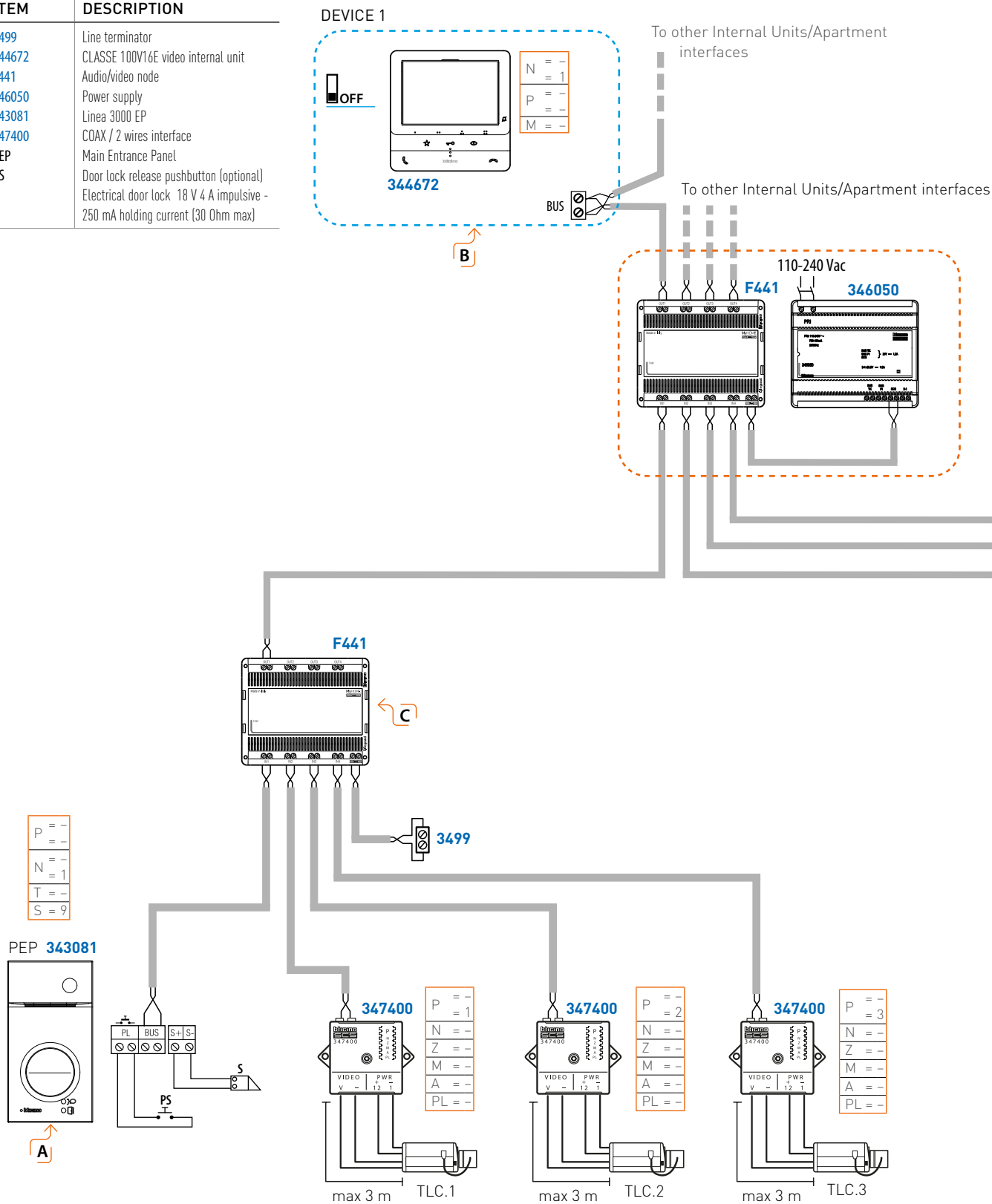

**CAUTION**

By using the nodes in cascade, the distances between video source and the furthest internal unit are halved (max 100 with cable 336904/336905)

- A)** For the realisation of the Entrance Panel, it is possible to use all the 2 WIRES pushbutton panels.
- B)** It is possible to install all the video internal units of the 2 WIRES range.
- C)** Only use one output per node and allow for a terminator 3499 connected to the SCS clamp

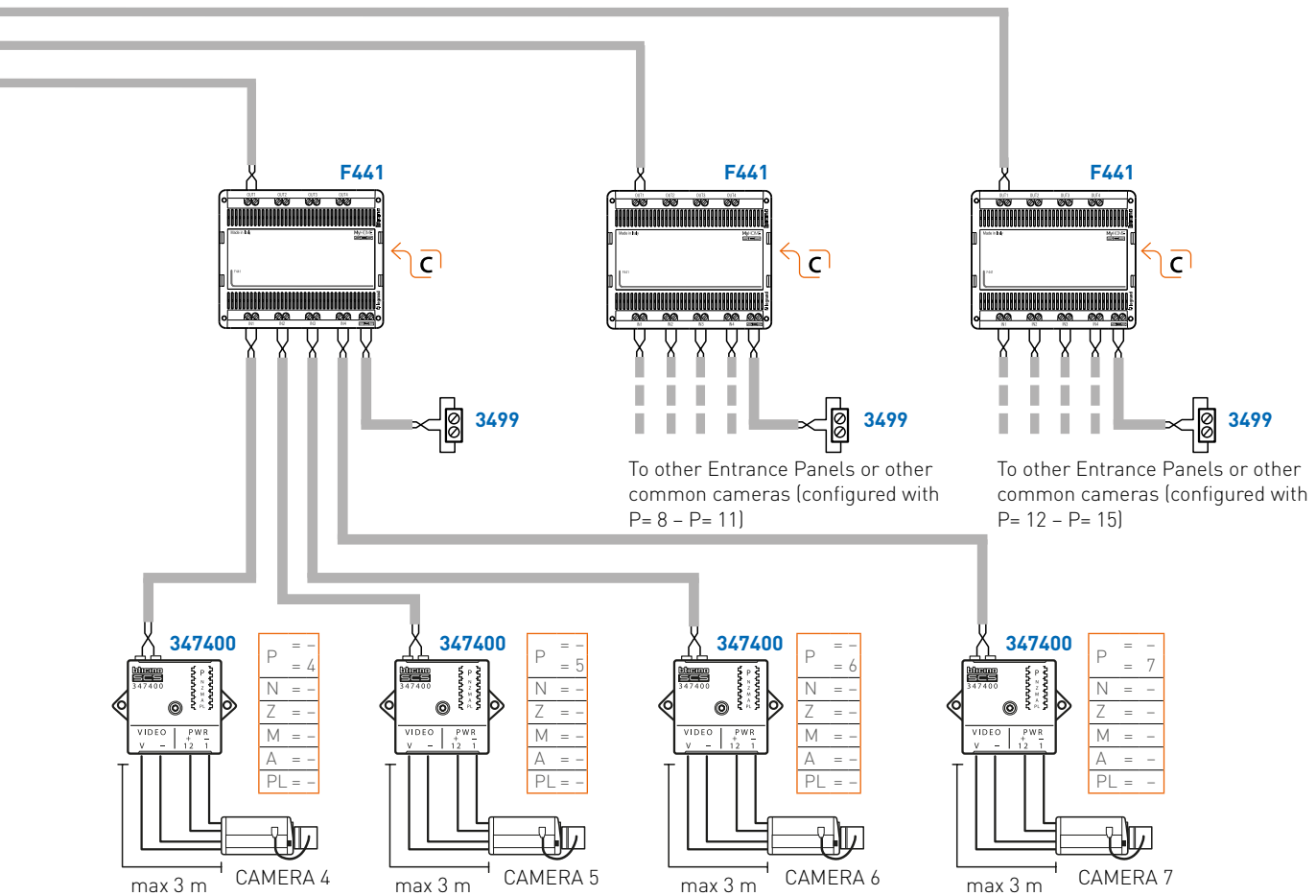

# System with module 346851 for Entrance Panel line doubling; max. 39 independent risers and apartment interfaces

ITEM	DESCRIPTION
351200	SFERA A/V module
352500	SFERA display module
353000	SFERA Keypad Module
352400	Camera module SFERA WIDE ANGLE N/D
352100	SFERA pushbutton module
351100	SFERA speaker module
344652	CLASSE 100V16B handsfree video
346050	internal unit
	Power supply
346850	Apartment interface
346851	System expansion interface
PEP	Main Entrance Panel
PS1-PS2-PS3	Door lock release pushbutton
S1-S2-S3	Electrical door lock 18 V 4 A impulsive - 250 mA holding current (30 Ohm max)
PEM	Riser Entrance Panel
F441	Audio video node

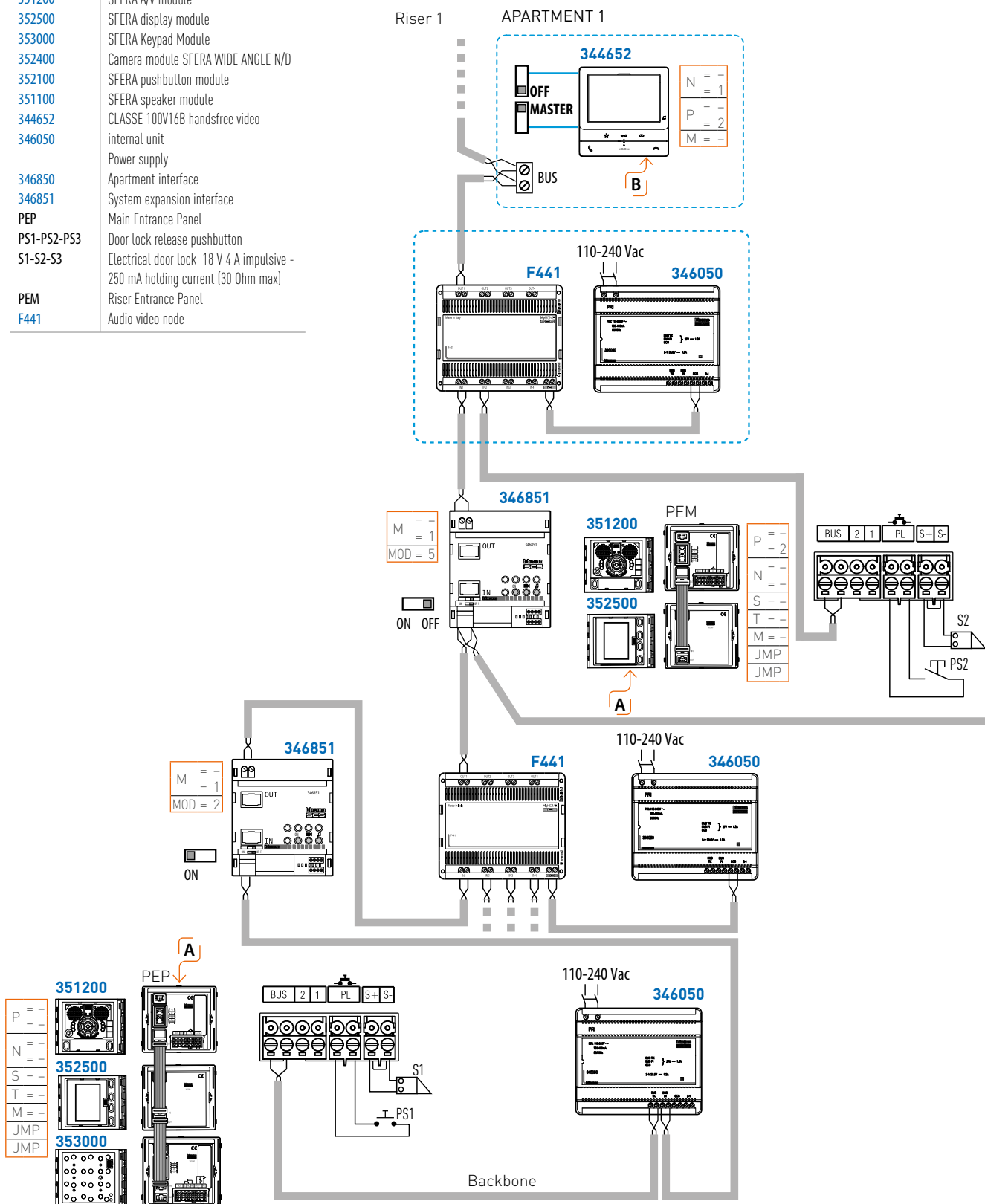

The Entrance Panel must have at least one speaker module, and also a display module in case of A/V.

**CAUTION**

For the main Entrance Panel, riser Internal Units will have an address equal to (the riser number x 100) + no. of the Internal Unit.  
E.g. IU 15 of riser 9; address for the main EP  $9 \times 100 + 15 = 915$ .

- Configure the riser Internal Units from N = 1
- It is possible to install up to a maximum of 3 interfaces 346850 e 346851 in cascade, only 2 of which regenerate the signal.

- A** For the realisation of the riser Entrance Panel, it is possible to use SFERA or LINEA 300 pushbutton panels. For further information, see the "ENTRANCE PANEL VARIANTS" section.
- B** For the installation of Internal Units other than those indicated in the diagrams, refer to the "INTERNAL UNITS VARIANTS" section.

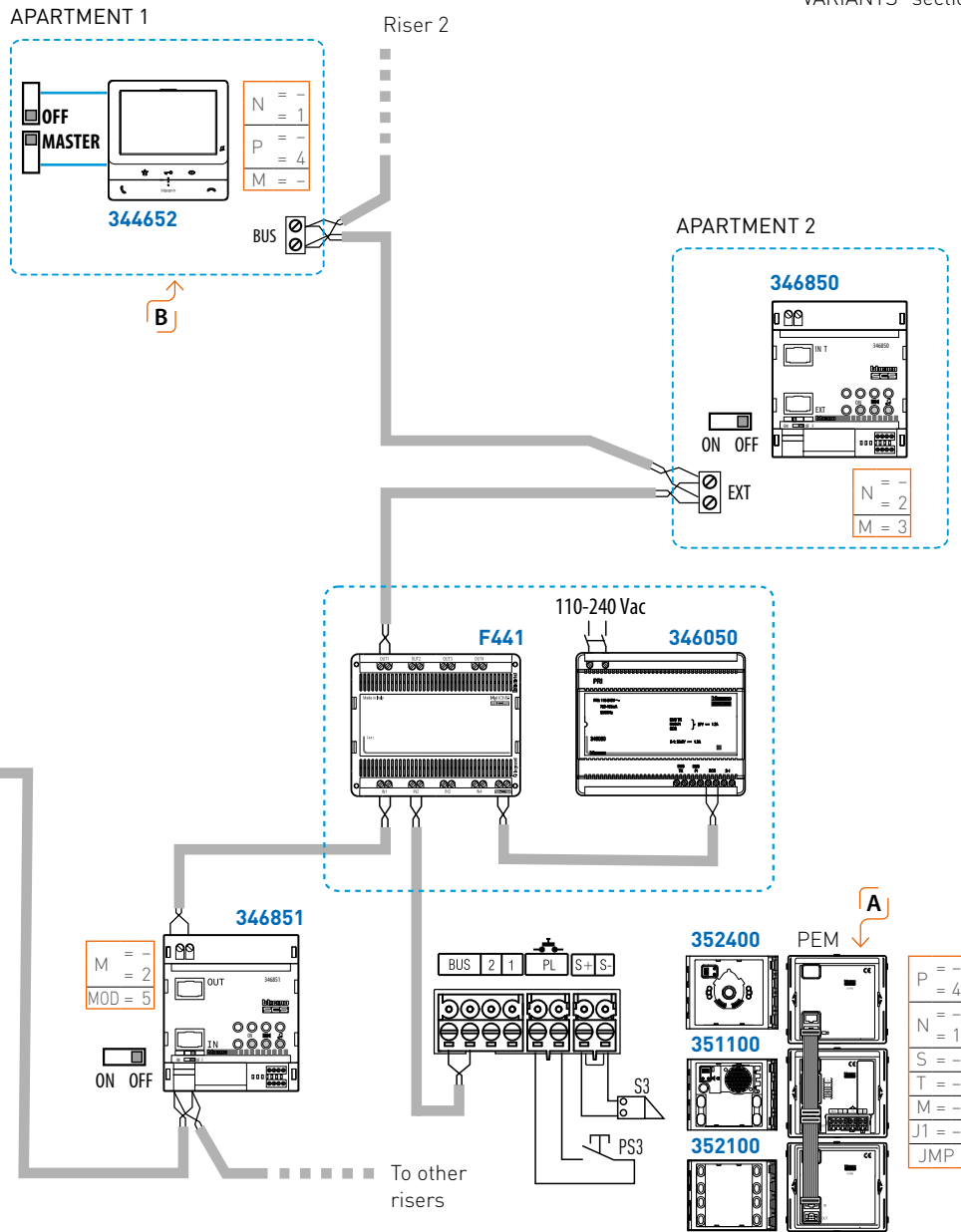

# System with max 39 independent risers and riser extension (100 video IU)

ITEM	DESCRIPTION
351200	SFERA A/V module
352500	SFERA display module
353000	SFERA keypad module
352400	N/D camera module
	SFERA WIDE ANGLE
351100	SFERA speaker module
352100	SFERA pushbutton module
344652	CLASSE 100 V16B handsfree video internal unit
346050	Power supply
346851	System expansion module
PEP	Main Entrance Panel
PEM	Riser Entrance Panel
F441	Audio video node
S1 - S2 - S3	Electrical door lock 18 V 4 A impulsive - 250 mA holding current (30 Ohm max)
PS1-PS2-PS3	Door lock release pushbutton

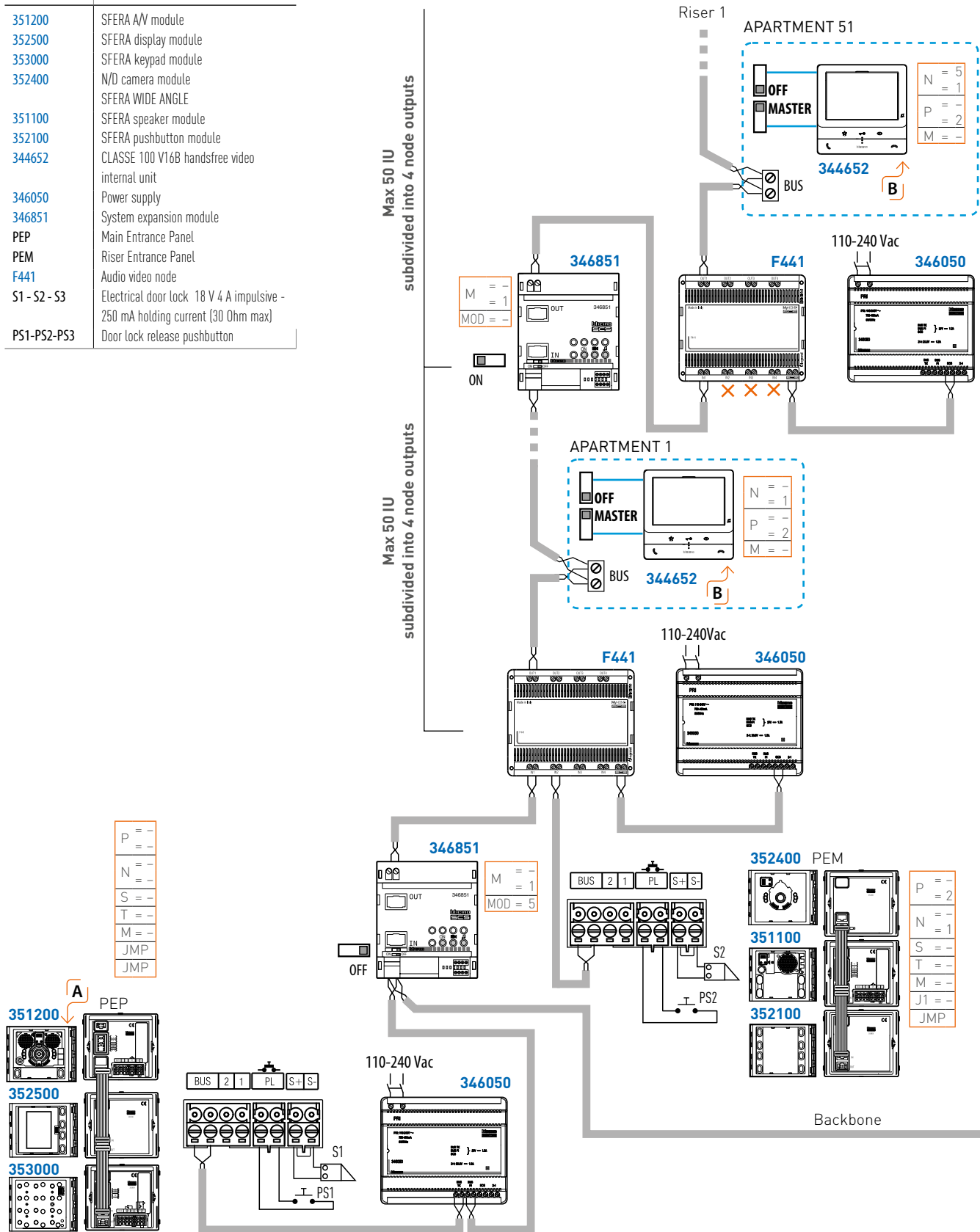

The Entrance Panel must have at least one speaker module, and also a display module in case of A/V.



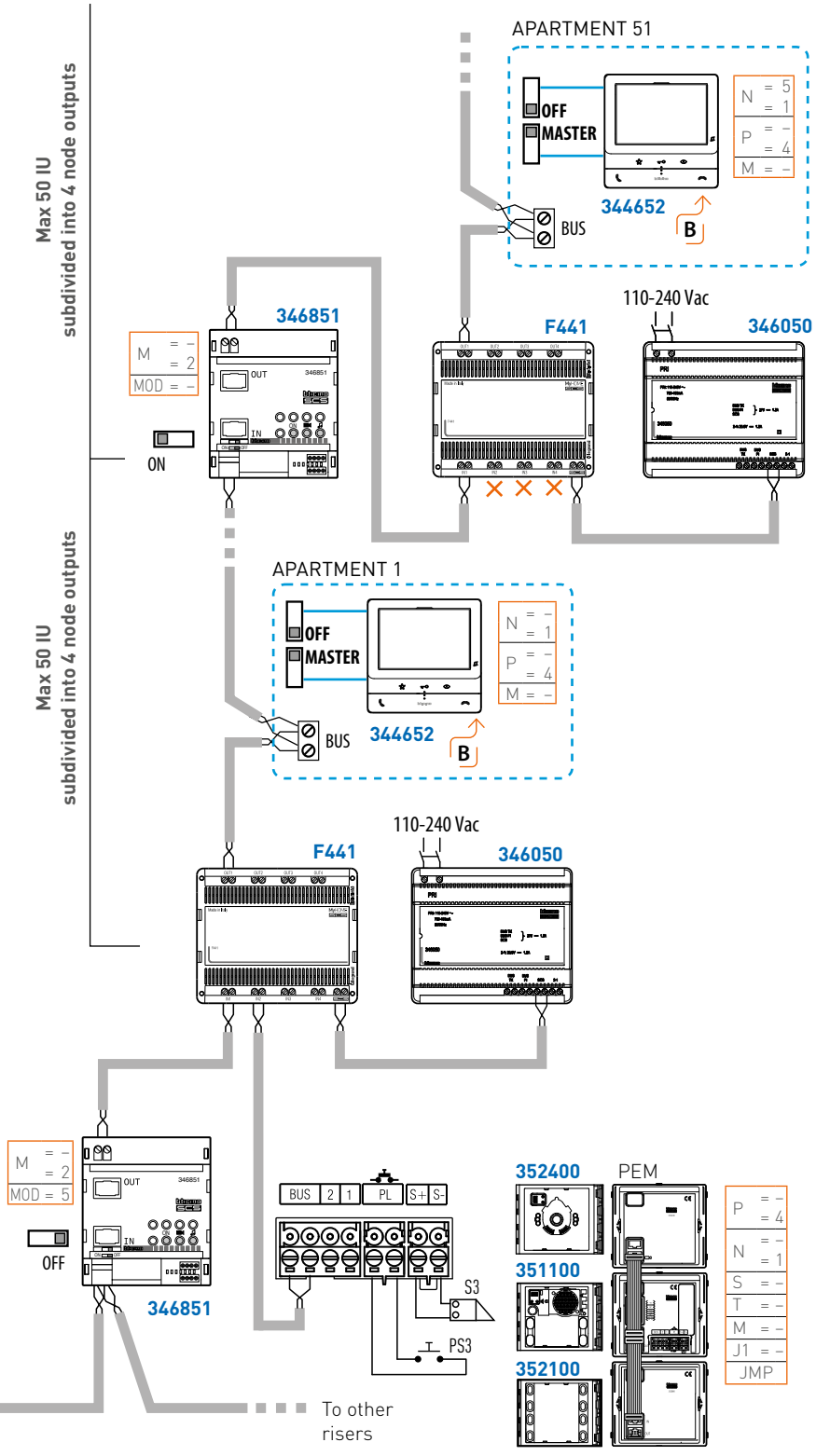

**CAUTION**

- For the main Entrance Panel, riser Internal Units will have an address equal to (the riser number x 100) + no. of the Internal Unit. E.g. IU 15 of riser 9; address for the main EP 9 x 100 + 15 = 915.
- Configure the riser Internal Units from N = 1
- It is possible to install up to a maximum of 3 interfaces 346850 e 346851 in cascade, only 2 of which regenerate the signal.

- A** The Entrance Panel must be created using digital call SFERA modules.
- B** For the installation of Internal Units other than those indicated in the diagrams, refer to the "INTERNAL UNITS VARIANTS" section.

# Internal Units expansion in apartment - (Example up to 10 IU)

ITEM	DESCRIPTION
351300	SFERA WIDE ANGLE AV module
346050	Power supply
346841	Floor shunt
346850	Apartment interface
344672	CLASSE 100V16E video internal unit
F441	Audio video node
S	Electrical door lock 18 V 4 A impulsive - 250 mA holding current (30 Ohm max)
PEA	Apartment Entrance Panel
PS	Door lock release pushbutton

Configuring the IU as indicated, this will ensure the intercom function among all units; when a call is received from the EP, all IU ring, and only the IU configured with N =1 switches on.

For functions other than the ones specified above, contact your local technical-commercial representative or the BTicino technical support service.

## APARTMENT 16

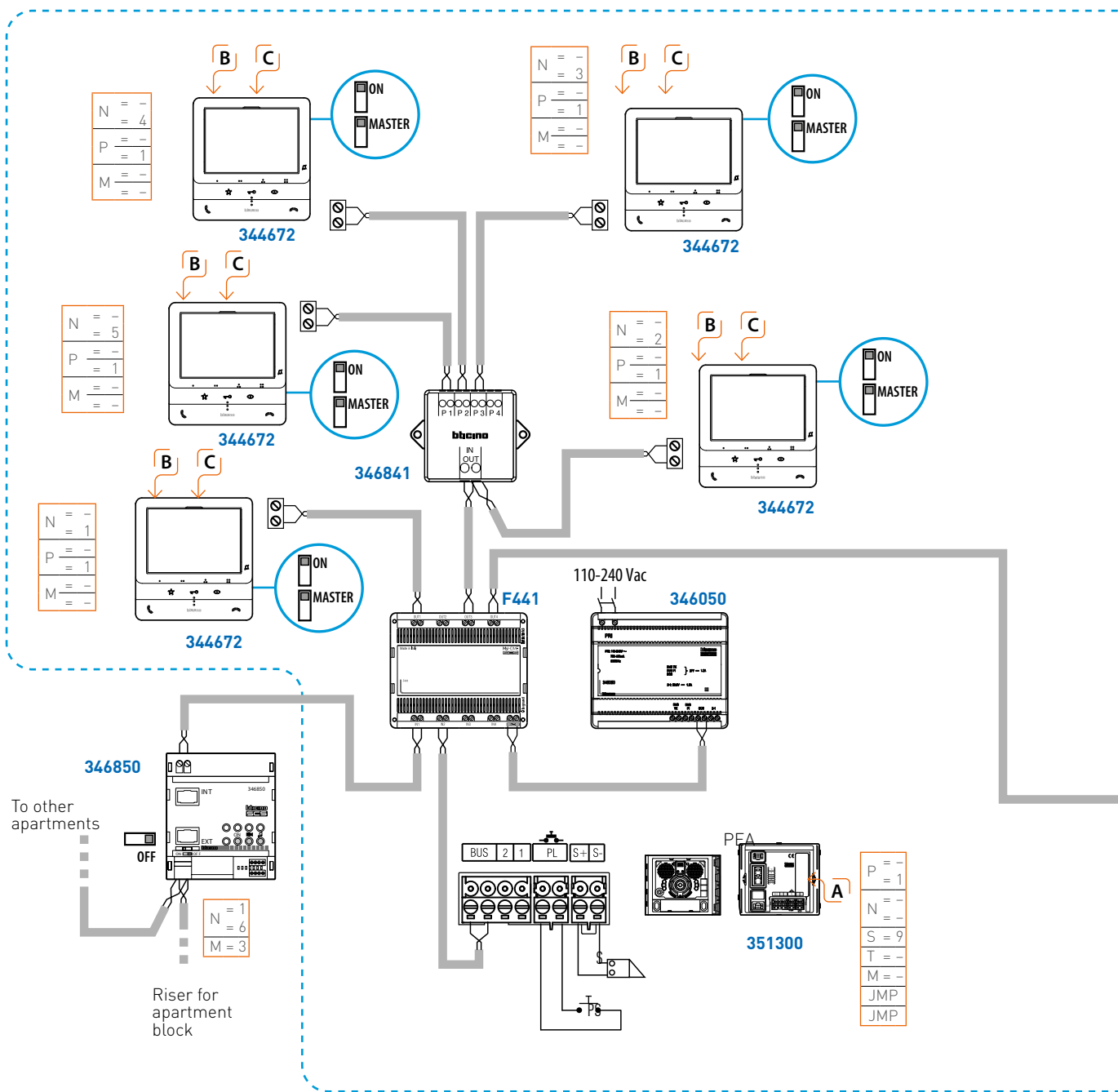

**CAUTION**

- Configure the apartment Entrance Panels from P = 1
- All the IU must be MASTER.

**A** For the realisation of the Entrance Panel, it is possible to use SFERA, LINEA 3000 or LINEA 2000 pushbutton panels. For further information, see the "ENTRANCE PANEL VARIANTS" section.

**B** For the installation of Internal Units other than those indicated in the diagrams, refer to the "INTERNAL UNITS VARIANTS" section.

**C** Move to ON the microswitch on the back of the internal unit that terminates the line.

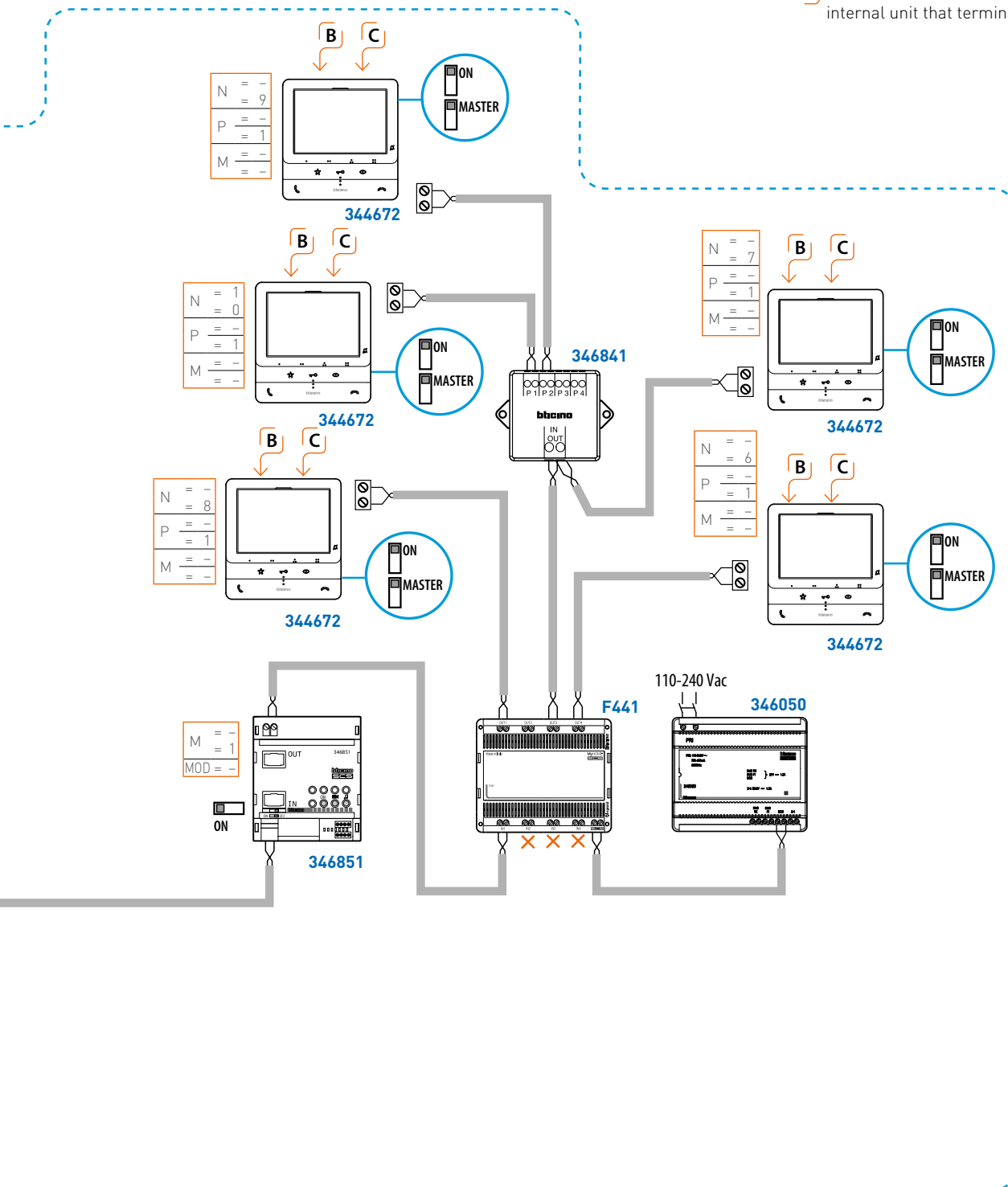

# System with 1 guard station and independent risers

ITEM	DESCRIPTION
346310	Guard station
346020	Additional power supply
F441	Audio video node
346050	Power supply

**⚠ CAUTION**

- An additional power supply with 346020 is recommended
- Use the YouDiagram software for the functional check and calculation of the current absorptions – free download from: [www.professionisti.bticino.it](http://www.professionisti.bticino.it)
- Refer to the documentation supplied with the Guard station for its configuration.

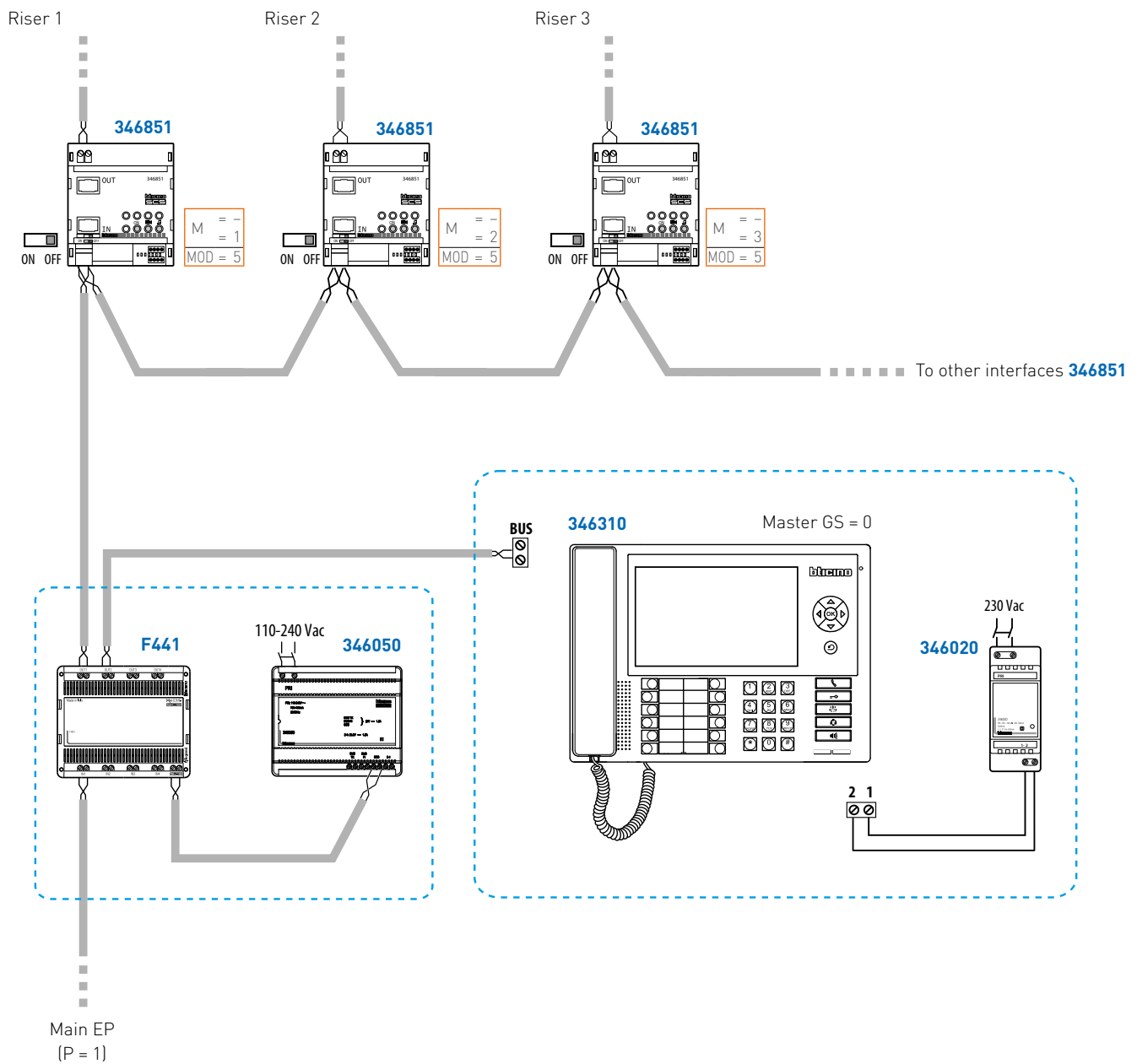

# System with several guard stations and independent risers

ITEM	DESCRIPTION
346310	Guard station
346020	Additional power supply
F441	Audio video node
346050	Power supply

## ⚠ CAUTION

- An additional power supply with 346020 is recommended
- Max. 3 GS which can be star connected with audio video node. Up to a max. of 16 GS can be connected in IN/OUT connection or with floor shunt 346841.
- Refer to the documentation supplied with the Guard station for its configuration

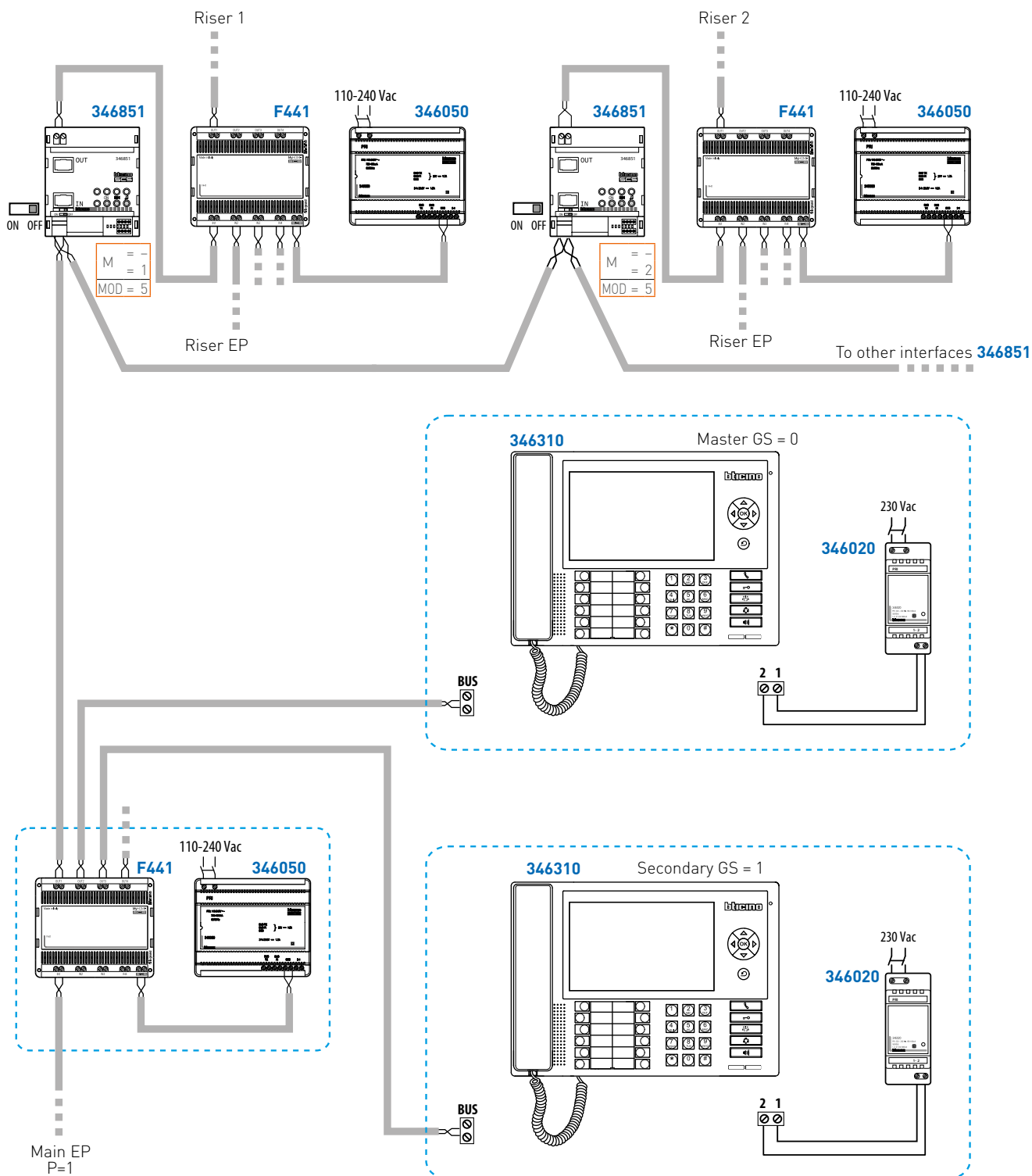

# Hierarchical system with 1 backbone GS and 1 GS for each independent riser

ITEM	DESCRIPTION
346310	Guard station
346020	Additional power supply
F441	Audio video node
346851	System expansion interface
346050	Power supply

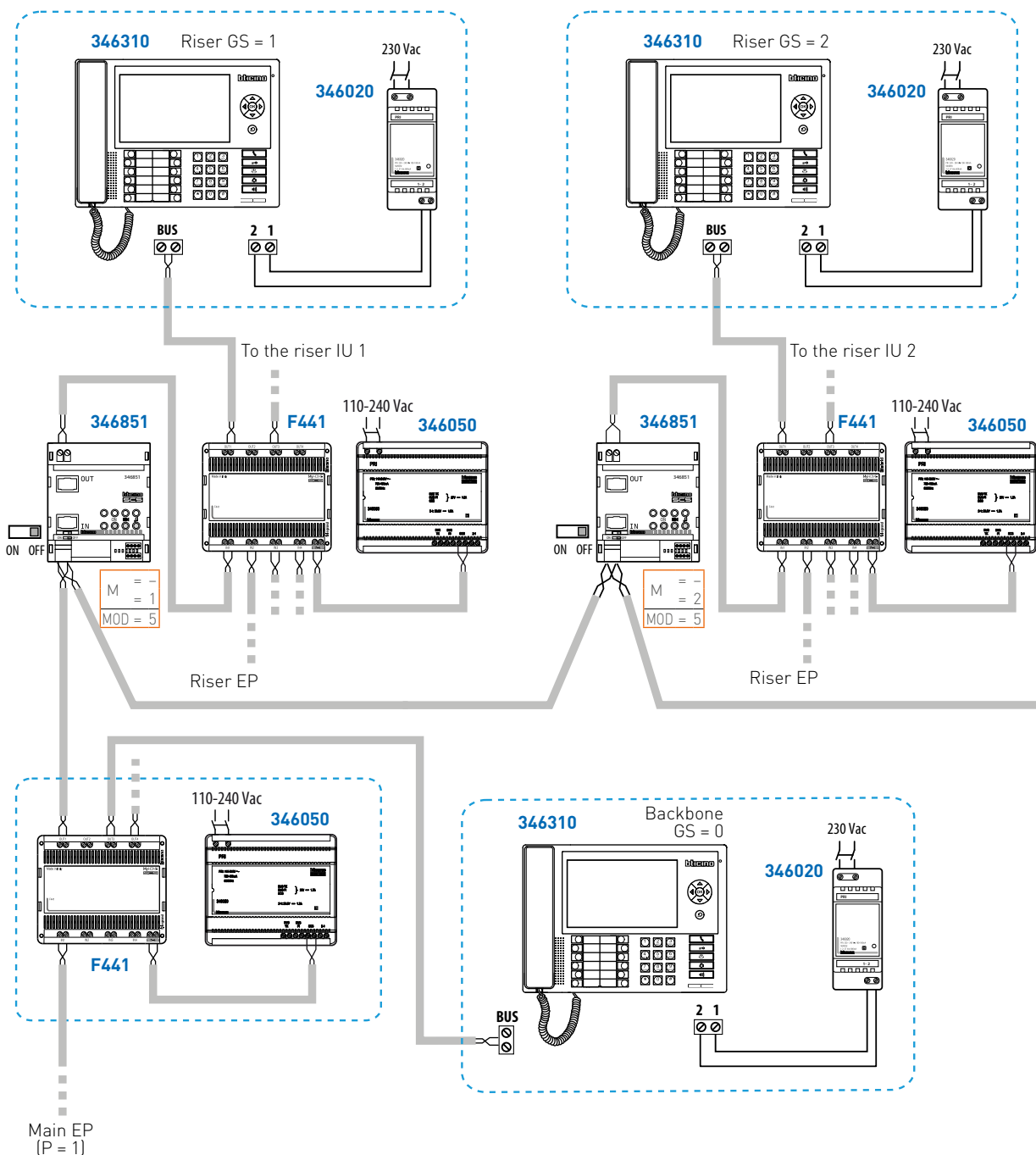

**⚠ CAUTION**

- An additional power supply with 346020 is recommended
- Refer to the documentation supplied with the product for the Guard station configuration and its operation
- The backbone GS do not manage the riser EP video signal
- A maximum of 16 GS can be installed

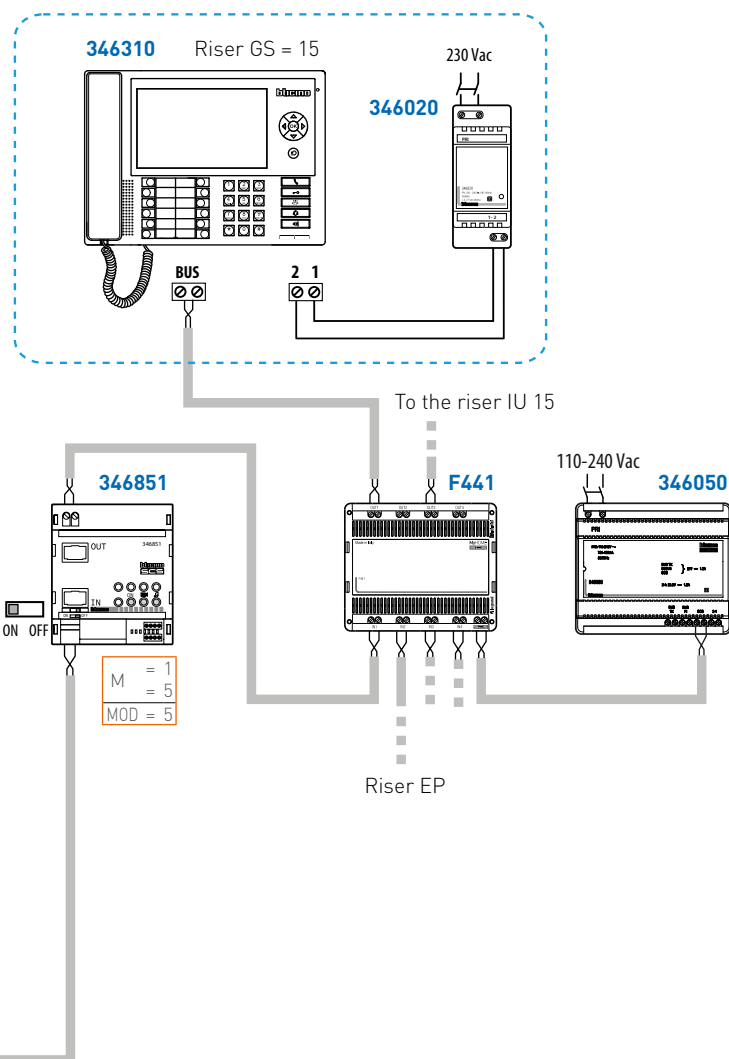

# Hierarchical system with backbone GS, riser GS and Slave GS on the backbone and on the riser

ITEM	DESCRIPTION
346310	Guard station
346020	Additional power supply
F441	Audio video node
346851	System expansion interface
346050	Power supply

**CAUTION**

- An additional power supply with 346020 is recommended
- Refer to the documentation supplied with the product for the Guard station configuration and its operation
- The backbone GS do not manage the riser EP video signal
- A maximum of 16 GS can be installed
- Use the YouDiagram software for the functional check and calculation of the current absorptions – free download from: [www.professionisti.bticino.it](http://www.professionisti.bticino.it)
- The slave GS follow the day/night settings of the associated GS

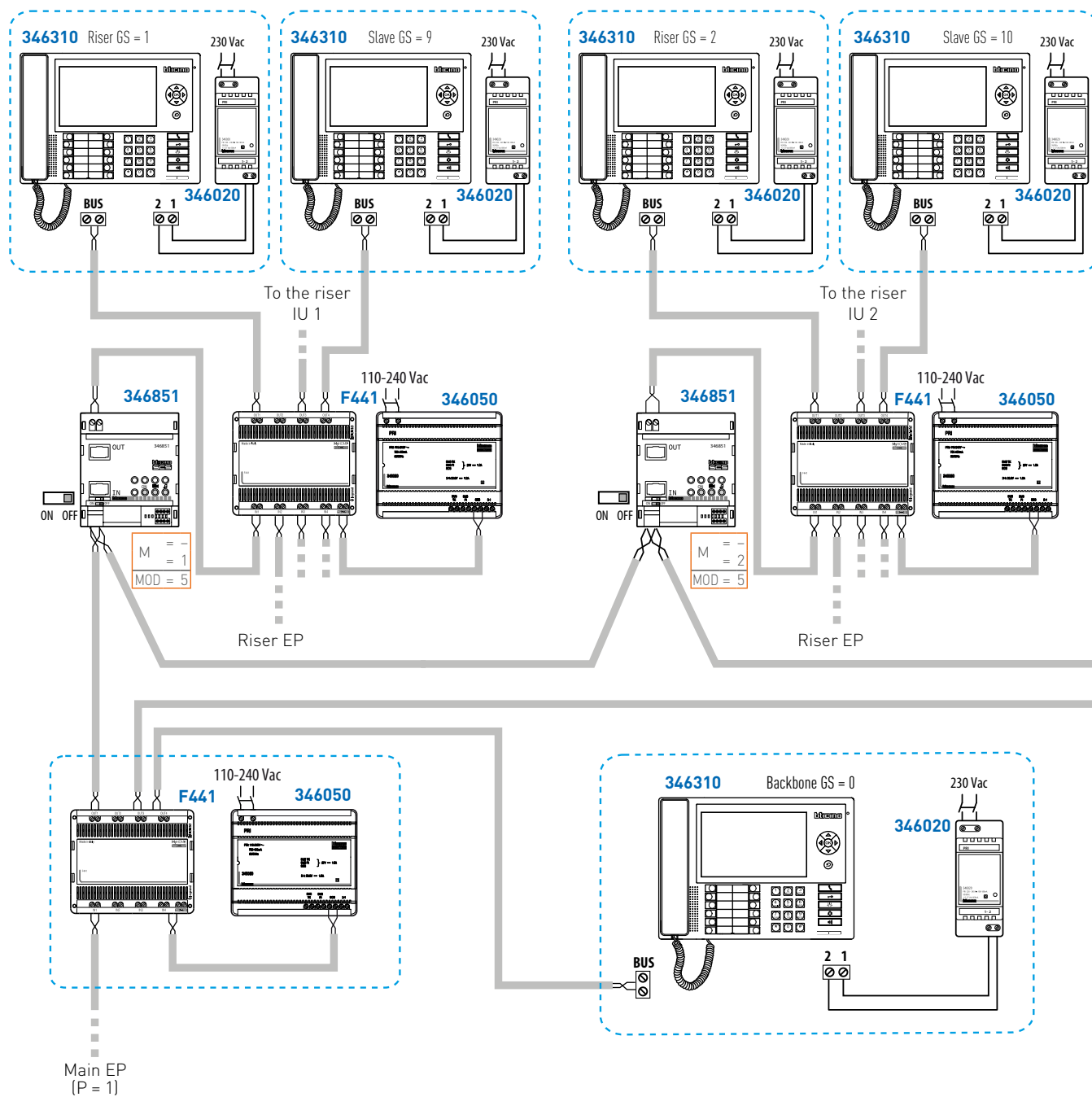



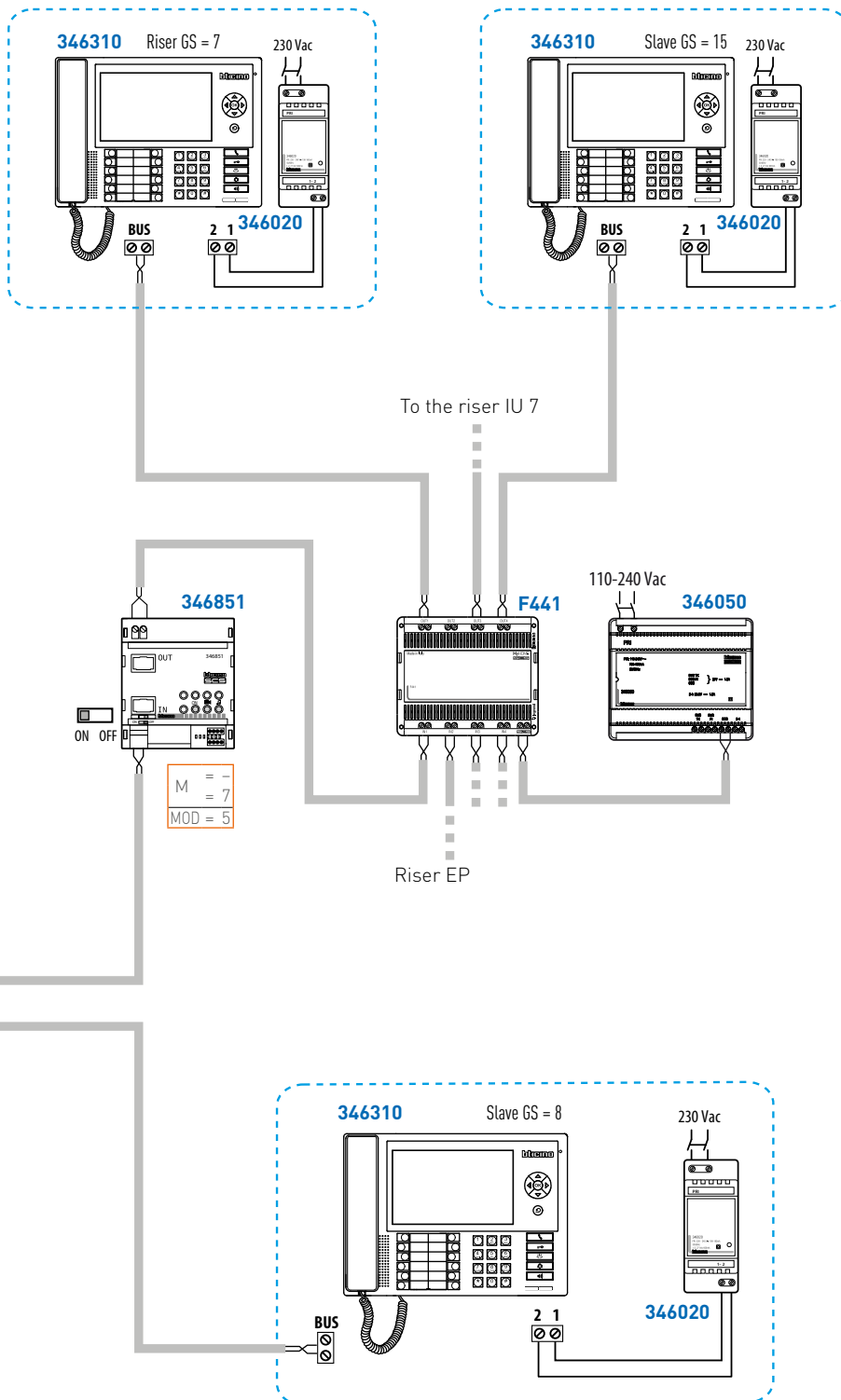

# 2 wire/IP mixed system with guard station software

ITEM	DESCRIPTION	ITEM	DESCRIPTION
351200	SFERA A/V module	346851	System expansion module
352500	SFERA Display Module	346850	Apartment interface
353000	SFERA Keypad Module	F441	Audio video node
344672	CLASSE 100 V16E video internal unit	346841	Floor shunt
346300	Guard station software	347400	Coax -2 WIRES interface
346050	Power supply	346891	2 WIRES - IP interface
346020	Additional power supply	3499	Line terminators

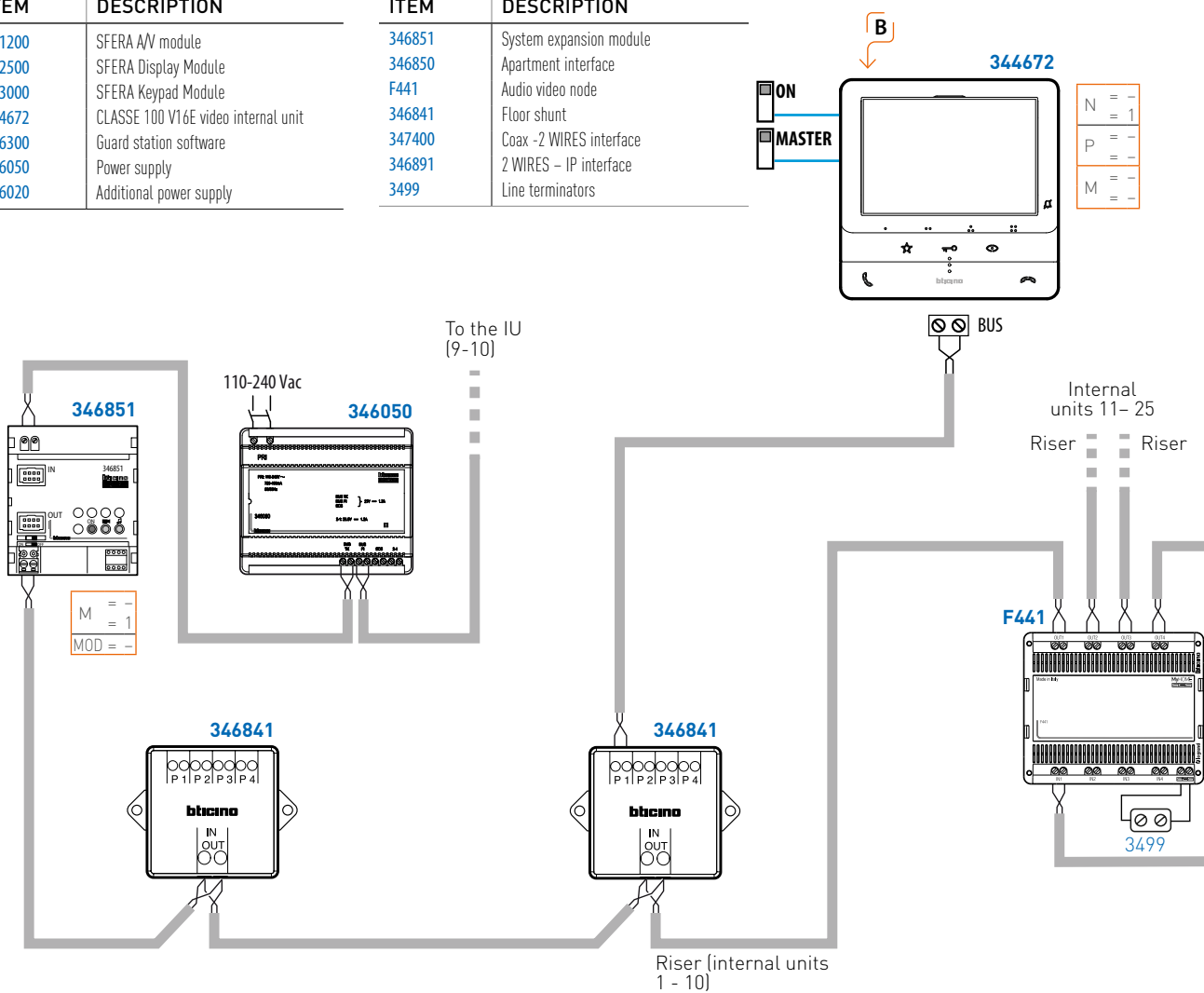

Software  
Guard station (346300)



← LAN

- Configuration using the SwitchBoardConfigurator software
- The LAN network must be dedicated to the IP video door entry service

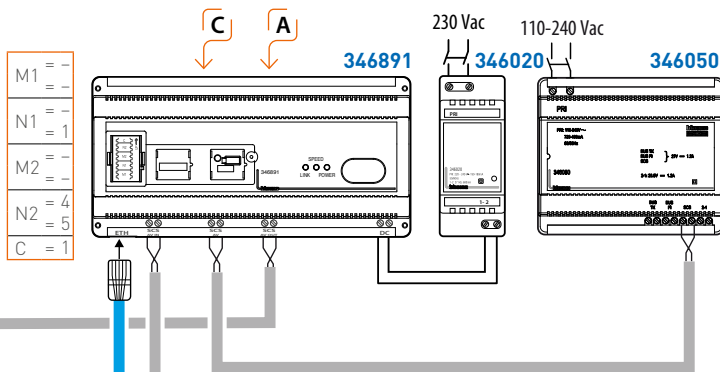
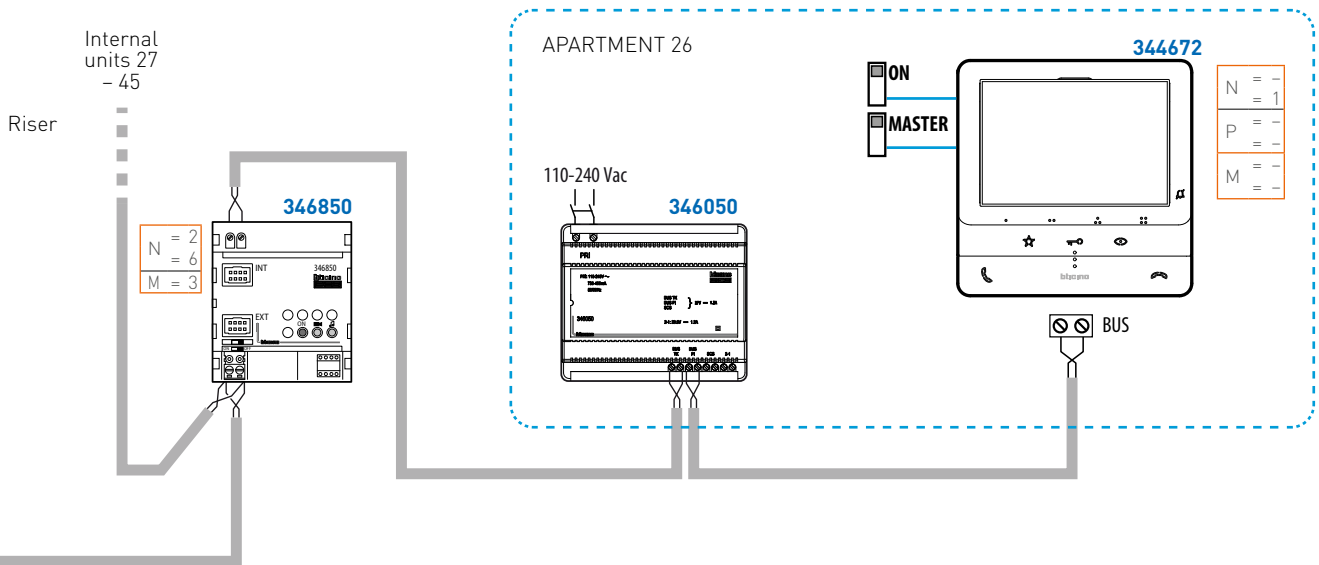

**A** Device also configurable using **MyHomeSuite**, which can be downloaded from: [www.homesystems-legrandgroup.com](http://www.homesystems-legrandgroup.com)

**B** For better image quality, it is recommended to use video internal units with display size <7".

**Caution:** the interface is NOT compatible with Classe 300EOS and HOMETOUCH internal units. ONLY use in systems with Classe 100 internal units.

**C**

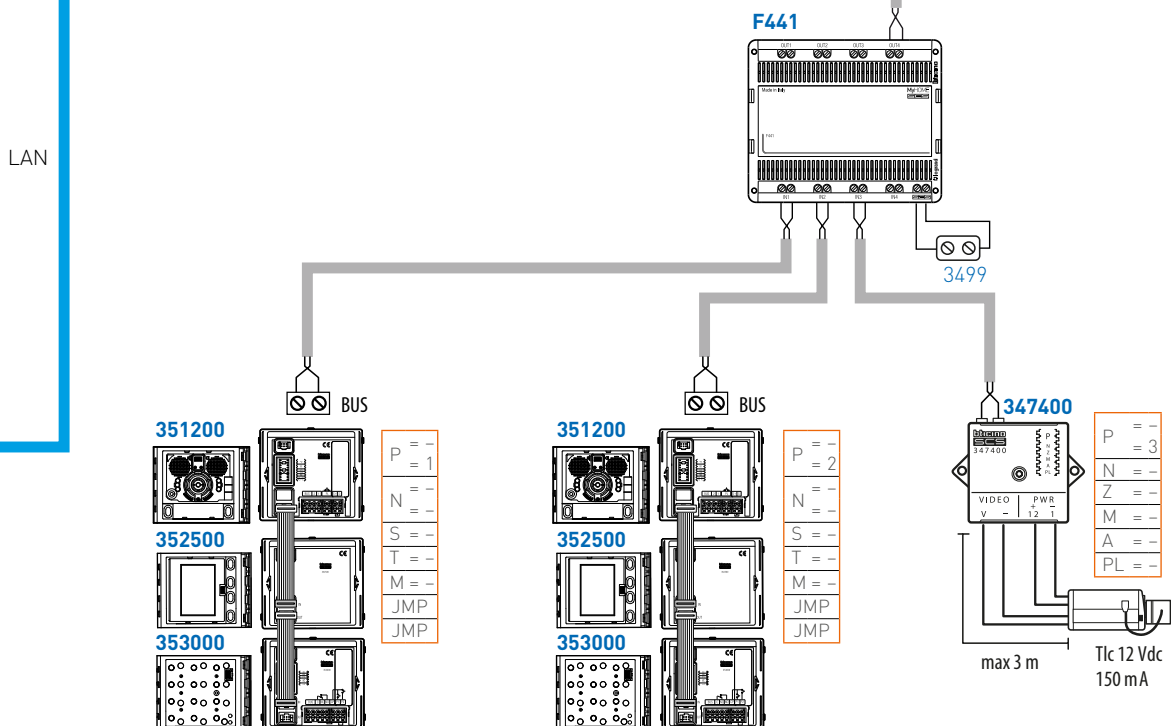

# Residential complex with 2 wire/IP mixed system

ITEM	DESCRIPTION
351200	SFERA A/V module
352500	SFERA Display Module
353000	SFERA Keypad Module
346050	Power supply
PEP	Main Entrance Panel
PEM	Riser Entrance Panel

ITEM	DESCRIPTION
346020	Additional power supply
346851	System expansion interface
346300	Guard station software
346891	2 WIRES - IP interface

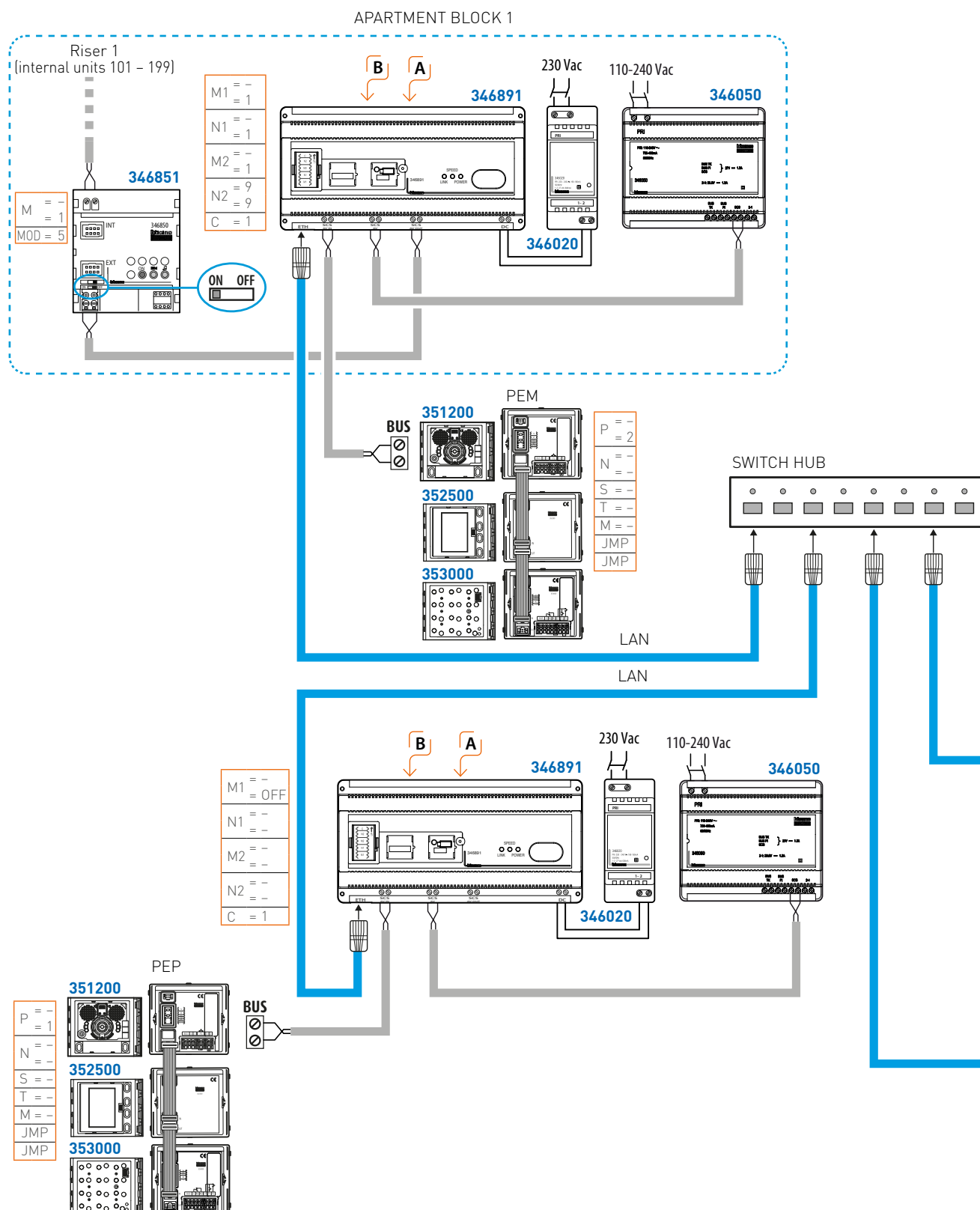

APARTMENT BLOCK 2

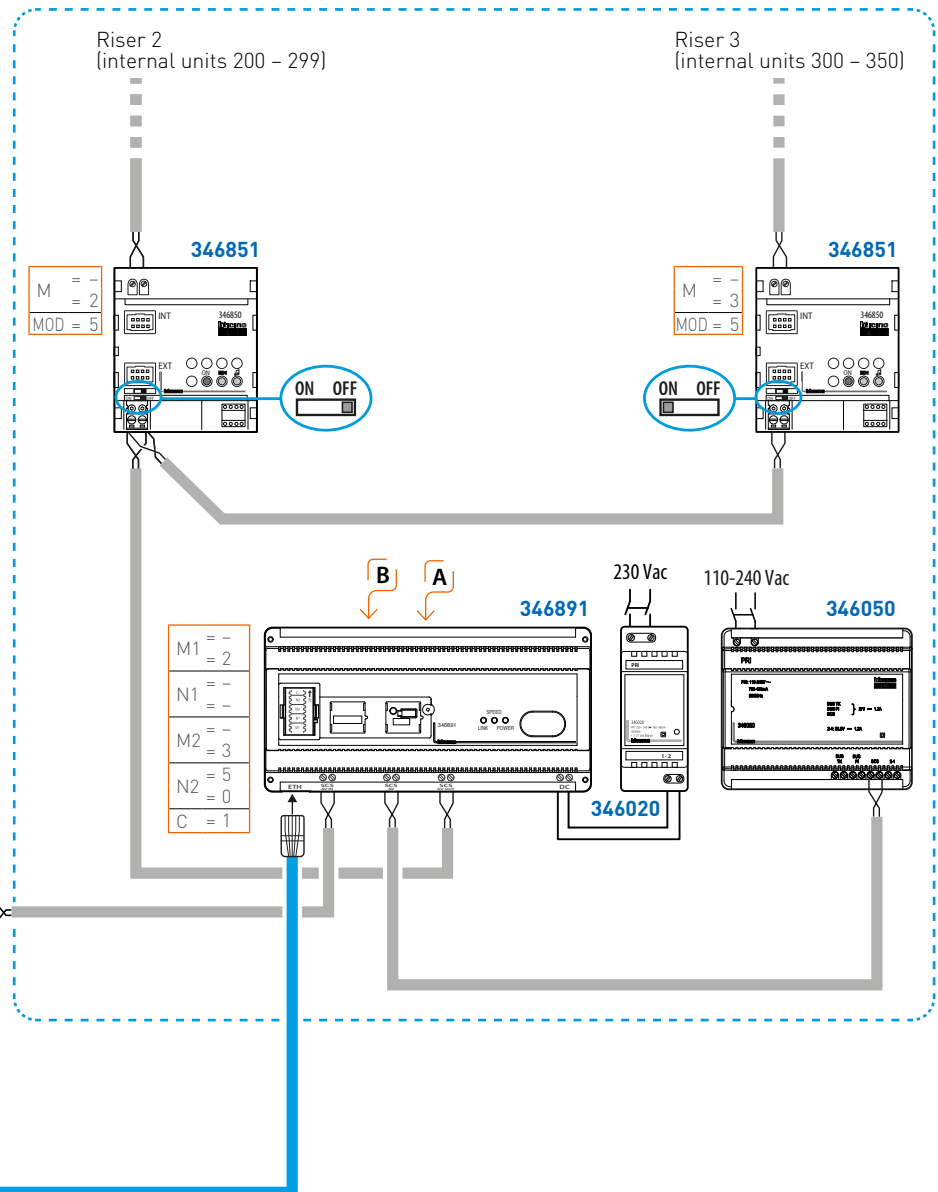

- A** Device also configurable using **MyHomeSuite**, which can be downloaded from: [www.homesystems-legrandgroup.com](http://www.homesystems-legrandgroup.com)

**B** **Caution:** the interface is NOT compatible with Classe 300EOS and HOMETOUCH internal units. ONLY use in systems with Classe 100 internal units.

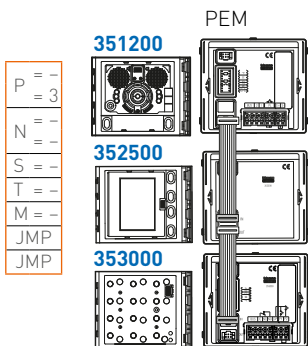

LAN

Guard station (346300) software



- Configuration using the SwitchBoardConfigurator software
- The LAN network must be dedicated to the IP video door entry service

LAN

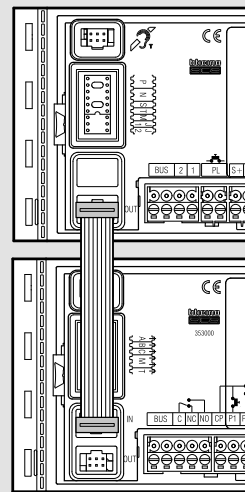
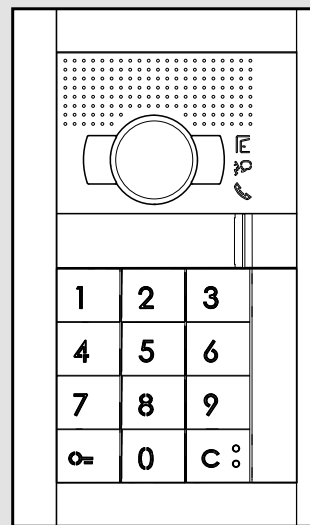
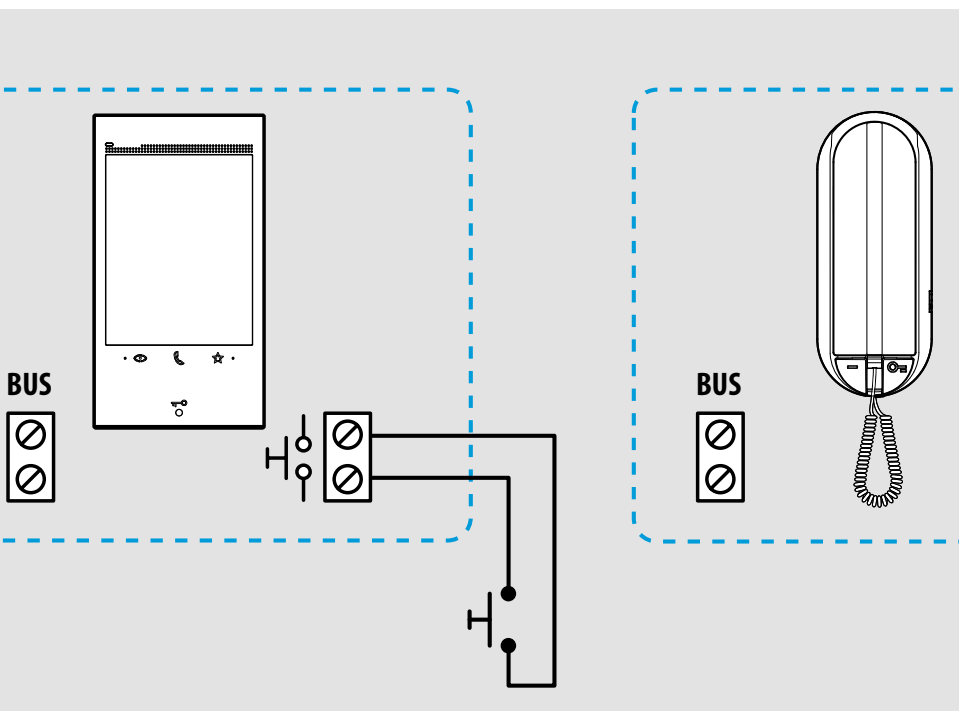

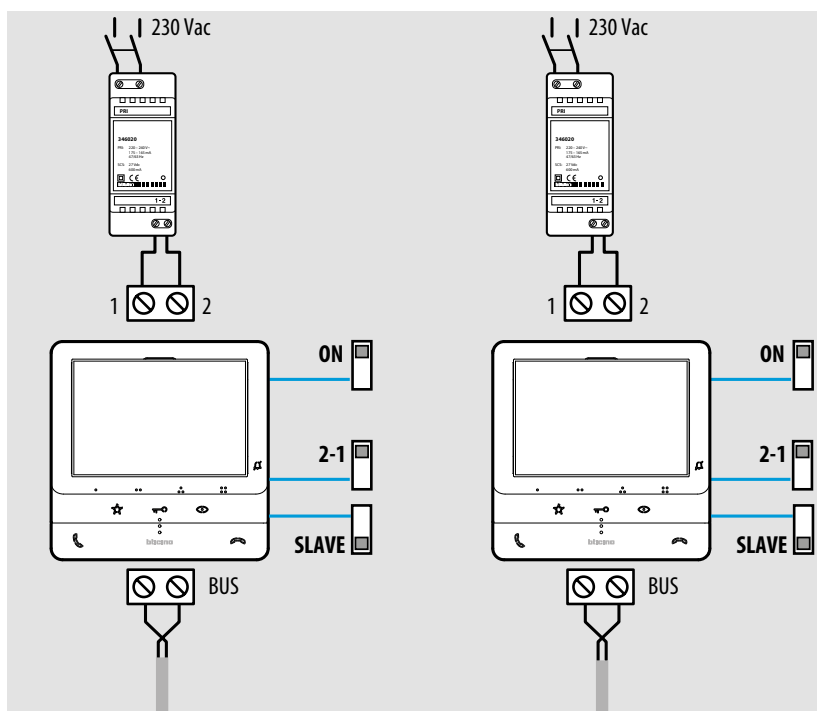
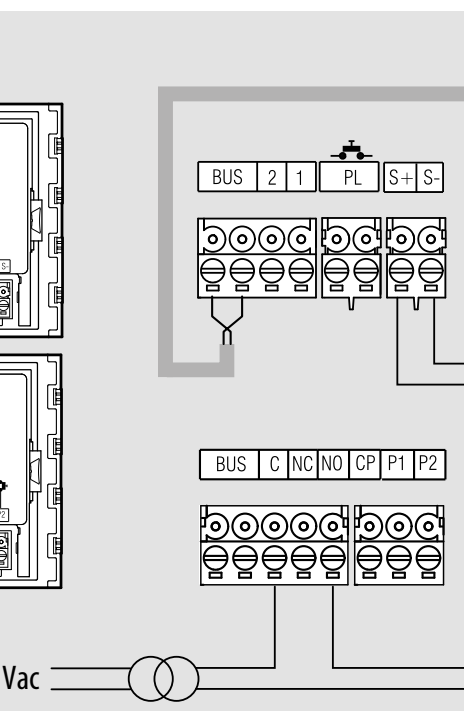

# 3.1 WIRING DIAGRAMS VARIANTS

## SFERA entrance panels

Thanks to their flexibility, SFERA entrance panel offer countless installation combination. As it is impossible to present all such possible combination, below are some simple rules that must be complied with for the combination of the electronic modules.

For the composition of the entrance panel, always start from the speaker module and/or the audio/video module:

Basic speaker module **351000**

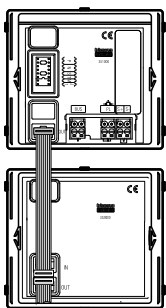

To the BASIC speaker module **351000** it is ONLY possible to connect **pushbutton modules 352000/352100** either in all pushbuttons on single column, or all pushbuttons on double column mode – a mixed solution is NOT permitted.

Pushbutton module **352000**  
**352100**

Teleloop module **352700**



Speaker module **351100**

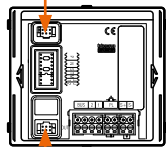

To the speaker modules **351100**, **351200** and **351300**, it is possible to connect (through dedicated connection) the Teleloop Module and control voice synthesis **352700**. To the audio module **351100** it is possible to connect an N/D and wide angle lens camera module **352400**.

(Caution: **352700** e **352400** max. 1 for entrance panel).

Camera module **352400**

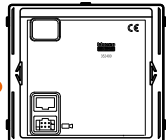

A/V module **351200**  
**351300**

1

Display module **352500**



All the other electronic modules must be connected following this connection order:

1. Display module **352500** (ONLY 1 for entrance panel)
2. Door lock release modules (keypad **353000** and key card reader **353200**)  
- always after the keypad module (if present).
3. Pushbutton modules **352000/352100**

2

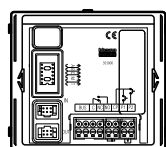

Keypad module **353000**

Key card reader module **353200**

### NOTES:

- The use of the display module **352500** prevents the installation of pushbutton modules **352000/352100** and vice versa.
- Plate module **352200** may be installed without particular limitations (with the exception of the reaching of the system absorption limits), in combination with display module **352500** and/or door lock release modules.
- Door lock release modules: keypad **353000** and badge reader **353200**, must ONLY be 1 of each type on the same pushbutton panel, if connected using flat cable.
- Door lock release modules: keypad **353000** and badge reader **353200**, may be used individually and/or simultaneously in STAND ALONE installations.

3



Pushbutton module **352000**  
**352100**



# Wiring diagrams variants of Entrance Panels/Cameras

## SFERA ENTRANCE PANELS IN AUDIO SYSTEMS

### Installation in audio systems with power supply 346040

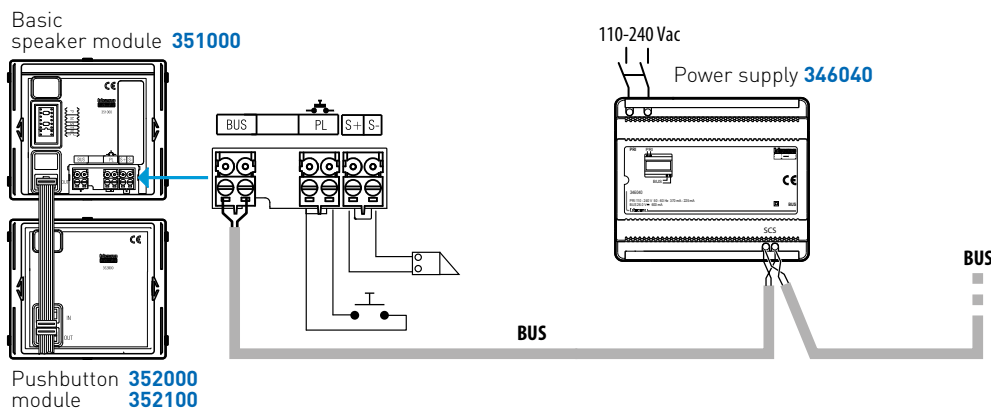

NOTE: it is possible to install other pushbutton modules 352000/352100 complying with the installation rules for SFERA Entrance Panels.

### Installation in audio systems with power supply 346050

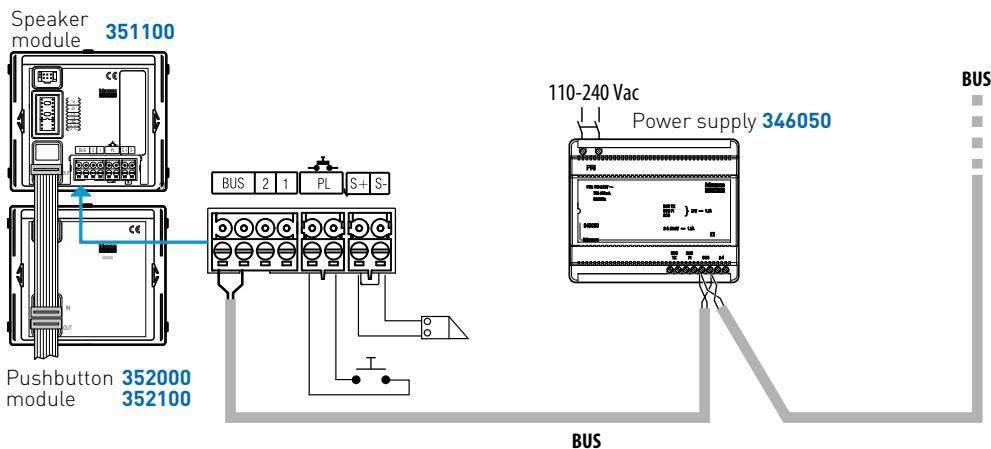

NOTE: it is possible to install other pushbutton modules 352000/352100 complying with the installation rules for SFERA Entrance Panels.

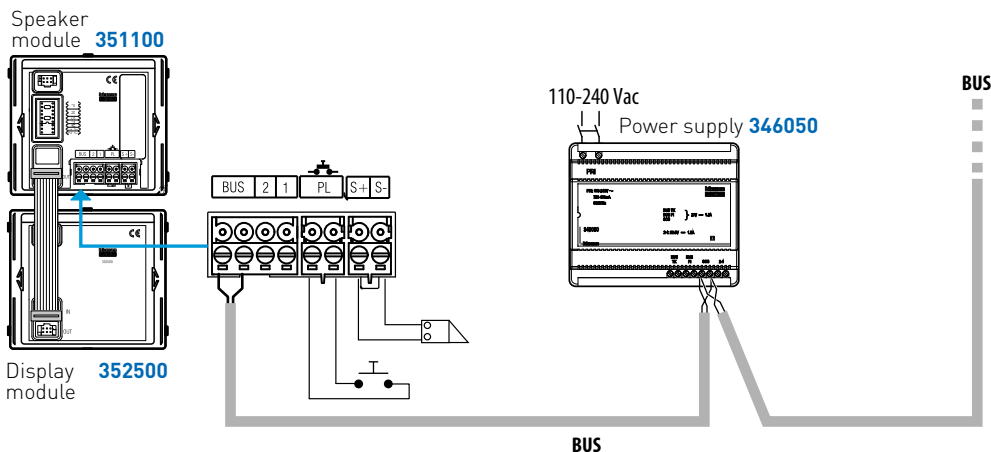

NOTE: The residents' address book of Display module 352500 can be inserted manually, or using a PC and the TiSferaDesign software, and then uploaded to the module using a USB interface (recommended).

# Wiring diagrams variants of Entrance Panels/Cameras

## SFERA ENTRANCE PANELS IN VIDEO SYSTEMS

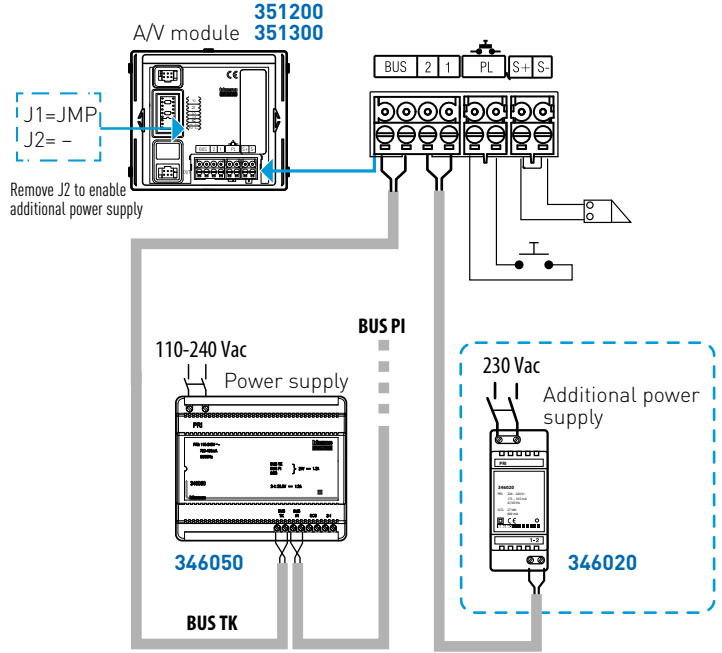
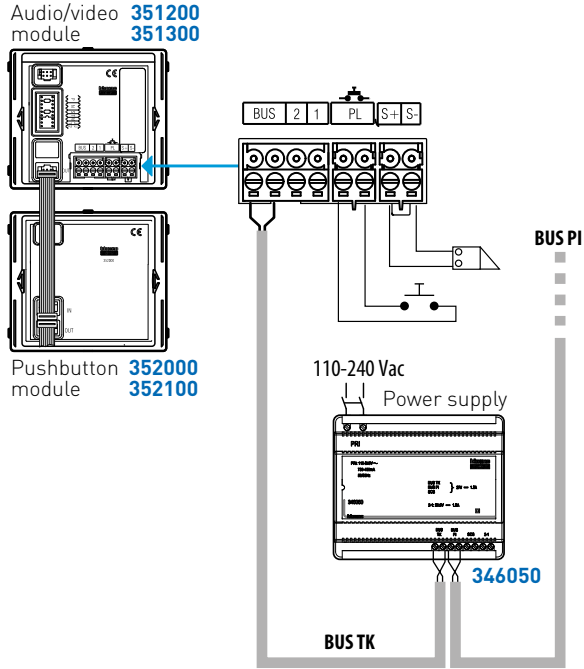

**NOTE:** In systems with several Internal Units, it will be necessary to allow for an extra power supply to be connected to the speaker module of the Entrance Panel. In order to connect the additional power supply unit, it will be necessary to remove configurator J2 from the speaker module.

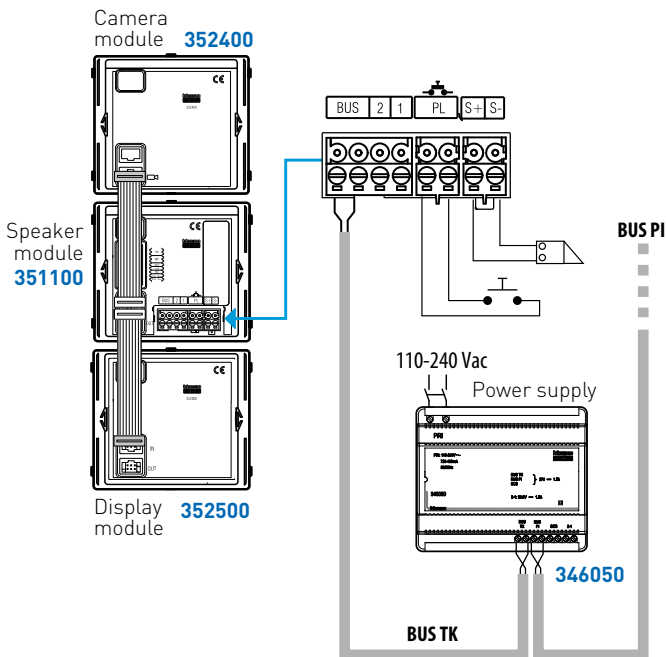

**NOTE:** The residents' address book of Display module 352500 can be inserted manually in the device, or using a PC and the TiSferaDesign software, and then uploaded to the module using a USB interface (recommended).

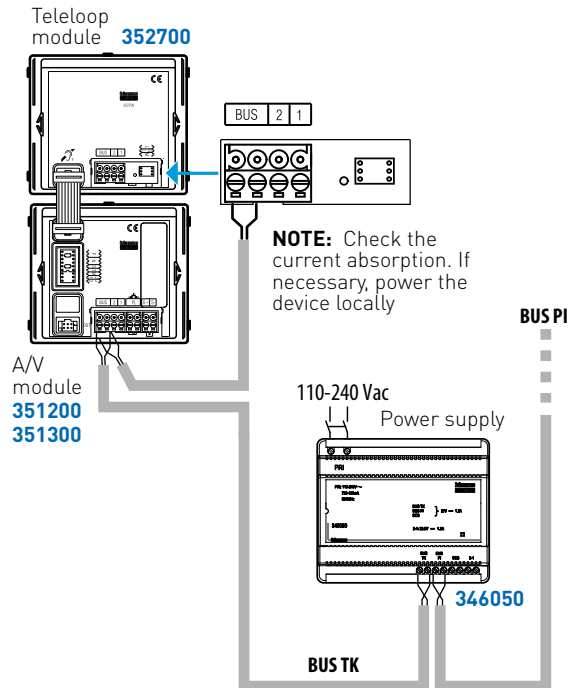

**NOTE:** Teleloop module 352700 may be connected directly to speaker module 351100 and to A/V modules 351200/351300.

**SFERA ENTRANCE PANELS IN AUDIO AND VIDEO SYSTEMS**

**Connection to the key expansion module 346993**

Wiring with separate commons

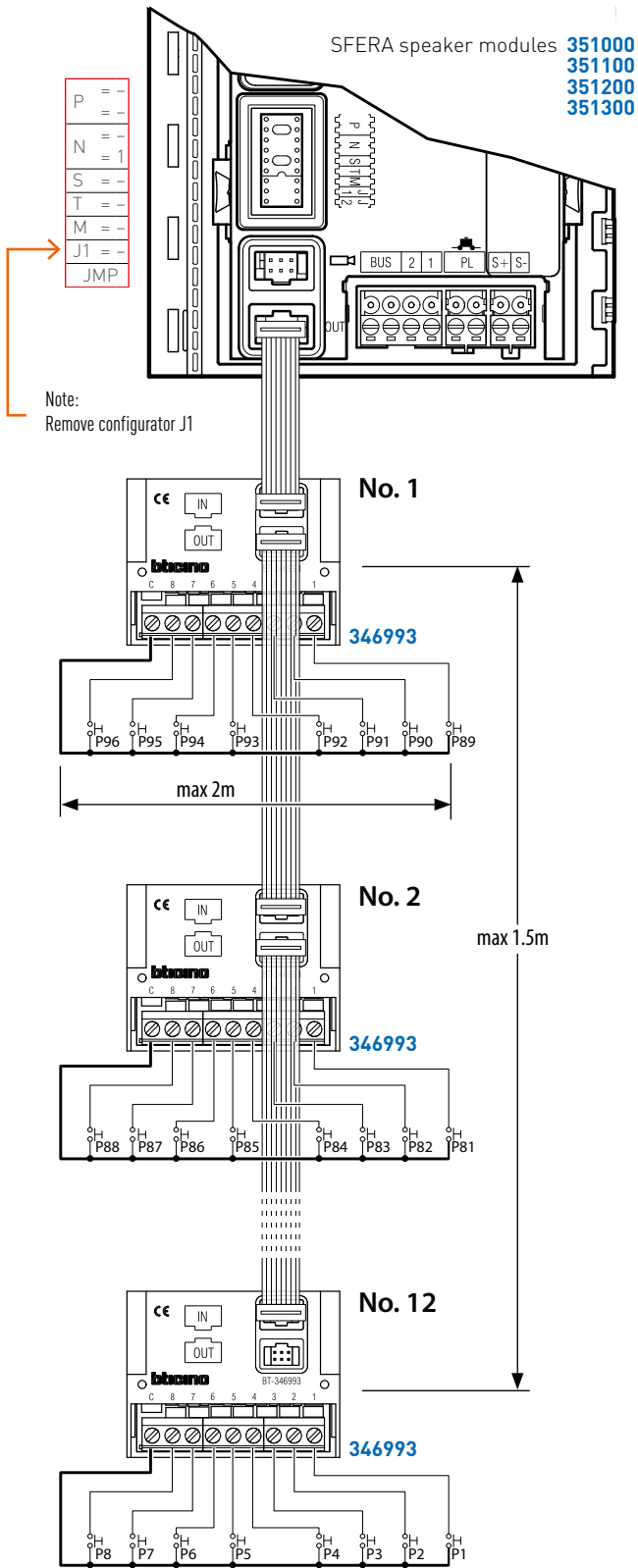

Wiring with unique common

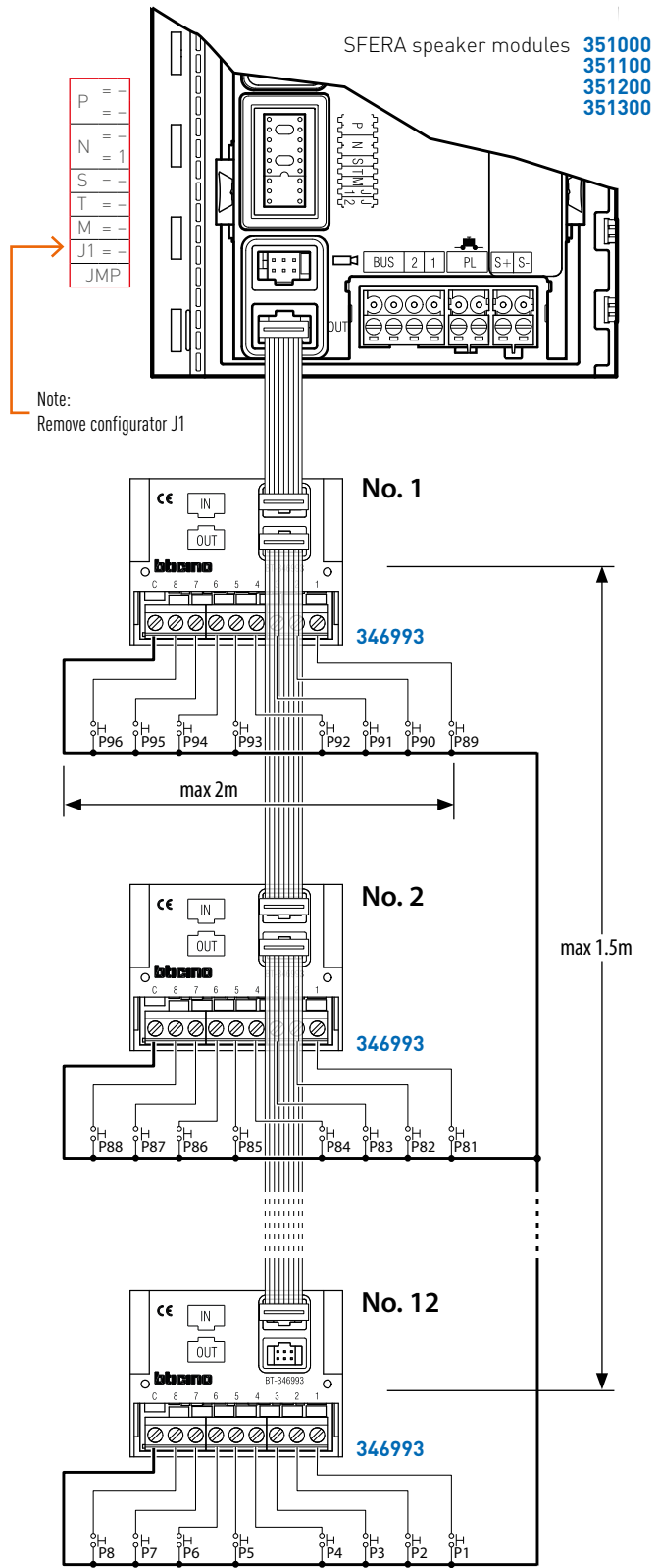

Each module 346993 can manage up to 8 call keys. It is possible to connect several modules 346993 (Max. 96 call keys for each Entrance Panel).

# Wiring diagrams variants of Entrance Panels/Cameras

## LINEA 300 ENTRANCE PANELS IN VIDEO SYSTEMS

### Systems with LINEA 300 pushbutton panel

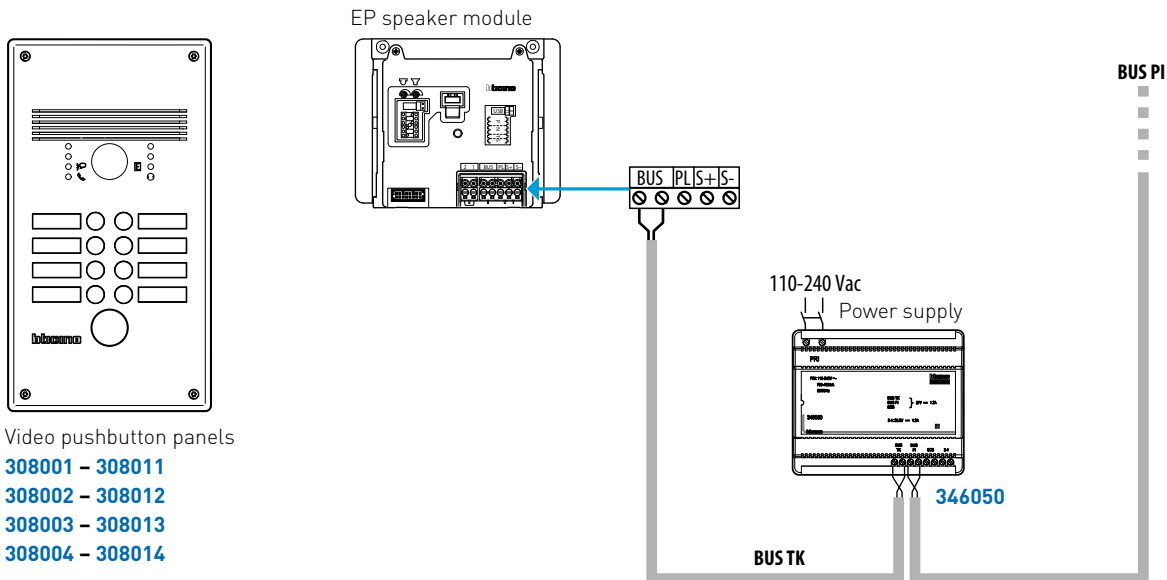

### Systems with LINEA 300 pushbutton panel and additional power supply

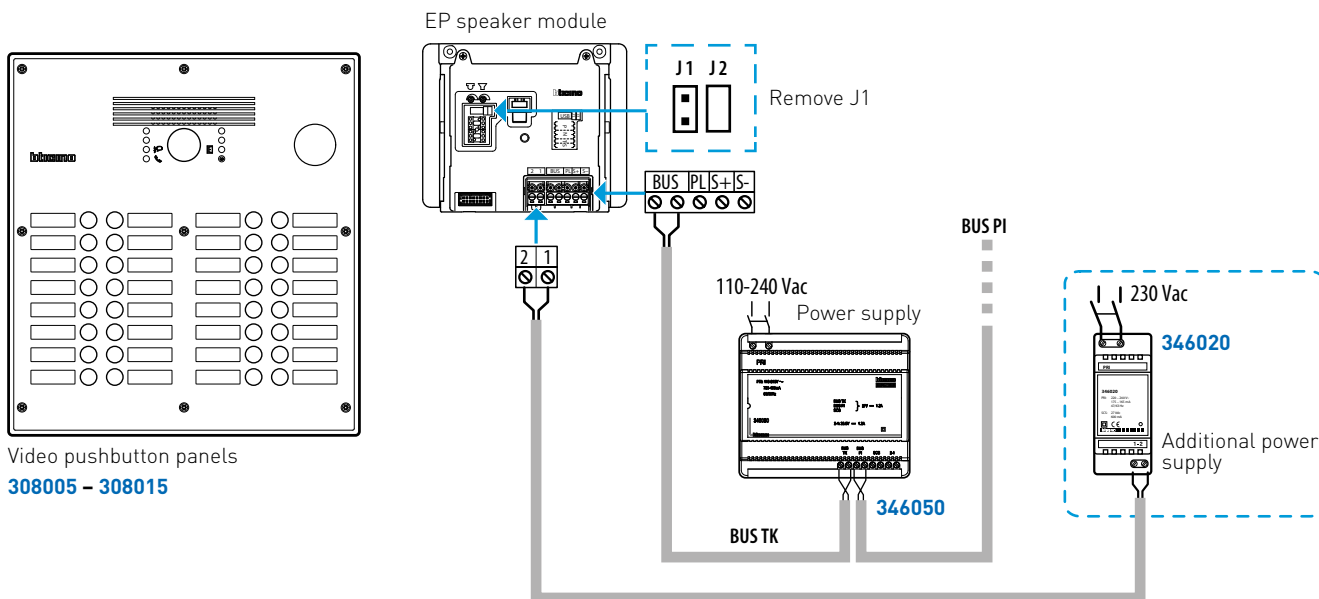

**NOTE:** in systems with several Internal Units, it will be necessary to allow for an extra power supply to be connected to the speaker module of the Entrance Panel. Before connecting the additional power supply, it will be necessary to remove **jumper J1** from the speaker module.

**LINEA 2000 ENTRANCE PANEL**

LINEA 2000 Entrance Panels for installation in audio system (up to 4 calls)

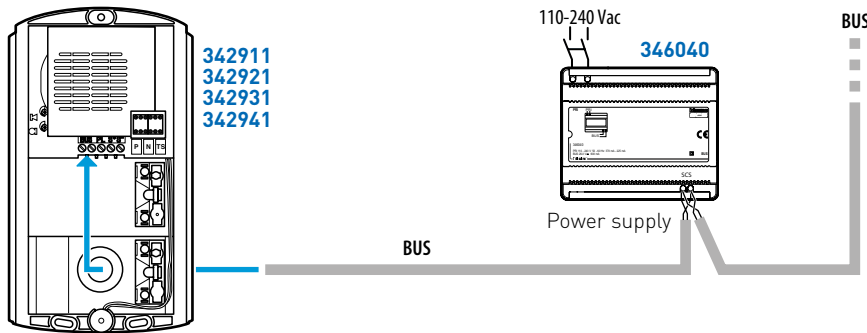

LINEA 2000 Entrance Panels for installation in video one and two family systems

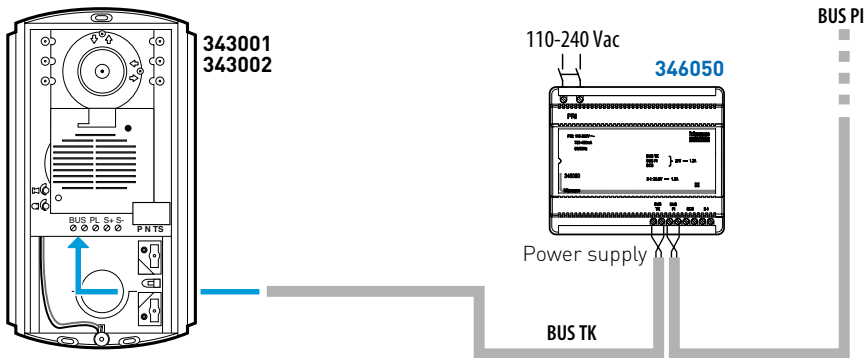

NOTE: the LINEA 2000 Entrance Panels cannot be powered locally.

**LINEA 3000 ENTRANCE PANEL**

LINEA 3000 Entrance Panels for installation in audio one and two family systems

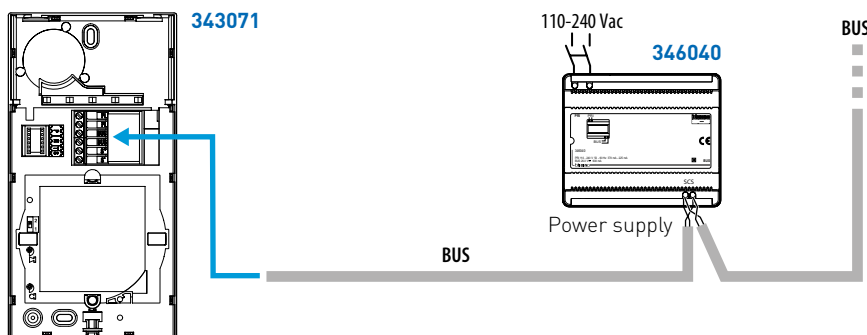

LINEA 3000 Entrance Panels for installation in video one and two family systems

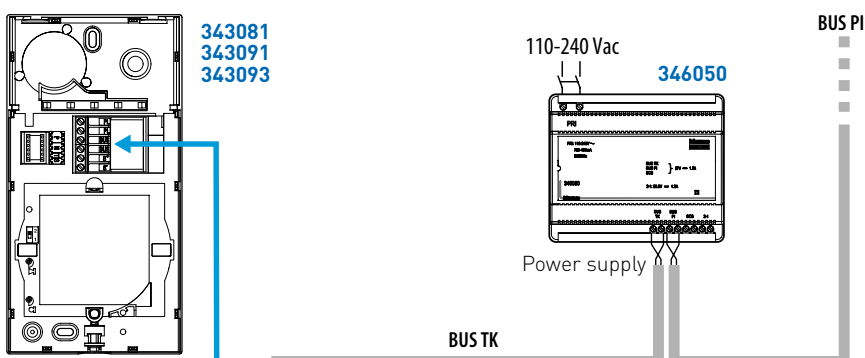

NOTE: the LINEA 3000 Entrance Panels cannot be powered locally.

# Wiring diagrams variants of Entrance Panels/Cameras

## COAXIAL/2 WIRES INTERFACE MODULE 347400

In the connection diagrams, in alternative to SFERA video Entrance Panels, it is also possible to use the coaxial 2 WIRES interface for 12 Vdc cameras, with the corresponding camera. The camera may be connected to the system and associated to the speaker module (separate), or as independent camera. In the system, the coaxial/2 WIRES interface (347400) is considered as a video Entrance Panel.

### Separate camera with in-out wiring to the SFERA speaker module 351100

(\*) Interface 347400 (used for the connection of the separate camera), and the corresponding speaker module, must be configured with the same value in P.

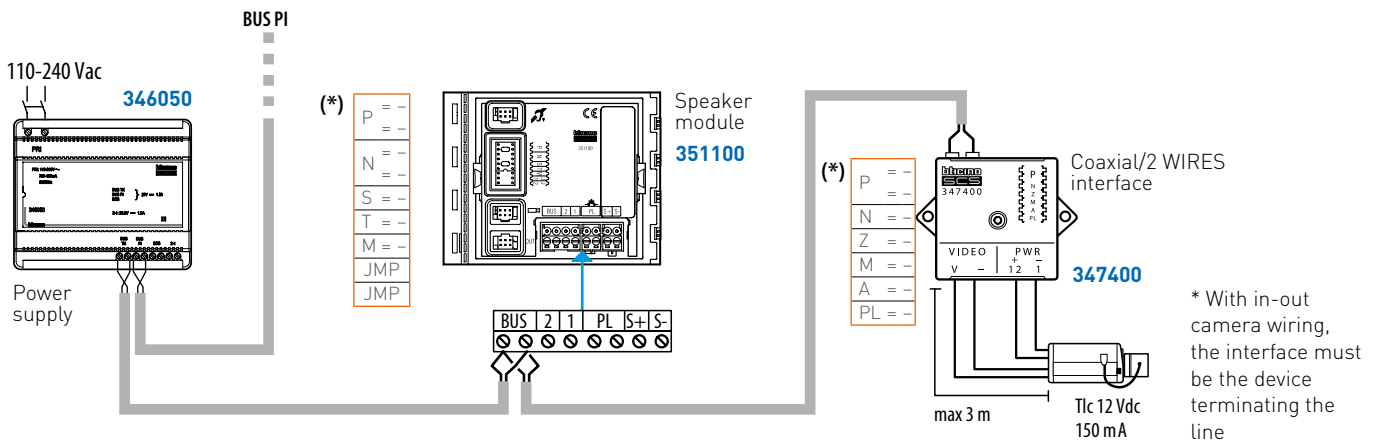

**NOTE:** the Entrance Panel created in this way (speaker module 351100 and separate camera), must be considered as a video Entrance Panel, both for the number of risers that can be connected and the number of Internal Units

### Video Entrance Panel and audio Entrance Panel with separate coaxial camera

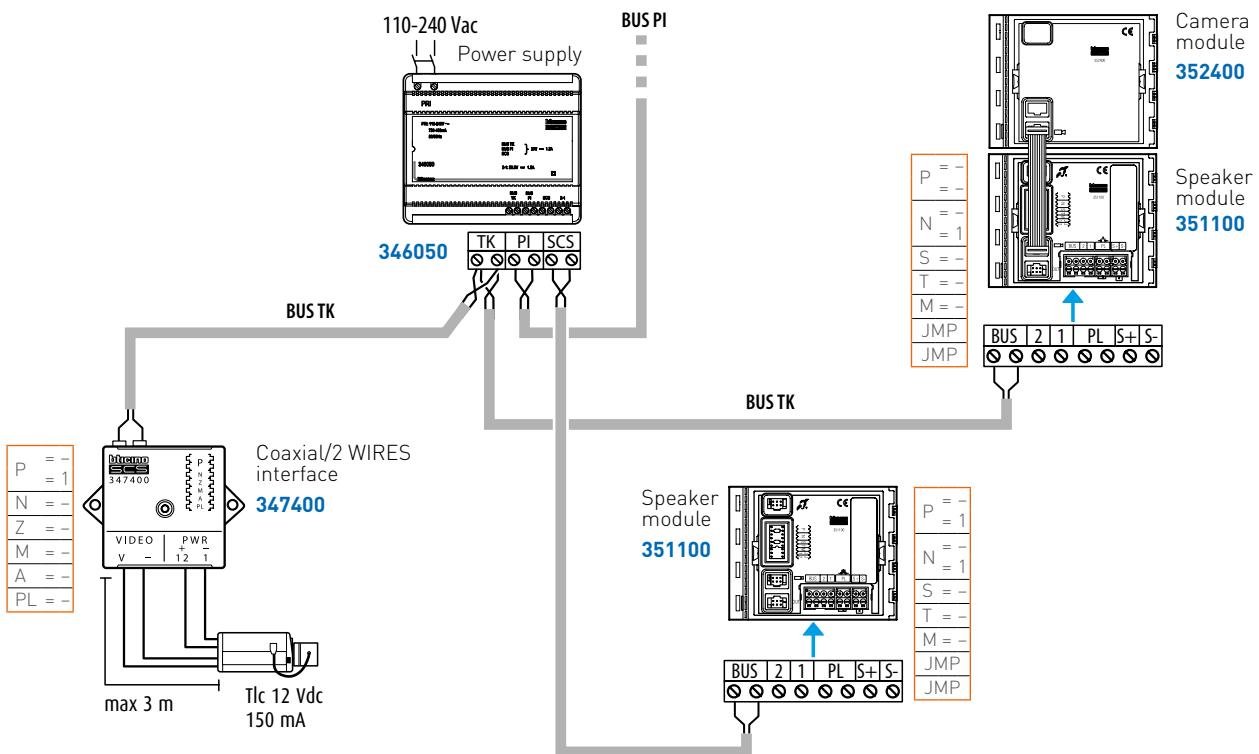

**NOTE:** the camera must be considered as a video Entrance Panel, both for the number of risers that can be connected and the number of Internal Units.

**ACTIVATION OF A LOAD UPON SWITCHING ON OF A CAMERA**

Operating mode of the camera upon switching on of systems integrated with Home automation. Every time that the camera switches on (call, auto-switching on, alarm), the home-automation actuator and the scenario configured in A and PL are activated. When the camera switches off, the associated actuator also switches off, while the scenario remains active. If an actuator used by the automation system is also associated to the camera, the actuator switches off when the camera is switched off, even if when the camera was switched on it was already on. To avoid this, to activate the load use an F411U2, configuring different PLs and connecting the contacts in parallel.

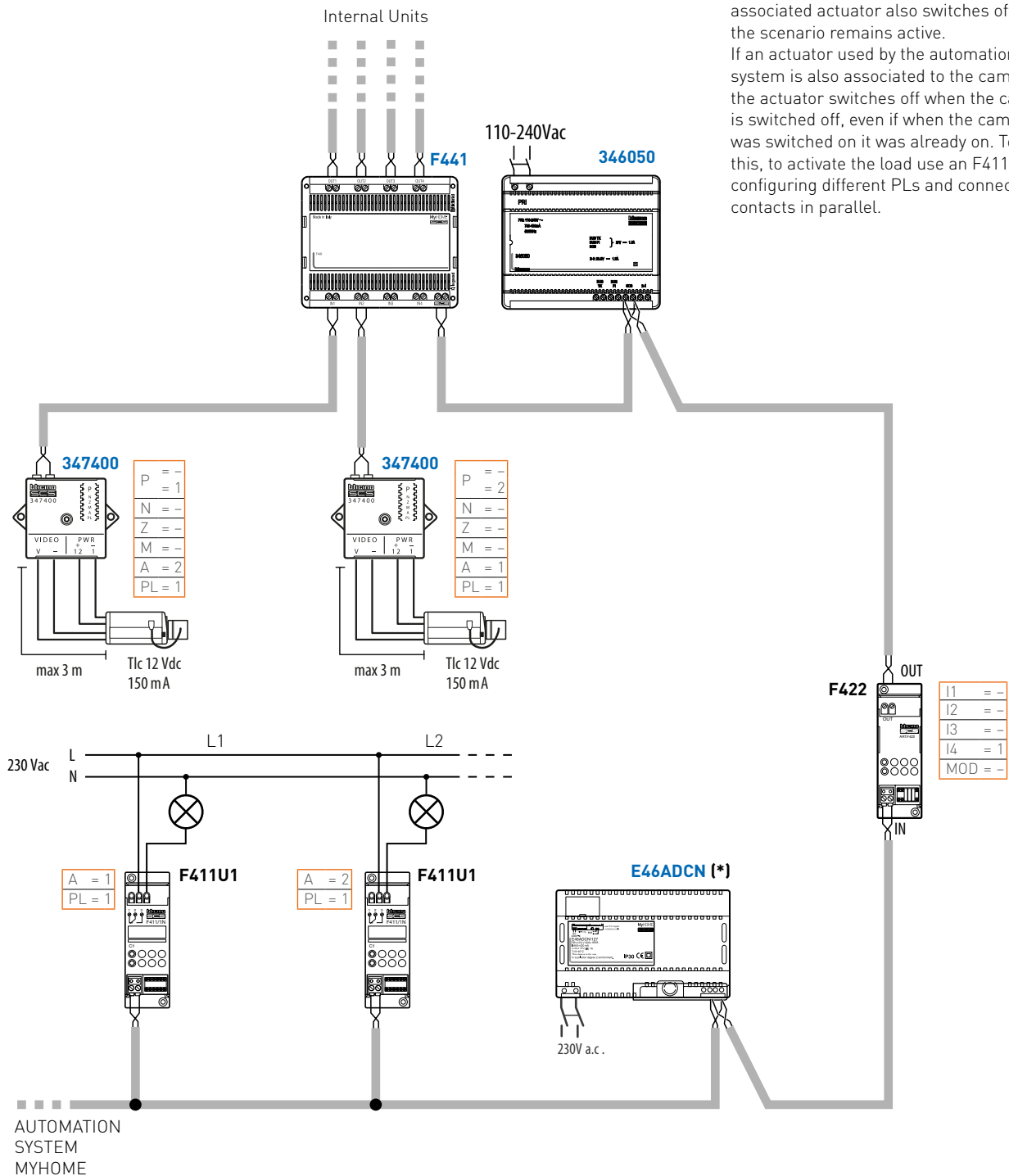

**CAUTION (\*):** during 2022 the E46ADCN power supply will be replaced by the new E56 power supply.

# Internal Unit Variants - Single family or multifamily systems with apartment interface 346850

## EXAMPLE - 4 VIDEO INTERNAL UNITS WITH SIMULTANEOUS SWITCHING ON

**⚠ CAUTION**

To install video internal units with simultaneous switching on, it will be necessary to allow for an output of the floor shunt for each IU

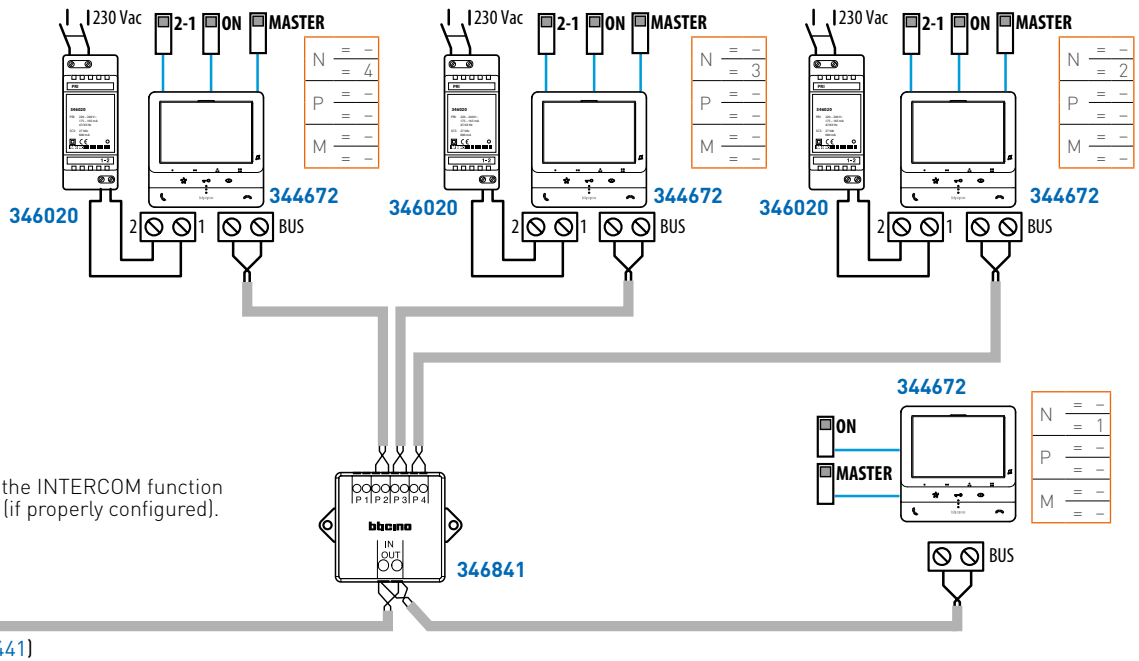

## ESEMPIO - VIDEO INTERNAL UNIT TABLETOP INSTALLATION

**⚠ CAUTION**

**A** In order to install a tabletop video internal unit, it will be necessary to use the audio/video node [F441] or the 346841 floor shunt, dedicating an output to the installation itself.

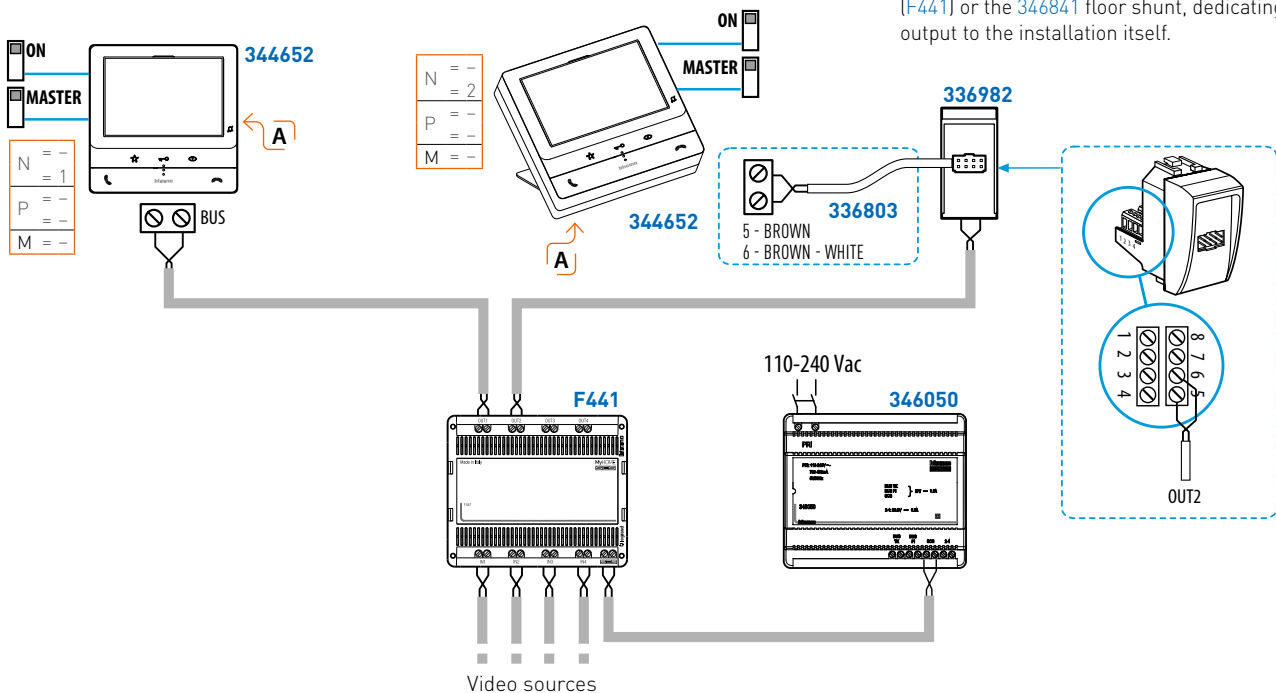



# Internal Unit Variants - Multifamily systems without apartment interface 346850

## ⚠ CAUTION

In the same apartment on the same call, it is possible to install up to 3 devices maximum (audio and video internal units or ringtunes).

### EXAMPLE - TWO AUDIO INTERNAL UNITS IN ADDITION TO THE BASIC AUDIO INTERNAL UNIT

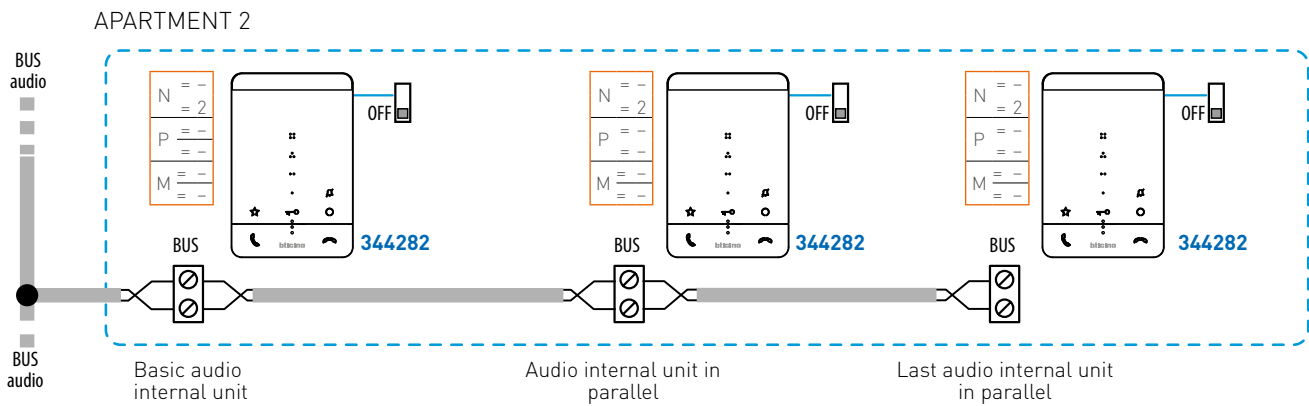

### EXAMPLE - ONE AUDIO INTERNAL UNIT AND ONE RINGTONE, IN ADDITION TO THE BASIC VIDEO INTERNAL UNIT

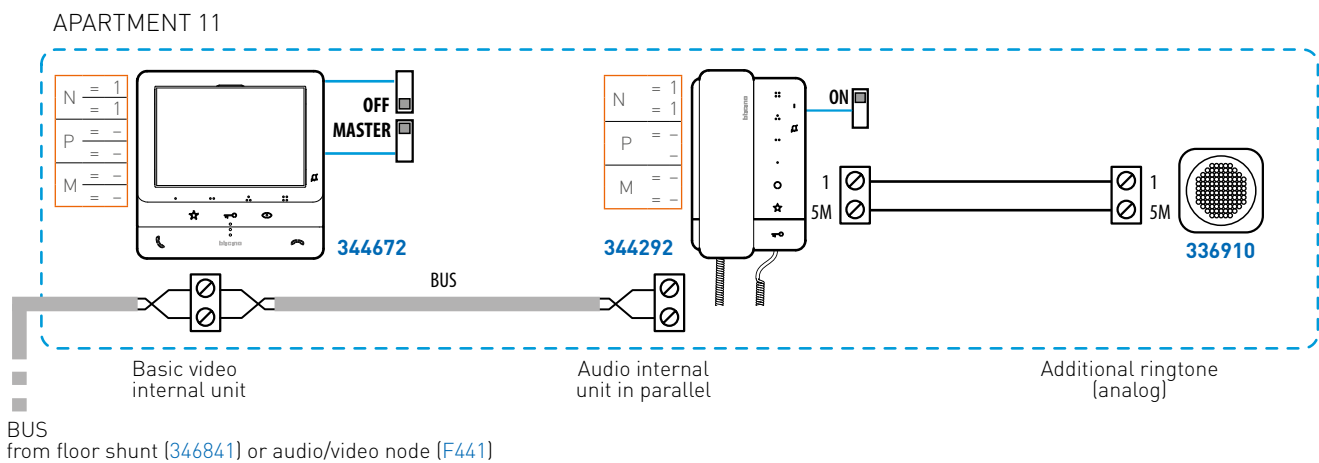

### EXAMPLE - TWO AUDIO INTERNAL UNITS IN ADDITION TO THE BASIC VIDEO INTERNAL UNIT

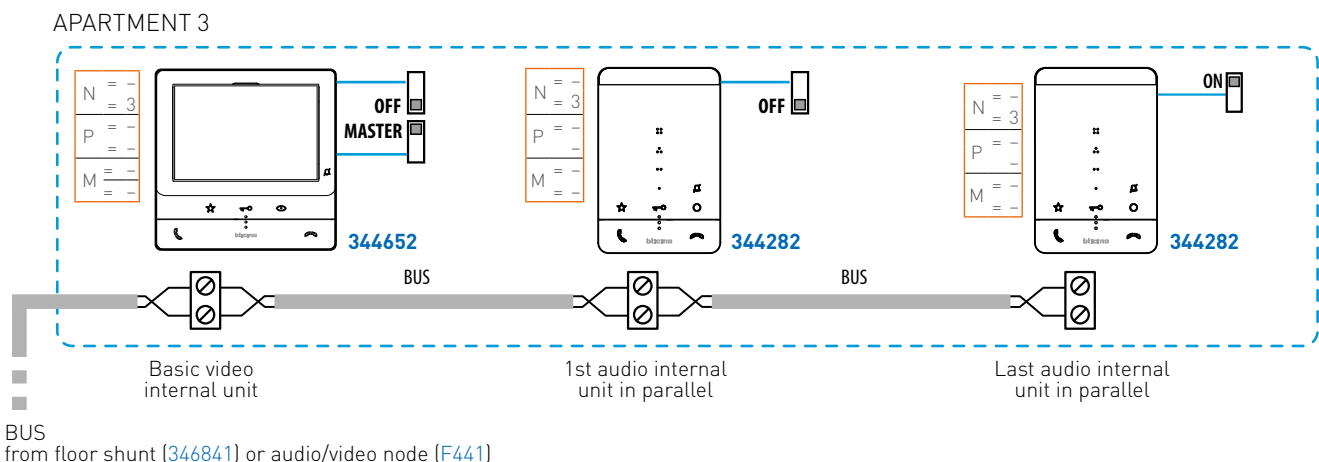

# Internal Unit Variants - Multifamily systems without apartment interface 346850

## EXAMPLE - TWO VIDEO INTERNAL UNITS IN ADDITION TO THE BASIC VIDEO INTERNAL UNIT

The variant is **NOT** possible with IU without MASTER/SLAVE function

- This variant DOES NOT allow the simultaneous switching on of the video internal units
- The variant is NOT possible with C300EOS and Hometouch internal units.

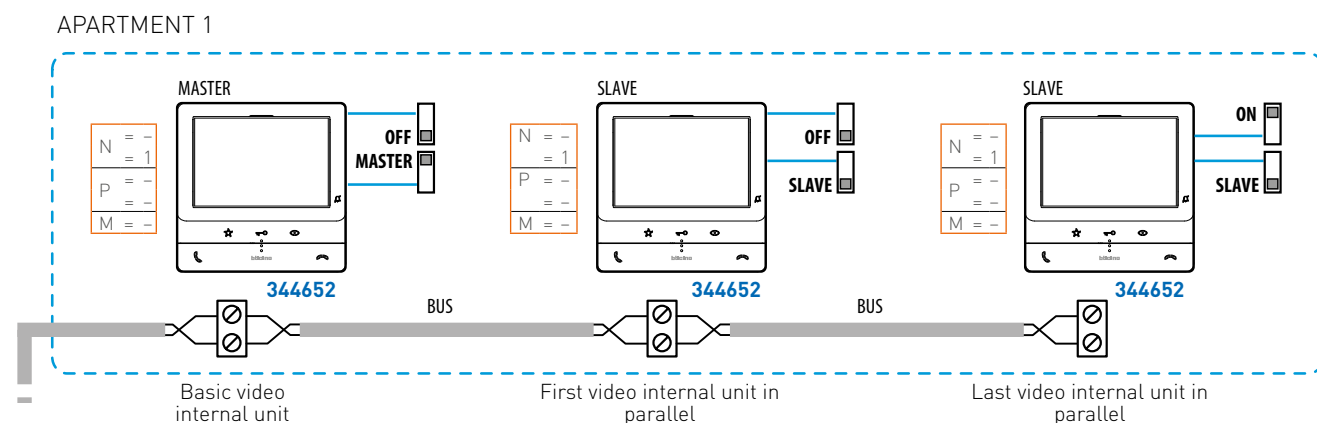

IU BUS  
from floor shunt (346841) or audio/video node (F441)

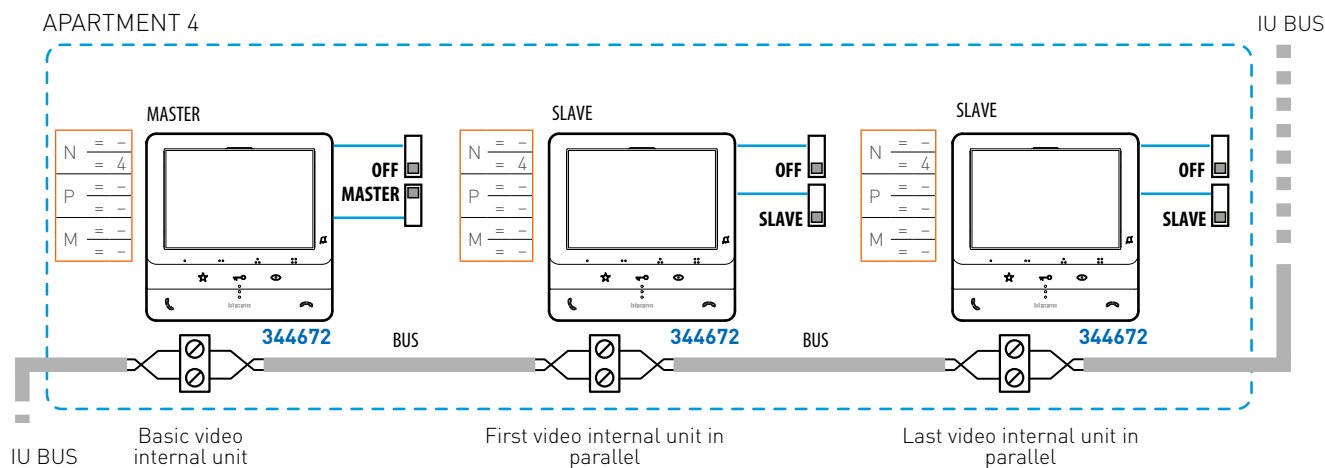

**EXAMPLE - THREE VIDEO INTERNAL UNITS IN SIMULTANEOUS SWITCHING ON**

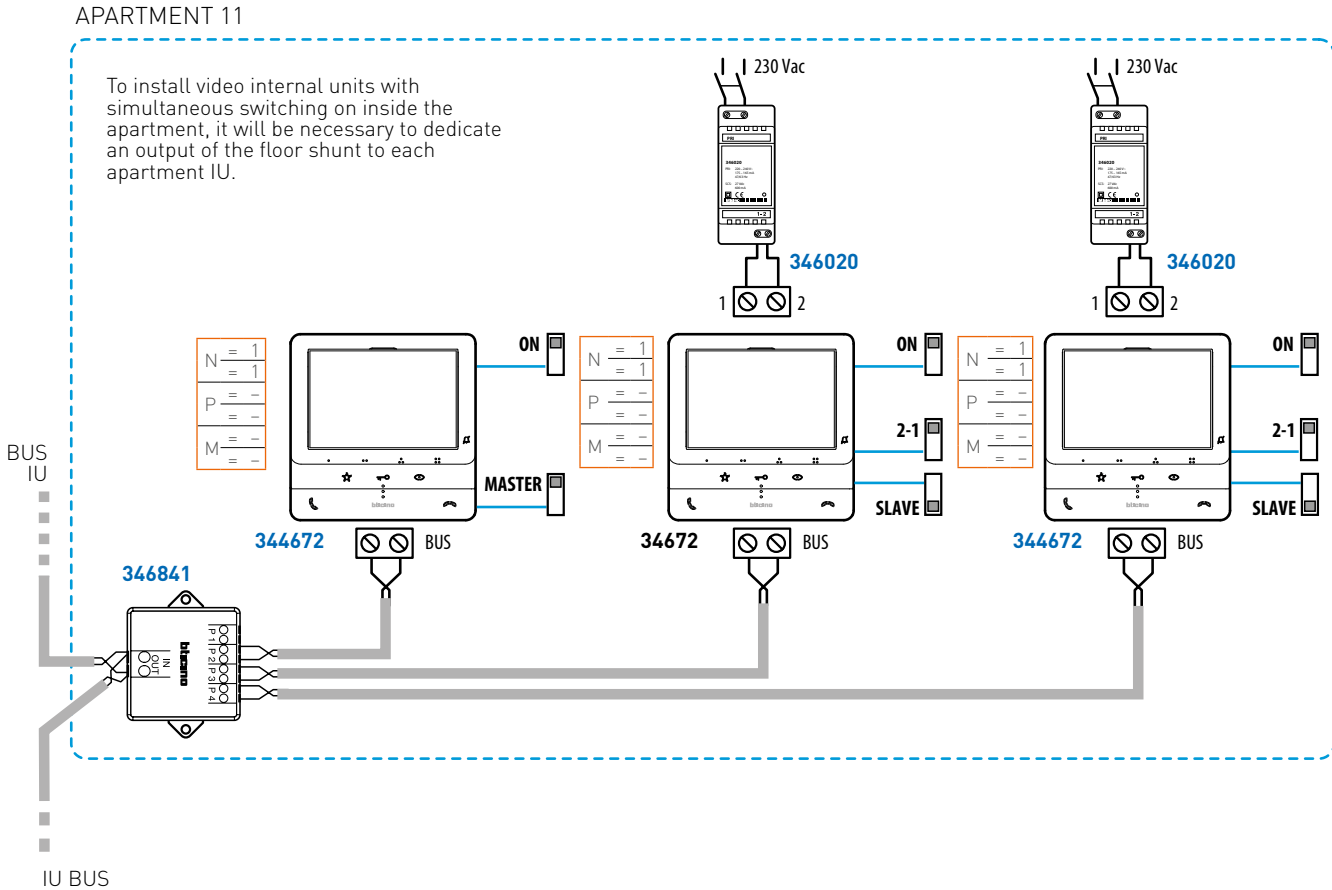

**EXAMPLE - ONE AUDIO INTERNAL UNIT AND ONE ADDITIONAL RINGTONE IN ADDITION TO THE BASIC VIDEO INTERNAL UNIT**

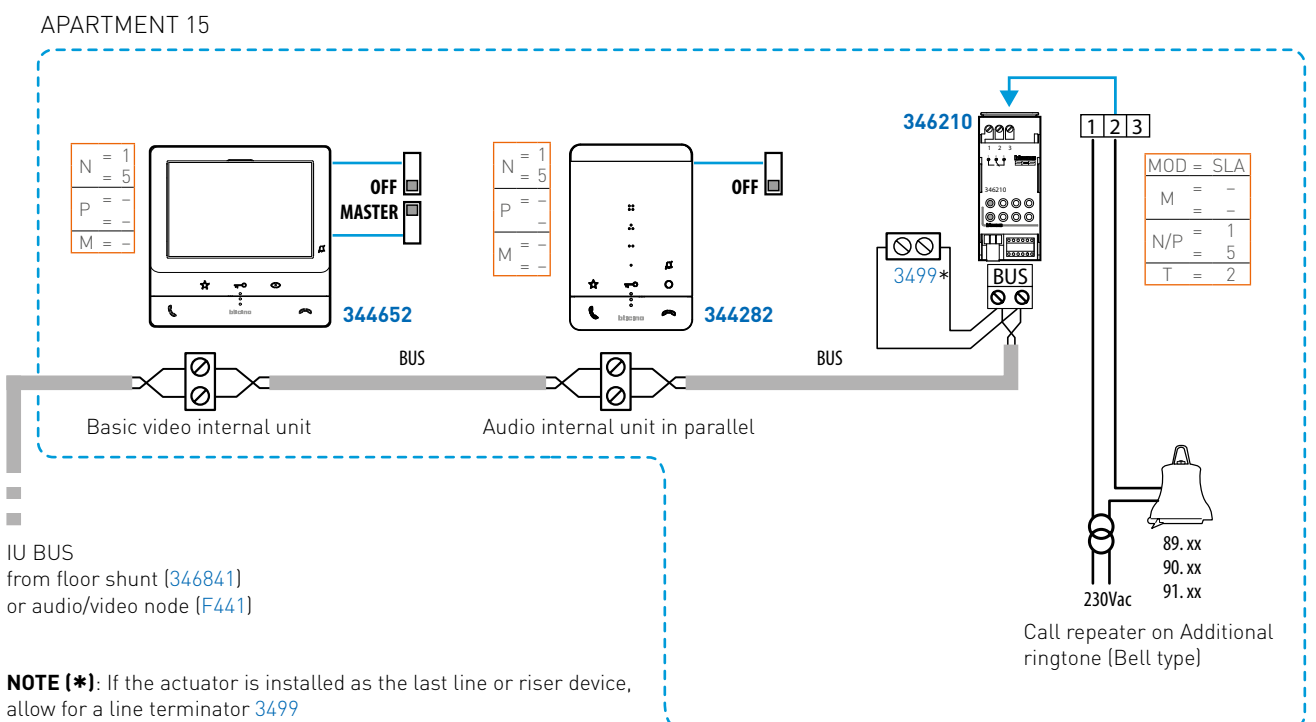

**NOTE (\*):** If the actuator is installed as the last line or riser device, allow for a line terminator **3499**

# Wiring diagrams variants for DIN rail devices

## AUDIO / VIDEO NODE F441

By using the audio/video node, it is possible to connect up to 4 video entrance panels / cameras (or 4 audio/video nodes in cascade) and up to 4 two WIRES video risers.

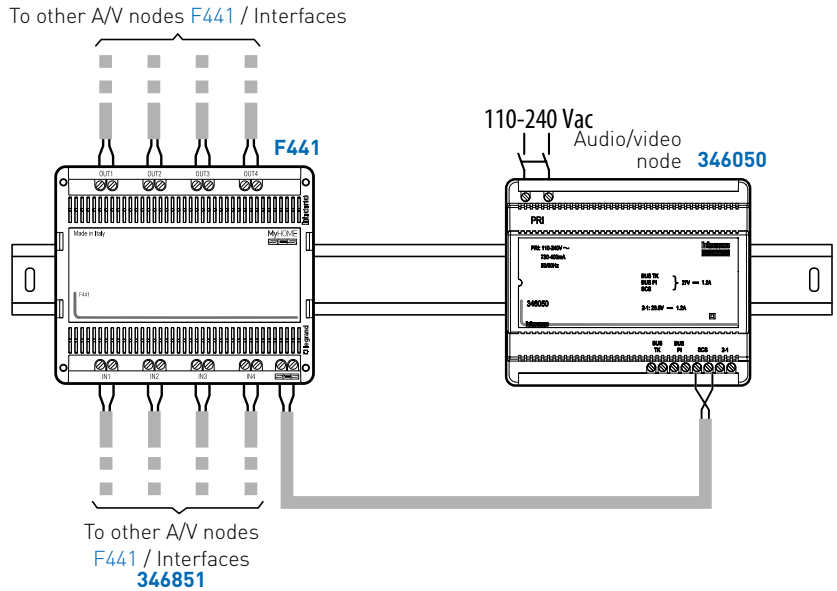

## MULTI-CHANNEL MATRIX F441M

In alternative to the audio/video node F441, it is also possible to use the multichannel matrix F441M. The matrix makes it possible to connect (on the input) up to 4 Entrance Panels. Up to 8 risers can be generated on the output.

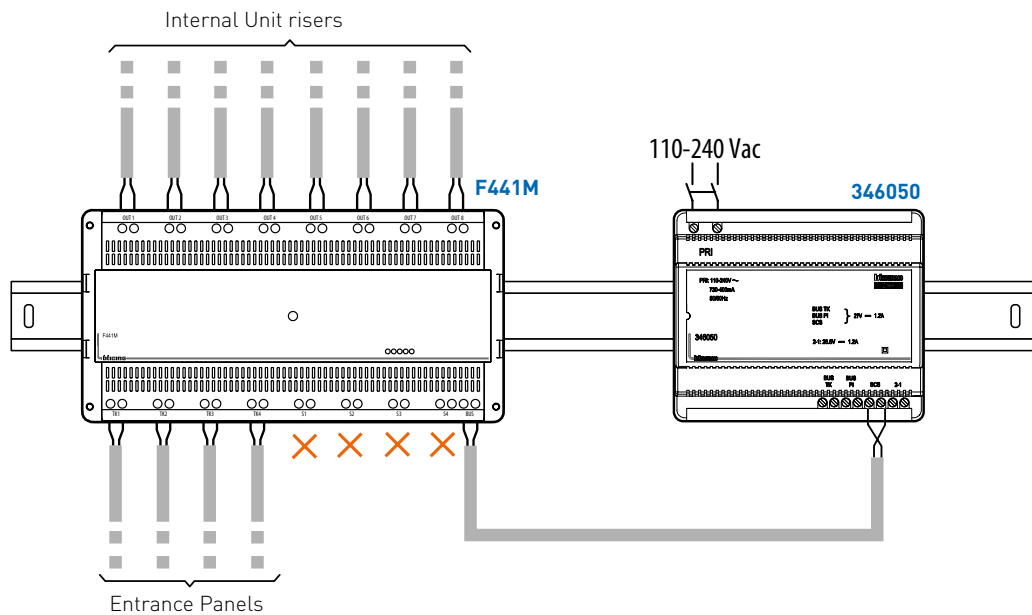

**CAUTION:** the multichannel matrix is NOT compatible with Classe 300EOS and Hometouch internal units.

## INTERCOM IN APARTMENT WITH 2 DIN COMPACT POWER SUPPLY 346030

In order to have the **apartment intercom** function whilst saving DIN modules, it is possible to use, as an alternative to the power supply 346050, compact power supply 346030 wired as follows:

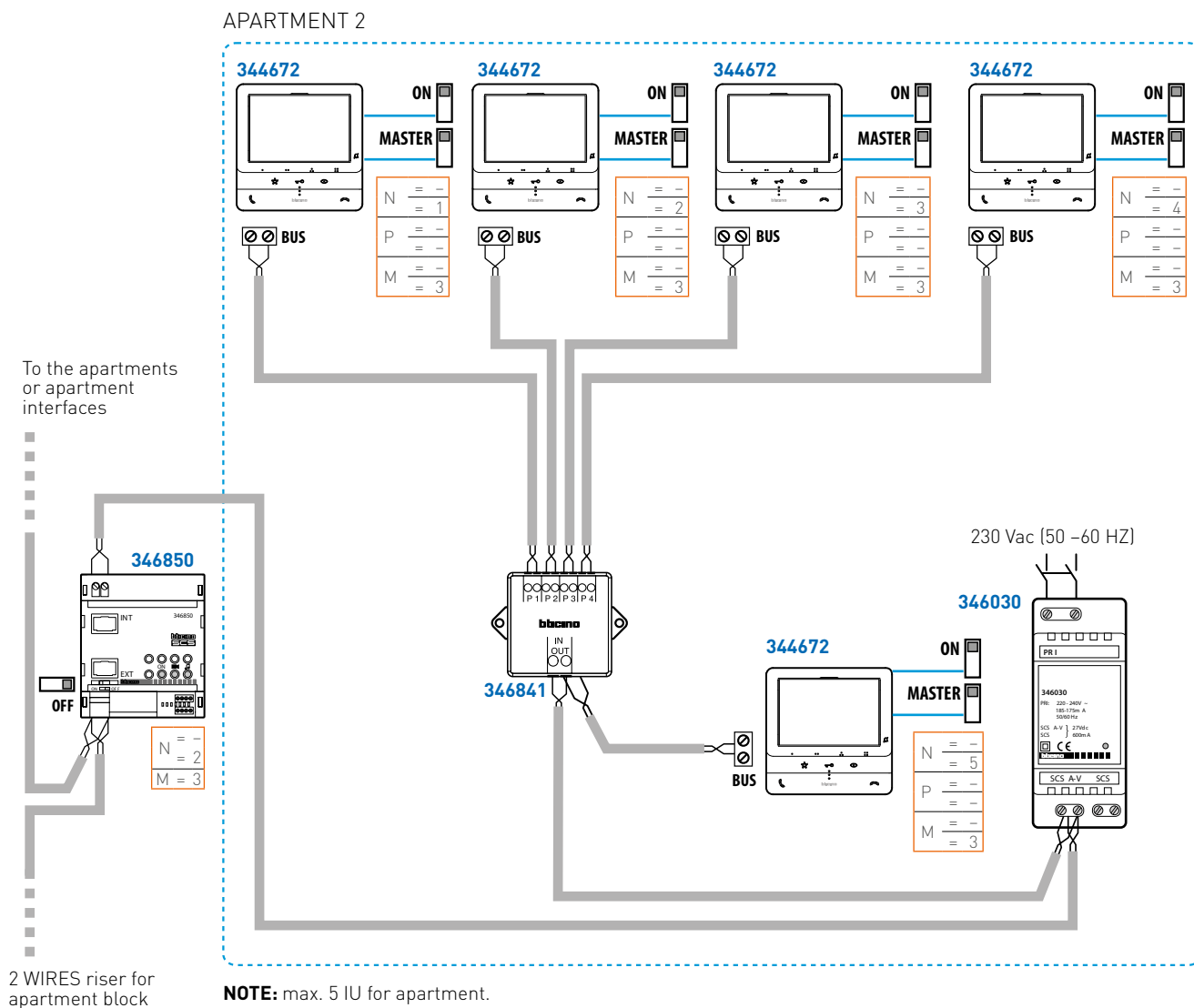

# Wiring diagrams variants for DIN rail devices

## 8/2 WIRES INTERFACE 346150

The diagrams only show one 2 WIRES riser Entrance Panel: with these variants, it is possible to install one video EP and up to 2 audio EP.

**CAUTION:** the 8/2 wires interface is NOT compatible with Classe 300EOS internal units.

**⚠ CAUTION**

\* When connecting wires 1 and 2, strictly comply with the numbering, in order to avoid possible malfunctioning.

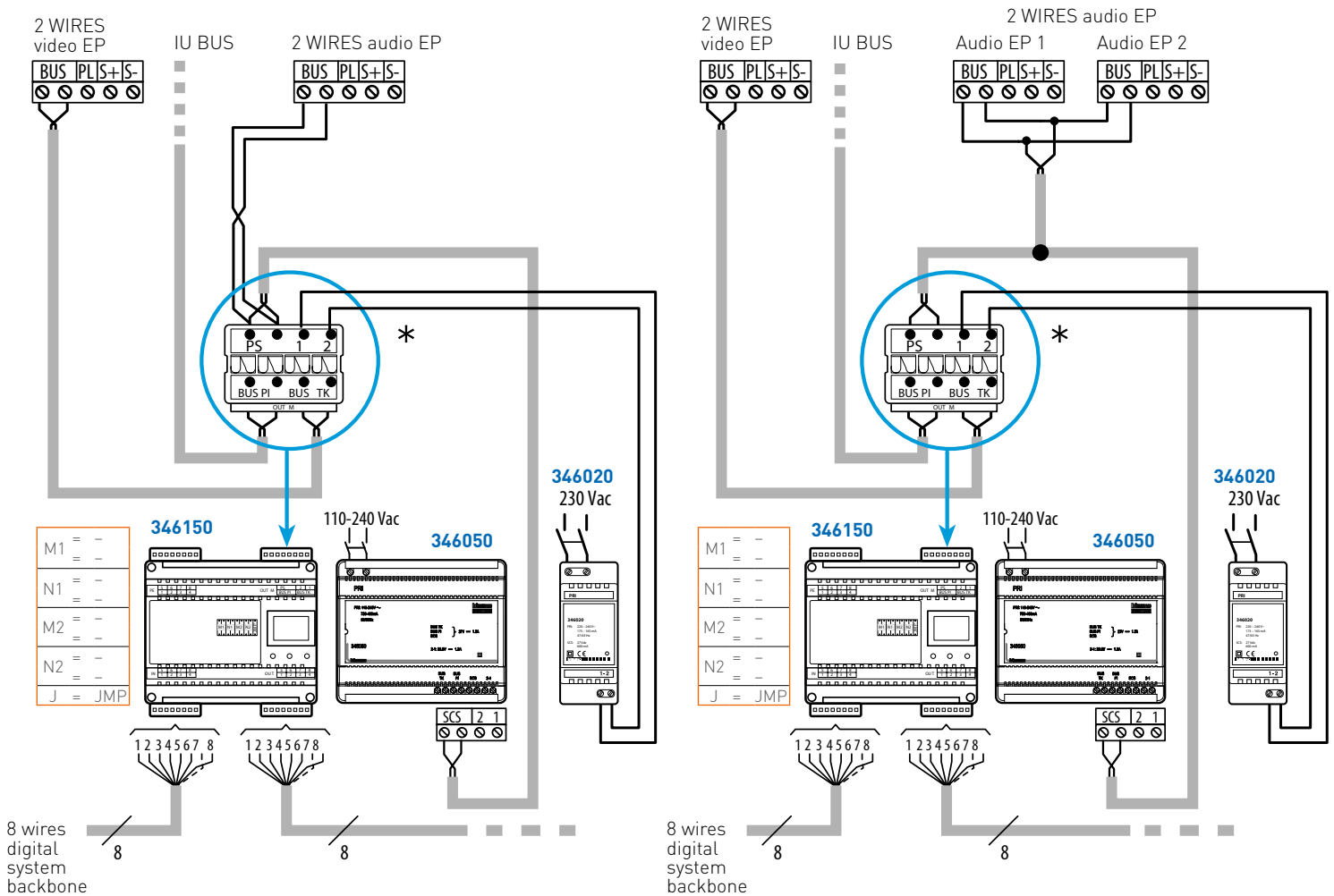

Interfaces 346150 must always be properly configured

**CONNECTION IN APARTMENT WITH 6 DIN POWER SUPPLY 346050**

In order to connect an apartment EP saving DIN modules, it is possible to use the power supply 346050 without A/V node.

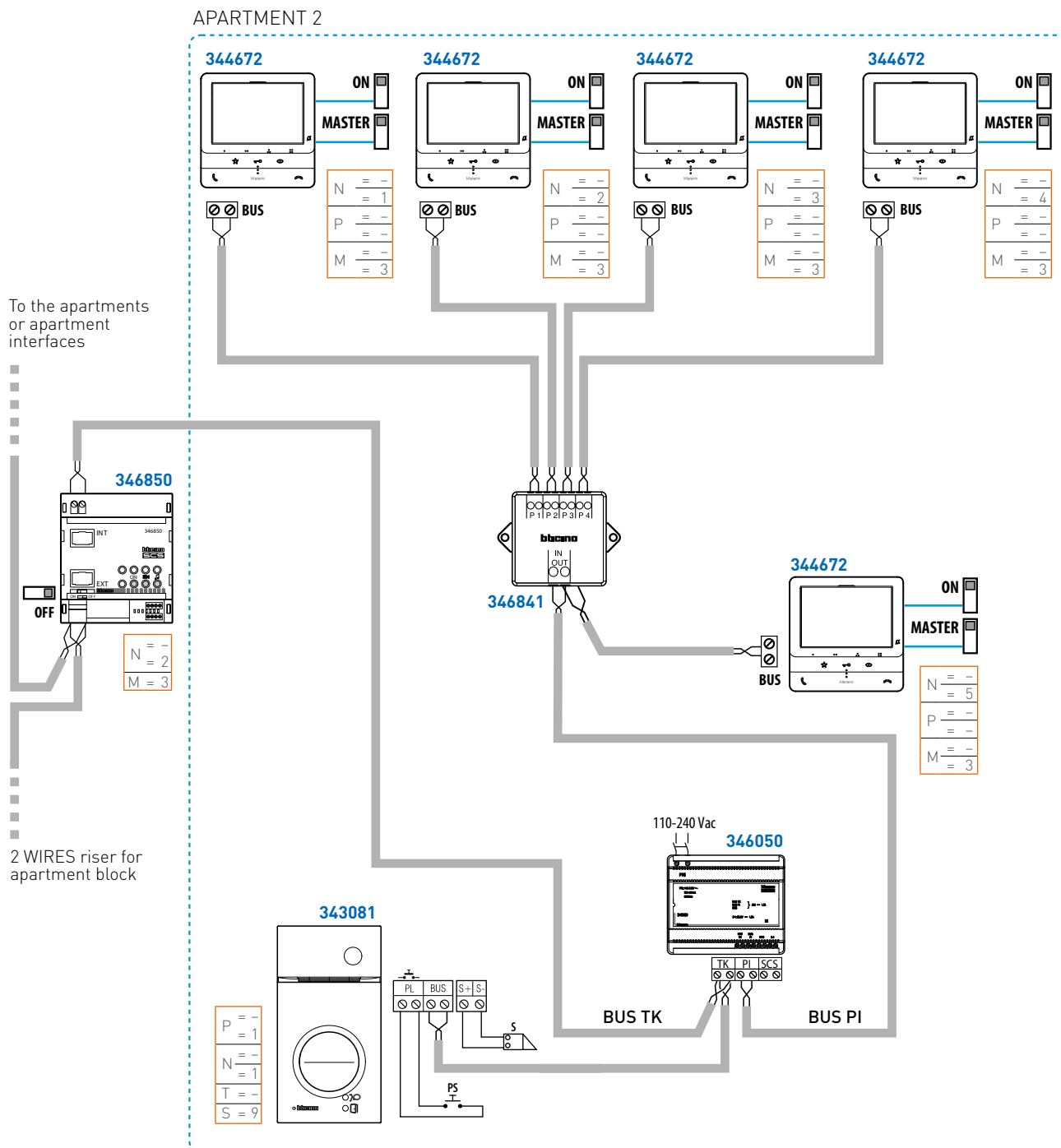

**CAUTION**

- Configure the apartment Entrance Panels from P = 1.
- Configure the apartment IU from N = 1
- As for one-family systems, all internal units must be configured as MASTER. The internal unit configured with N= 1 rings and switches on, while the others ring. If the call is answered from an internal unit with the monitor switched off, the monitor of the internal unit configured with N = 1 switches off and the monitor of the internal unit being used for answering switches on.

# Wiring diagrams variants for DIN rail devices

## RISER CONNECTION WITH 6 DIN POWER SUPPLY 346050

In order to connect an apartment EP saving DIN modules, it is possible to use the power supply 346050 without A/V node.

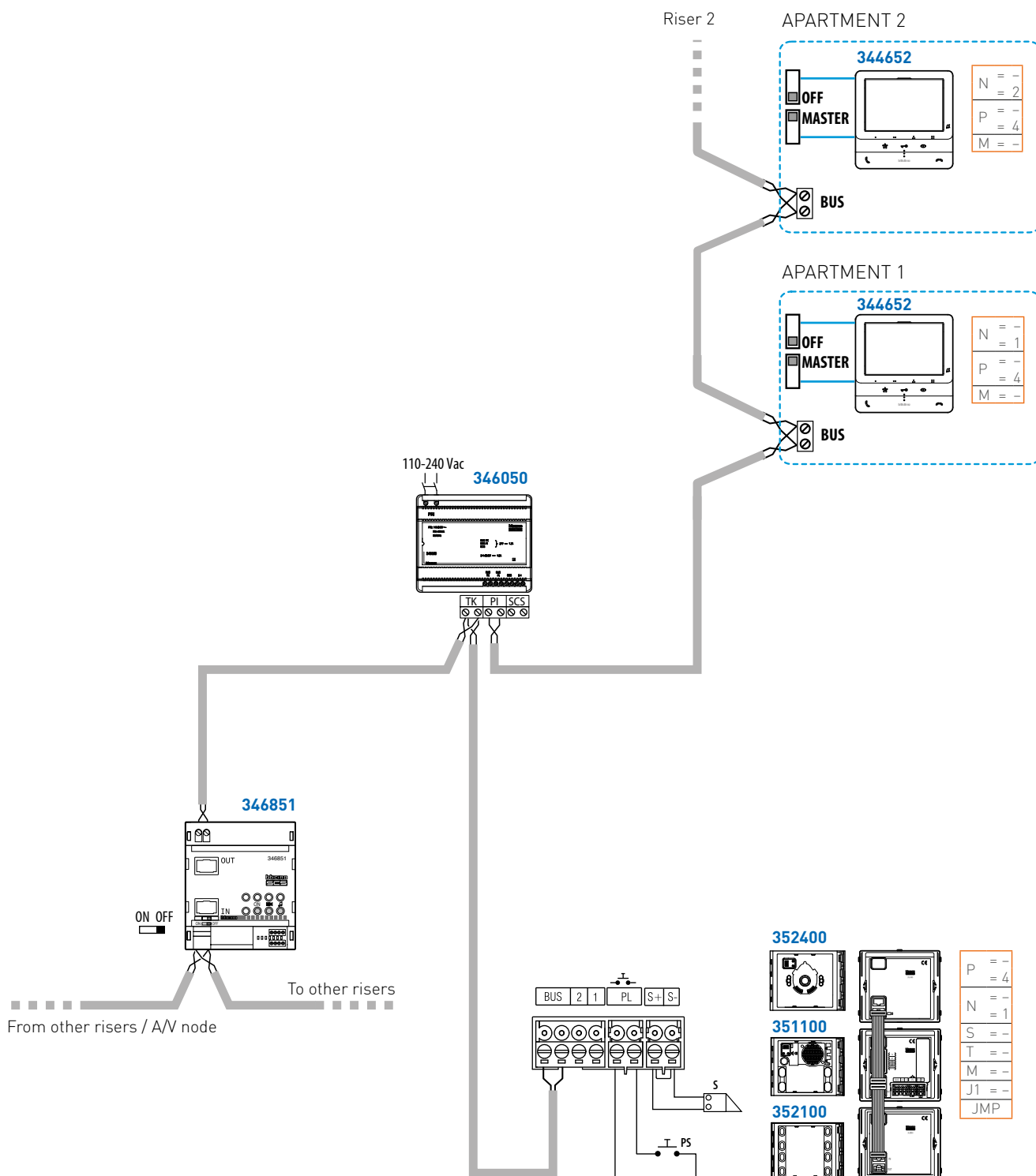

**NOTE:** It is not possible to add other riser entrance panels without using the audio/video node F441.



# Auxiliary services – Floor call

## FLOOR CALL

With CLASSE 100, CLASSE 300EOS and SPRINT L2 344232) internal units, it is possible to have the "call to the floor" function". In other words, by connecting a pushbutton between the clamps (  $\frac{T}{\sigma}$  ) it is possible to use the internal ringtone of the devices to make the call from the apartment entrance door. In installations with IU in parallel, only the Internal Unit to which the call pushbutton is connected will ring.

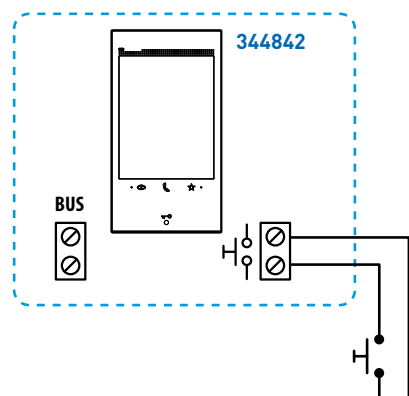

**EXAMPLE** - Connection of a CLASSE 300EOS video internal unit

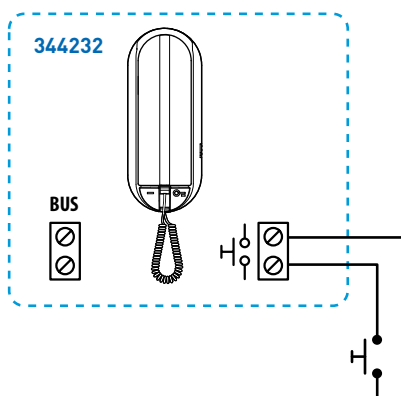

**EXAMPLE** - Connection of a SPRINT L2 audio internal unit

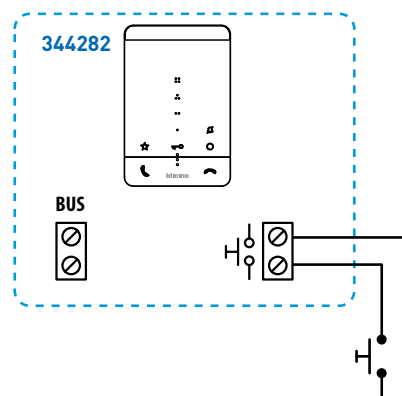

**EXAMPLE** - Connection of a CLASSE 100A16E handsfree audio internal unit

- The maximum distance between the call to the floor pushbutton and the internal unit is 15 metres.

## BUS FLOOR CALL WITH INTERFACE 346833

To be used for the call to the floor, so that several internal units connected to the BUS will ring with one single button. By using the call to the floor interface, the following is possible by pressing one pushbutton:

- the addressed floor call MOD = 0
- the general floor call MOD = 1

### ADDRESSED FLOOR CALL WITH 346833 CONFIGURED WITH MOD = 0

APARTMENT 12

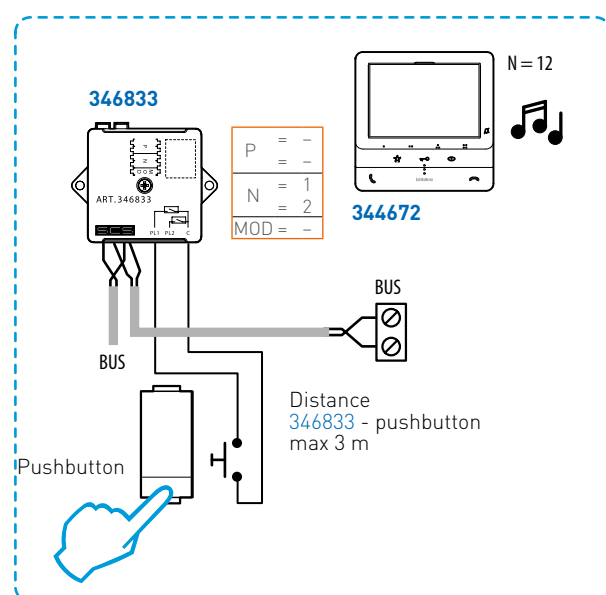

APARTMENT 3

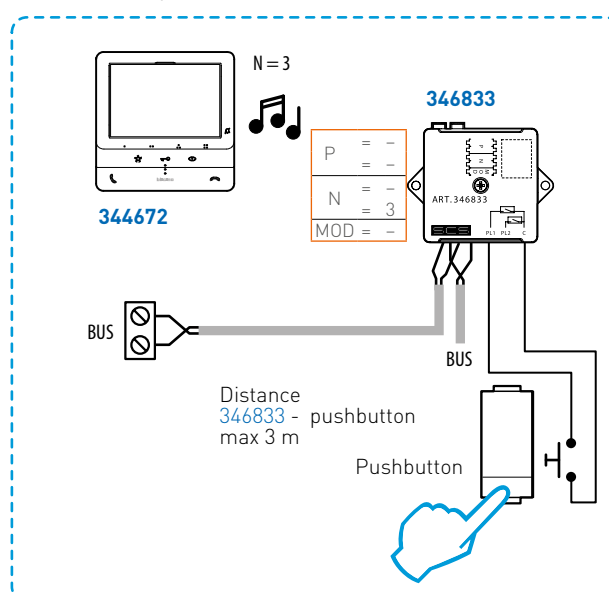

# Auxiliary services – Floor call

## GENERAL FLOOR CALL WITH 346833 CONFIGURED WITH MOD = 1

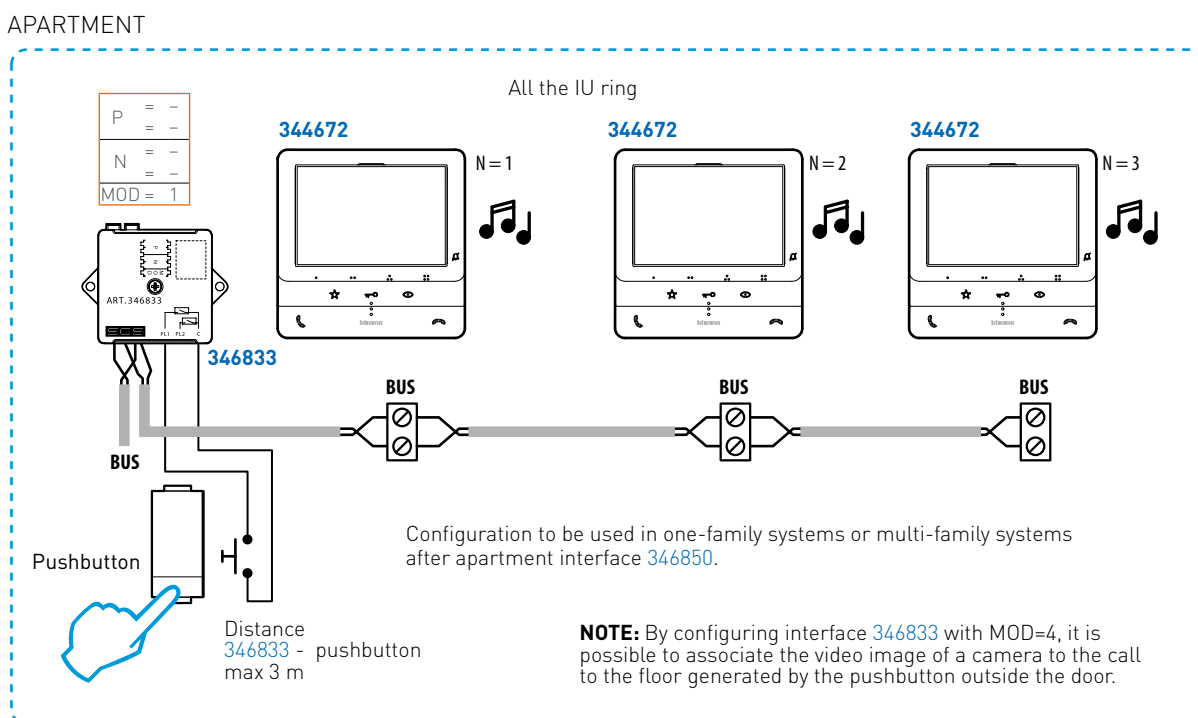

## BUS FLOOR CALL WITH SPECIAL CONTROL L4651M2/H4651M2

By using special control L4651M2/H4651M2, it is possible to make the call to the floor through the BUS. By inserting the special control on the IU BUS (in video systems, the special control must be in-out connected on the IU BUS) and configuring it for the call to the floor, it is possible to have the function without further wiring between entrance and Internal Unit. In installations with IU in parallel, upon arrival of the call to the floor all the Internal Units of the apartment ring.

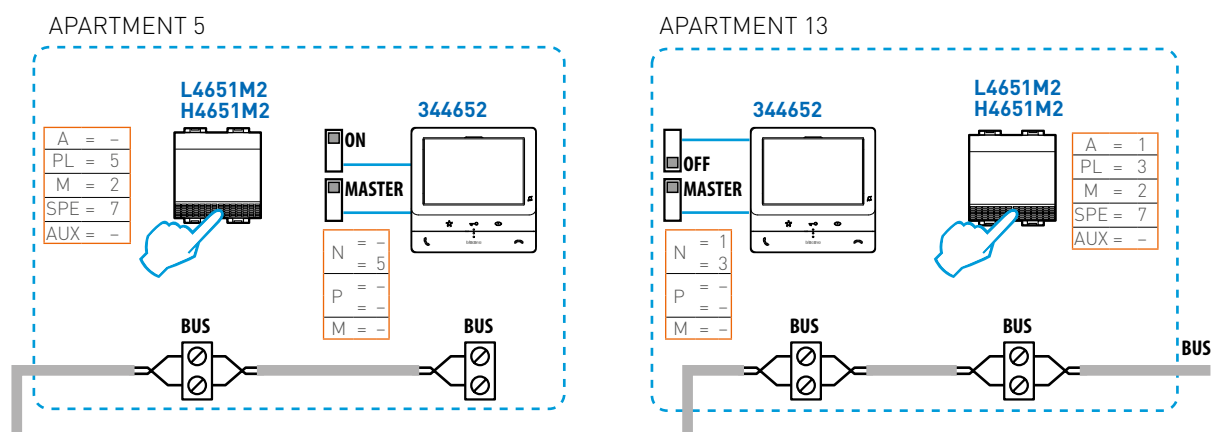

**EXAMPLE** - BUS floor call - connection before the Internal Unit

**EXAMPLE** - BUS floor call - connection after the Internal Unit. If the special control is connected as the last apartment or riser line device, it is necessary to connect a 3499 terminator in an IN-OUT mode on the control itself.

# Auxiliary services – Door lock control

## DOOR LOCK CONTROL CONNECTION

### SFERA ENTRANCE PANELS

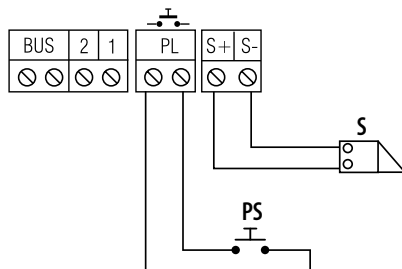

Wiring for door lock release control from the appropriate IU key and the PS key. Between S+ and S- are available 18 V -4 A impulsive (250 mA holding current) 30 Ohm max. Timing from key (PS) as per the configurator in (T) of the speaker module.

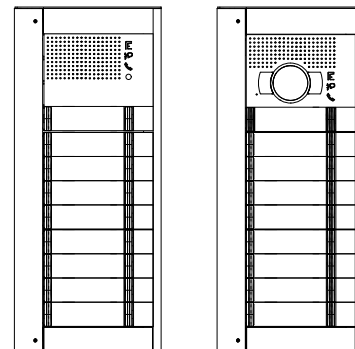

### LINEA 300 ENTRANCE PANELS

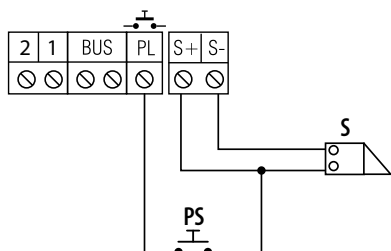

Wiring for door lock release control from the appropriate IU key and the PS key. Between S+ and S- are available 18 V -4 A impulsive (250 mA holding current) 30 Ohm max

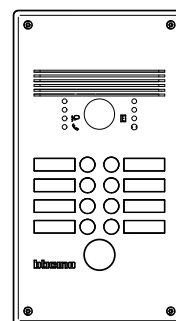

### LINEA 2000 ENTRANCE PANELS

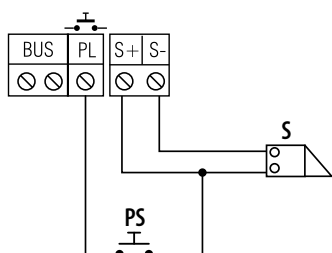

Wiring for door lock release control from the appropriate IU key and the PS key. Between S+ and S- are available 18 V -4 A impulsive (250 mA holding current) 30 Ohm max.

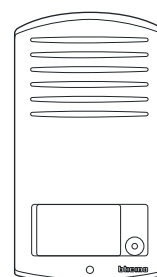

342911

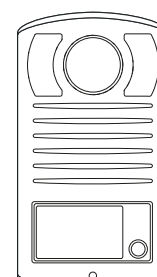

343031

### LINEA 3000 ENTRANCE PANELS

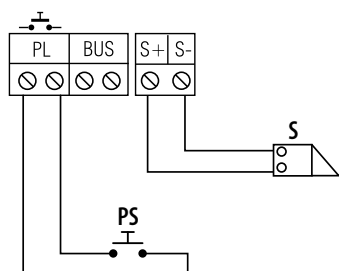

Wiring for door lock release control from the appropriate IU key and the PS key. Between S+ and S- are available 18 V -4 A impulsive (250 mA holding current) 30 Ohm max. Timing from key (PS) as per the configurator in (T) of the speaker module.

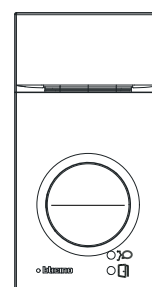

343071

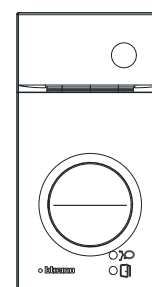

343081  
343091  
343093

# Auxiliary services - Door lock control

## DOOR LOCK CONTROL FROM BUS

(Installation in video systems)

By using special control L4651M2/H4651M2, the door lock release control is timed

The pushbutton marked with X opens the door lock of the Entrance Panel configured with P = 0 (the special control configured with A=0 and PL=0 acts on the EP configured with P=0).

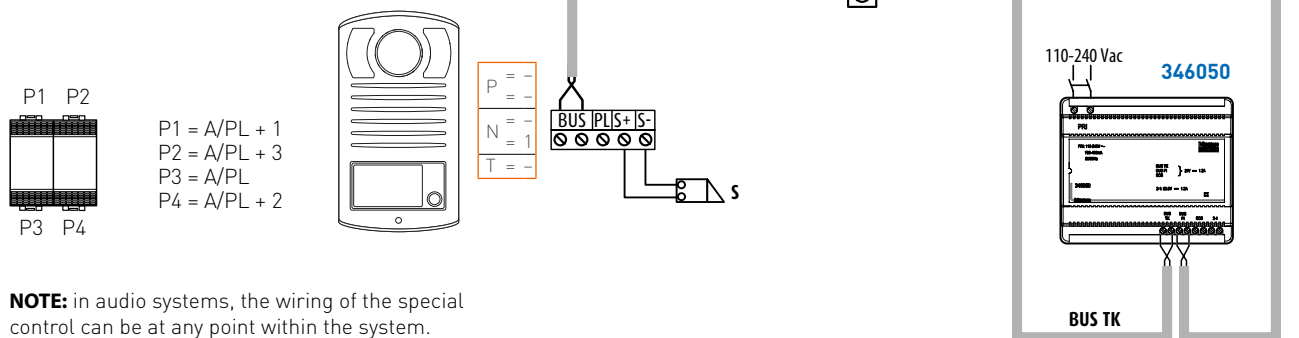

**NOTE:** in audio systems, the wiring of the special control can be at any point within the system.

## CONTROL OF 2 DOOR LOCKS WITH SFERA KEYPAD MODULE 353000

(installation in audio/audio-video systems)

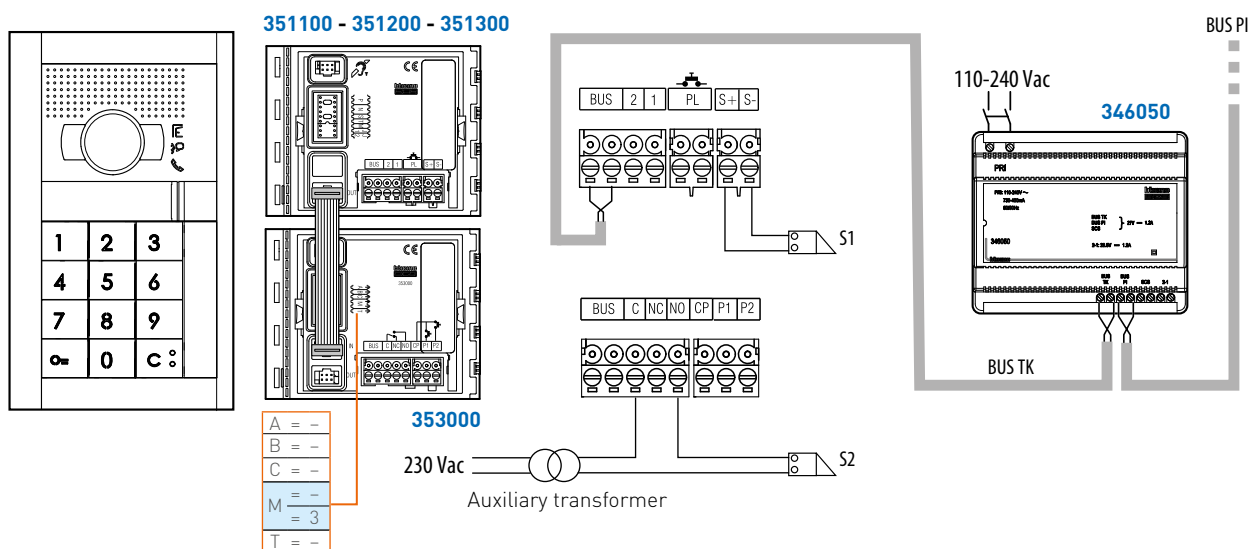

**S1** Electrical door lock 18 V  
4 A impulsive 250 mA holding  
current 30 Ohm max.

**S2** Contact output (C-NO):  
8 A 30 Vdc  
8 A 30 Vac cosφ 1  
3.5 A 30 Vac cosφ 0.4

**NOTE:** in order to control the door lock directly connected to the speaker module or audio/video module, type on the keypad **0** + door lock opening code + confirmation;  
in order to control the second door lock connected to the local relay contact, type on the keypad **0** + **0** + door lock opening code + confirmation.

## SAFETY DOOR LOCK CONTROL (VENTOUSE TYPE)

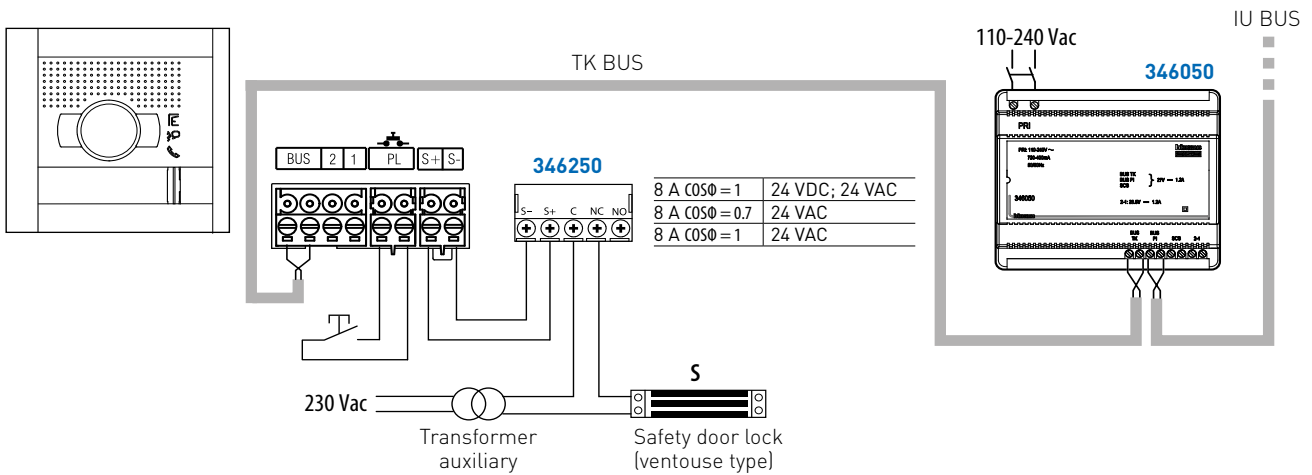

**NOTE:** The safety door lock remains closed in case of permanent voltage. It opens when the power supply is interrupted. Interruption time as per the configurator in (T) of the speaker module.

## DOOR LOCK CONTROL NOT MANAGED FROM BUS

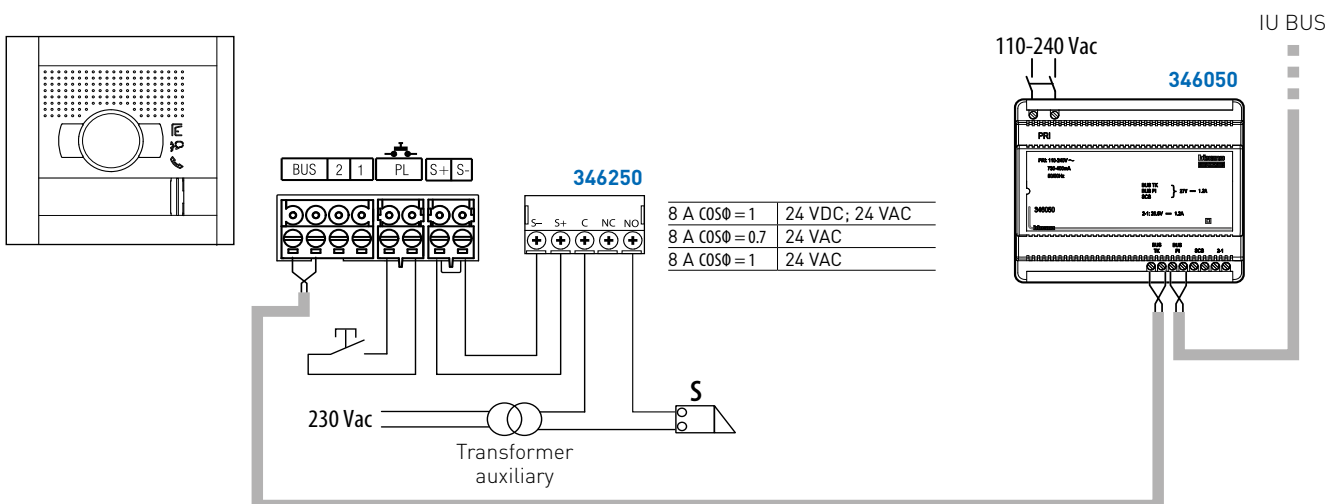

# Auxiliary services - Door lock control

## DOOR LOCK CONTROL WITH GENERIC ACTUATOR 346210

Should it be necessary to open a door lock at the same time as the one connected to the EP speaker module, or to remotely control the same, actuator 346210 can be used.

The actuator must be configured with MOD =5 and is controlled by the appropriate pushbutton of the IU and the PS key. The contacts may be crossed by a maximum current of 6 A (resistive) – 2 A (inductive) –  $\cos \varphi=0.5$ .

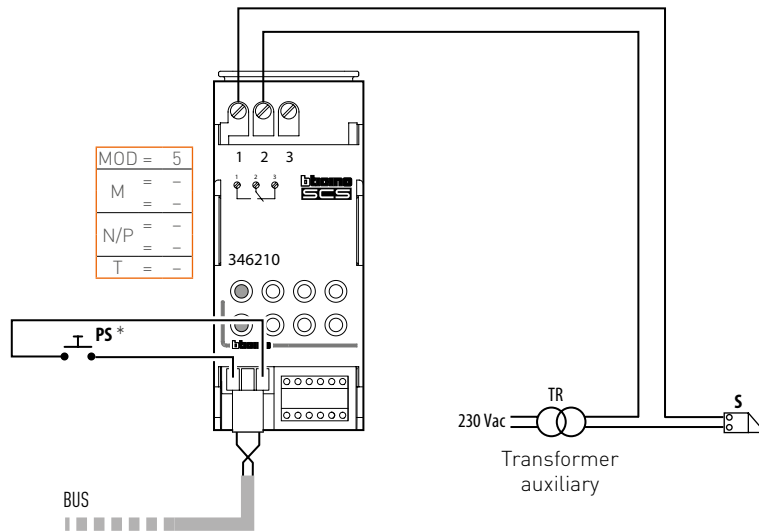

\* Contact timing activation as per configurator in T  
 - The maximum distance between the call to the floor pushbutton and the actuator is 15 metres.

## DOOR LOCK CONTROL WITH INTERFACE 346833

Call to the floor interface 346833 also gives the possibility of opening door locks using appropriately connected pushbuttons.

MOD = 2	Door lock associated in P	PL1-C
MOD = 3	Door lock associated in P	PL1-C
	Door lock associated in P+1	PL2-C

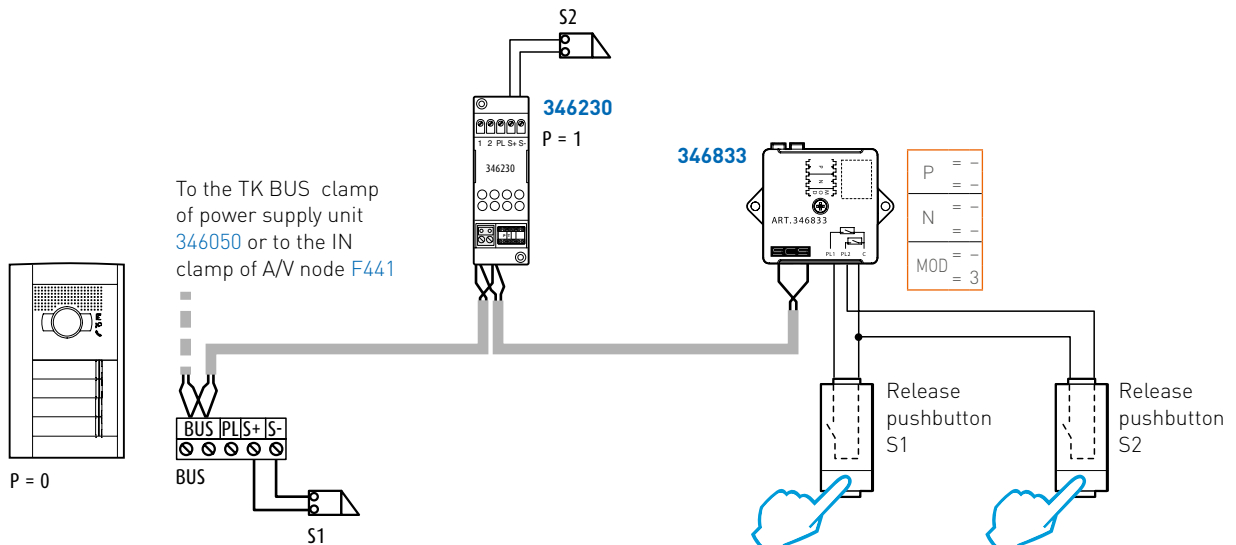

Distance 346833 – pushbutton = max 3 m

**DOOR LOCK CONTROL WITH ACTUATORS 346230 OR 346260**

The use of the actuators is indicated in installations where the direct connection of the electric door lock release is not wanted, but it is necessary to have, always with 2 wires, wiring that cannot be accessed from the Entrance Panel, positioning the actuator that controls the door lock in a remote area.

It can also be used for the implementation of the "door lock status control" function (actuator 346260 only).

The wiring is completely of the 2 WIRES type, including the power supply to the electric door lock.

The actuator is controlled by the door lock pushbutton of the IU.

The device must be properly configured.

**NOTE:** in video systems, the wiring must be completed in IN-OUT mode on the TK BUS clamp of power supply unit 346050 or the IN clamp of the audio/video node.

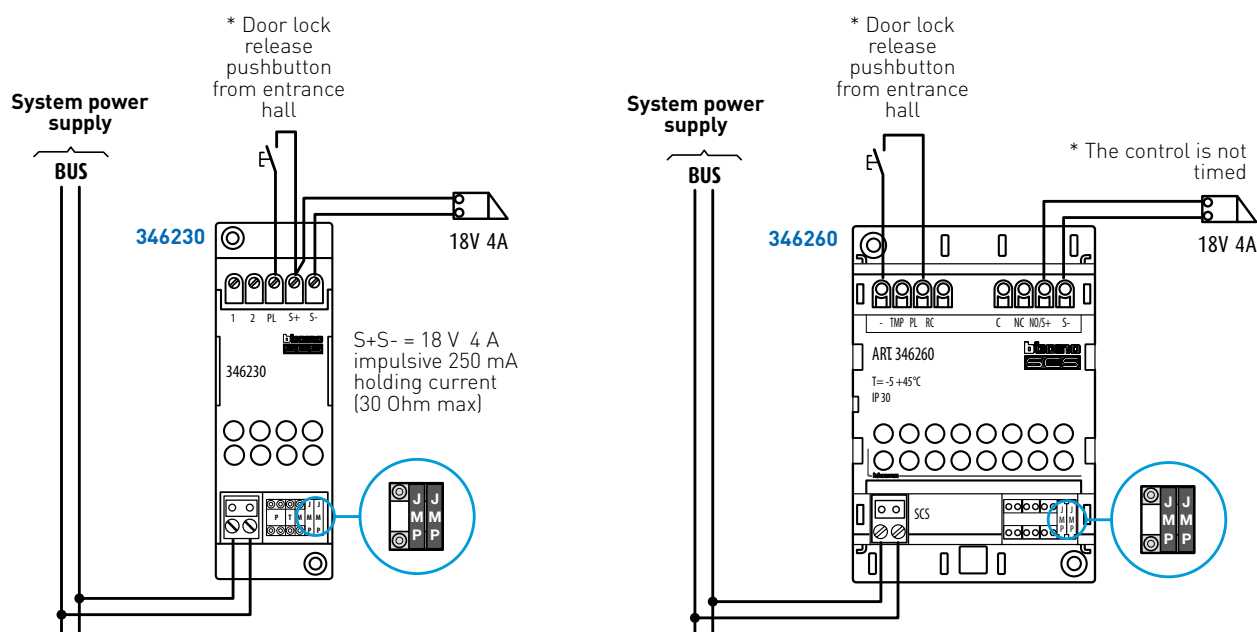

# Auxiliary services – Staircase light control

## BUS STAIRCASE LIGHT CONTROL WITH ACTUATOR 346210

(Installation in video systems)

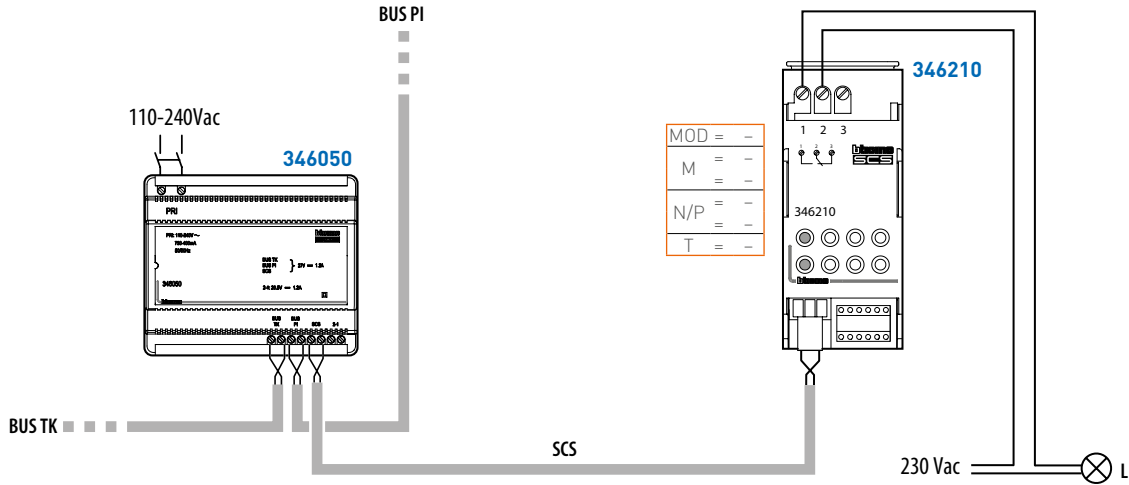

Wiring for staircase light control from the appropriate IU key, and the staircase light key of preset Entrance Panels.

**CAUTION:** the (BUS PI), (BUS TK) and (SCS) outputs can be used at the same time respecting the total maximum absorption of 1.2 A.

## BUS STAIRCASE LIGHT CONTROL WITH SPECIAL CONTROL L4651M2/H4651M2

(Installation in video systems)

By using the special control, the switching on of the light is timed.

Example associated to the IU (N=2)

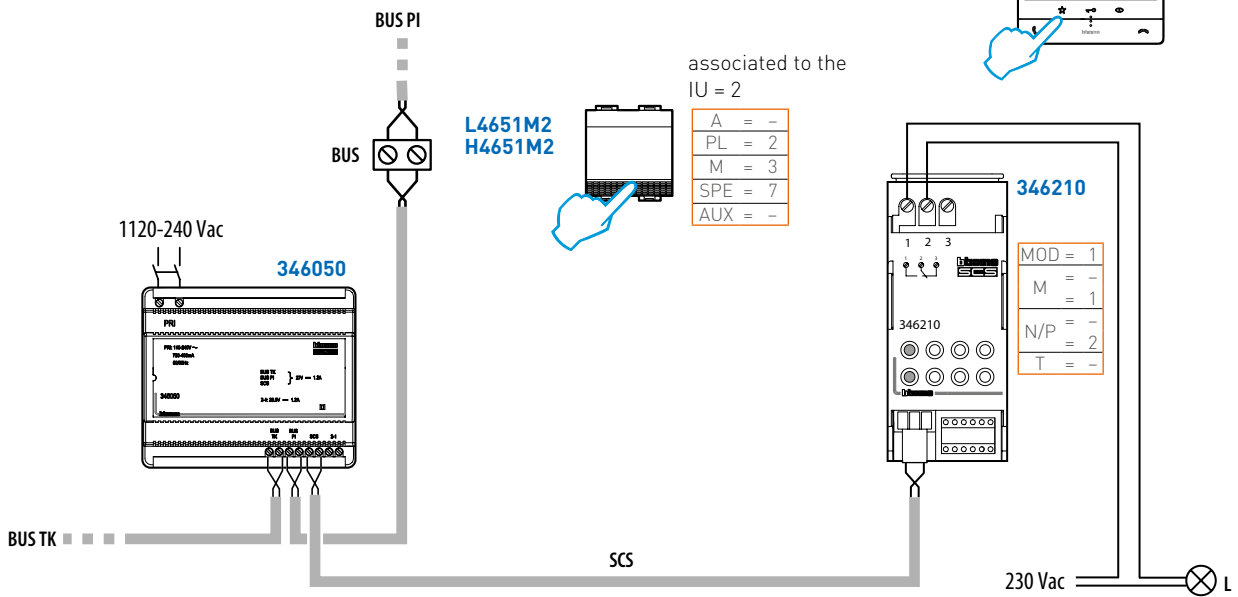
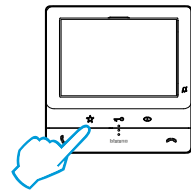

The special control acts on actuator 346210 configured to switch the lights on. For further details, see the technical sheets of the special control and of actuator 346210.

**NOTE:** in audio systems, the wiring of the special control can be at any point within the system



**STAIRCASE LIGHT CONTROL WITH INTERFACE 346833**

Call to the floor interface 346833 gives the possibility of switching the staircase lights on using an appropriately connected pushbutton.

MOD = 0	Staircase Lights	} PL2-C
MOD = 1		
MOD = 2		

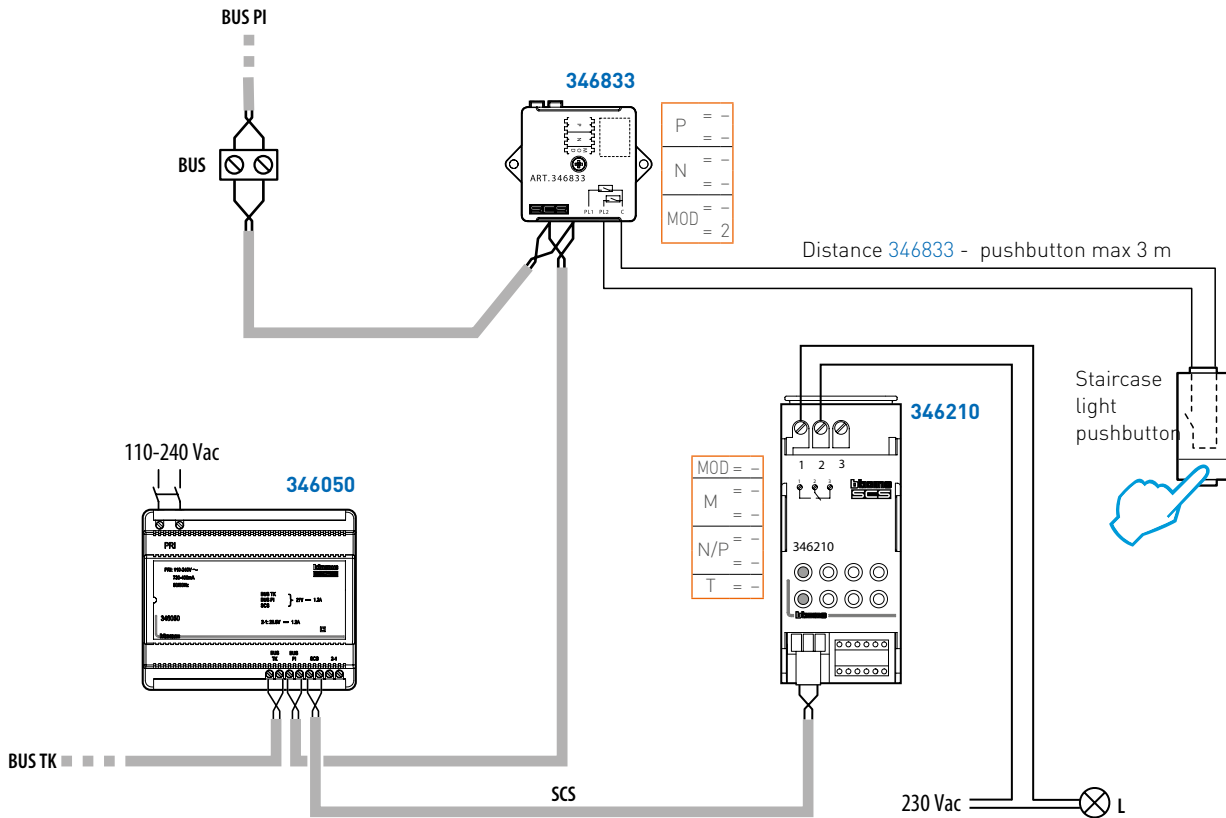

**LIGHT CONTROL FOR THE ILLUMINATION OF THE CAMERA FIELD OF VIEW**

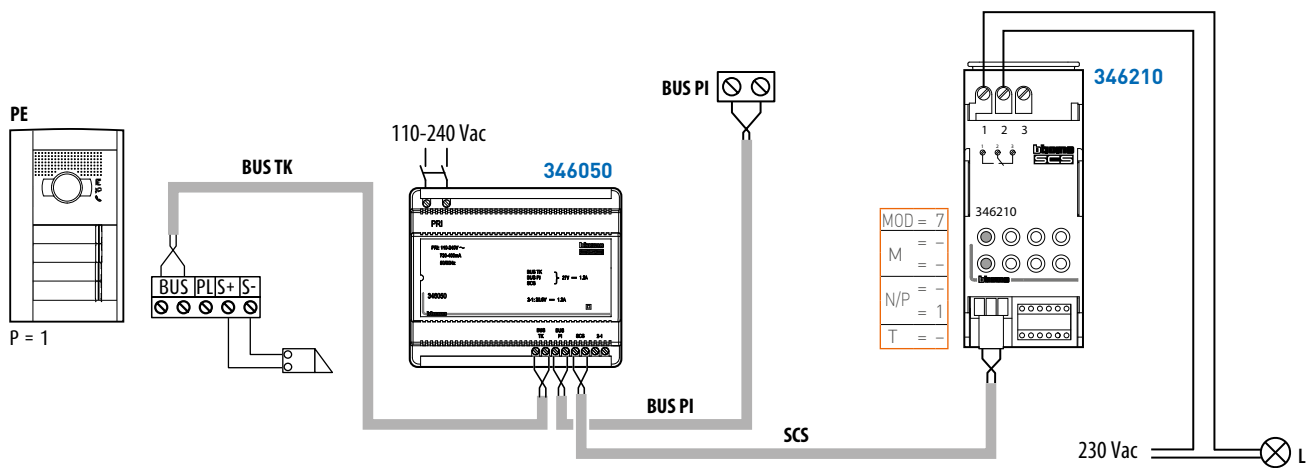

Closure of the contact upon call from the EP configured with P=1. The contact opens after the call is ended and the handset is put down, or after 30 s (without answer).



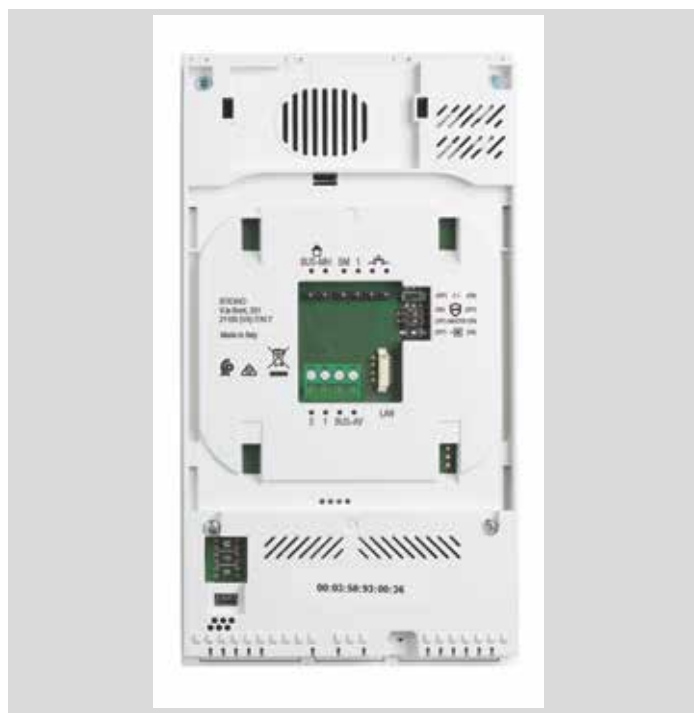
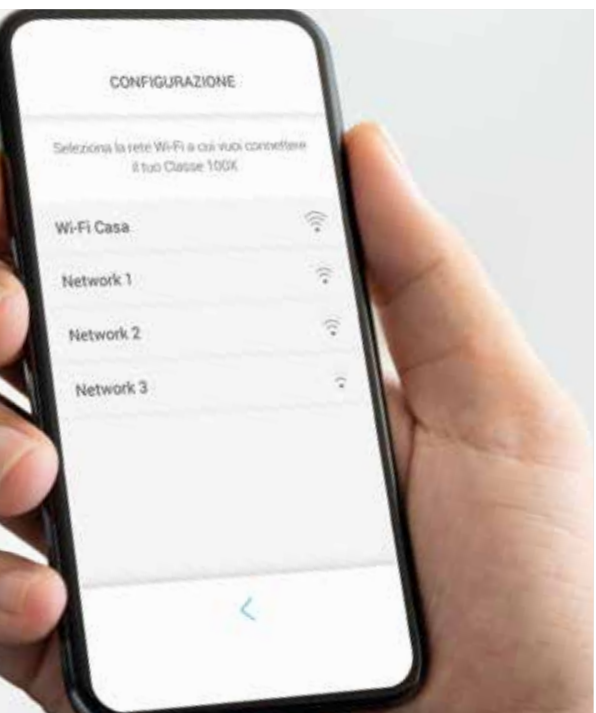

## 4 INSPECTION AND PUTTING INTO OPERATION

# Inspection and putting into operation of a 2 WIRES system

## INSPECTION

After completing the installation of the 2 WIRES audio or video door entry system, before powering the circuit it will be necessary to control that all wiring is correct and that internal units, entrance panels, actuators and all other system accessories have been configured as required.

If all the checks give positive results, carry out the following system operation tests:

- 1) Power the system and wait 1 minute for all the devices to switch on. Make a call from the entrance panel to the first internal unit: this will send an electronic signal to the speaker of the internal unit and a call confirmation sound to the entrance panel speaker module that has made the call.

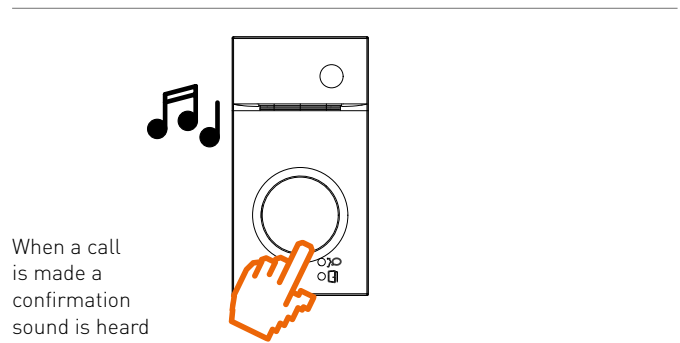

- 2) By plugging the appropriate configurator to the **M** housing, it is possible to disable the door lock sound or all the sounds at the entrance panel.

Example for SFERA entrance panels  
(for other entrance panels the configurators are different)

Configurator	M = 0	M = 1	M = 2	M = 3
Tone status	All tones enabled	Door lock tone disabled	Call tone disabled	All tones disabled

- 3) When the internal unit rings, press the connection key or lift the handset to establish communication with the entrance panel. In video systems, after the call tone the video internal unit monitor switches on; if the call is from an audio only entrance panel, the monitor stays off.

Check that sound travels in both direction (from and to the entrance panel), and that images are displayed correctly.

Make test calls from all the entrance panels to all the internal units of the system.

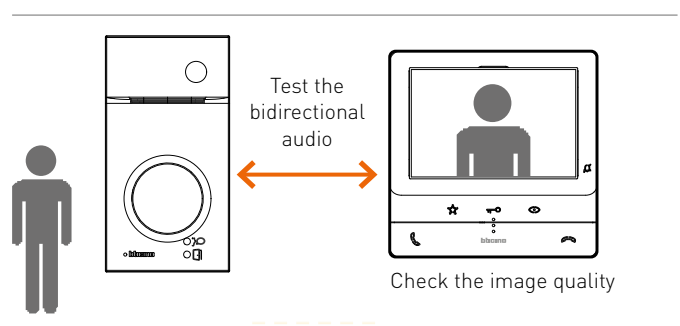

- 4) Check all the internal units to make sure that the door lock, entrance panel auto-switching on and staircase light keys (if present) are working correctly. Check that with the internal unit idle (no active call) the door lock button operates the door lock of the associated entrance panel, and that with the call active it operates the door lock of the entrance panel that has made the call.

With digital call module (display 352500 or display 352500 + keypad 353000), check that the address book contains the contacts of all residents and repeat the call test from step (1).

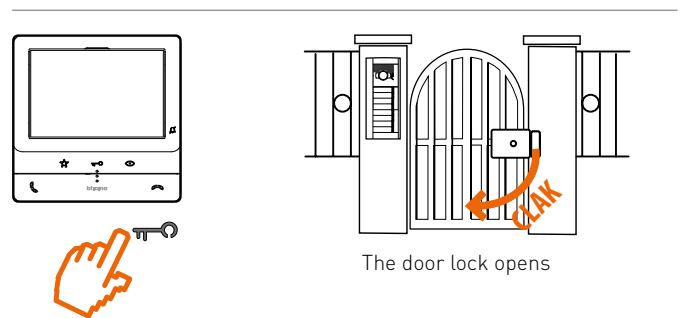

5) Check that the auto-switching on / cycling pushbutton operates the entrance panel associated to the internal unit, that cycling is performed correctly (if several entrance panels are installed), and that the door lock pushbutton operates the door lock of the entrance panel activated with the cycling procedure.

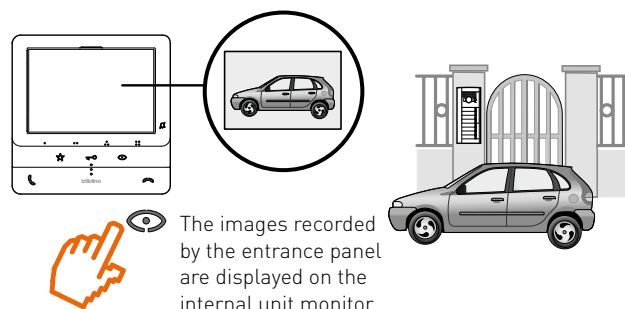

6) Check that during a conversation and for the 30 seconds after a call is sent the other internal units and entrance panels of the system (not involved in the communication) are unable to make calls. When a call is made, an engaged sound notification is heard at the entrance panel.

- Check that after 1 minute the internal unit is disconnected even if the communication has not been stopped.
- In case of isolated risers, repeat the test for each riser entrance.

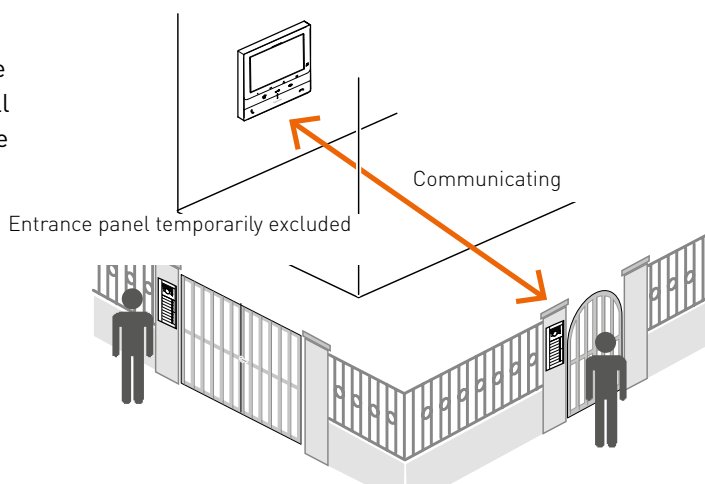

7) For systems with Intercom function, check that it is possible to call other devices, and that during the call the other internal units not involved in the communication are disabled (when a call is made an engaged sound is heard).

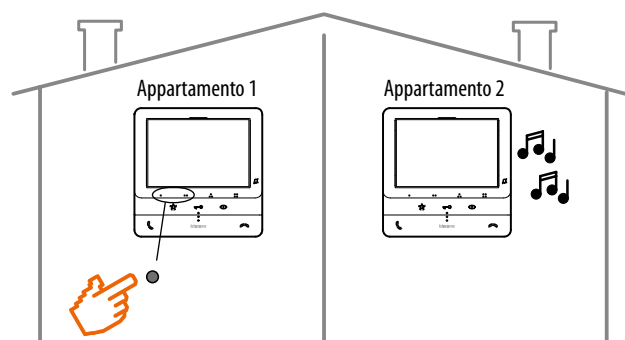

Intercom call

**Note:** The call from the entrance panel has priority on the Intercom call and will replace it.

# Inspection and putting into operation of a 2 WIRES system

If the system requires the use of one or more connected **Classe 300EOS / Classe 100X16E** video internal units, it will be necessary to consider the following:

In **multi-family** systems, the Classe 300EOS video internal unit must be powered locally – clamps (1 – 2), using the additional power supply unit 346020.

Apartment block or multi-family context

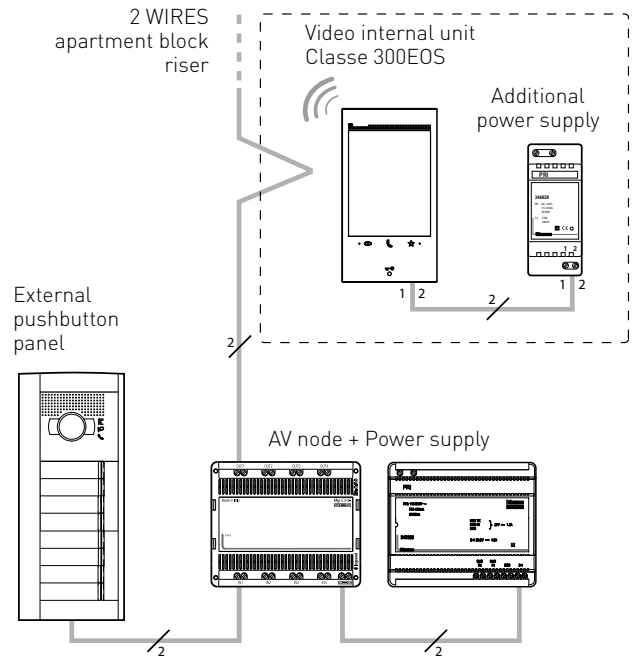

During the commissioning stage, the Classe 300EOS / Classe 100X video internal unit and the smartphone must both be connected to the same Wi-Fi network.

The Wi-Fi network must be on a **2.4 GHz** band.

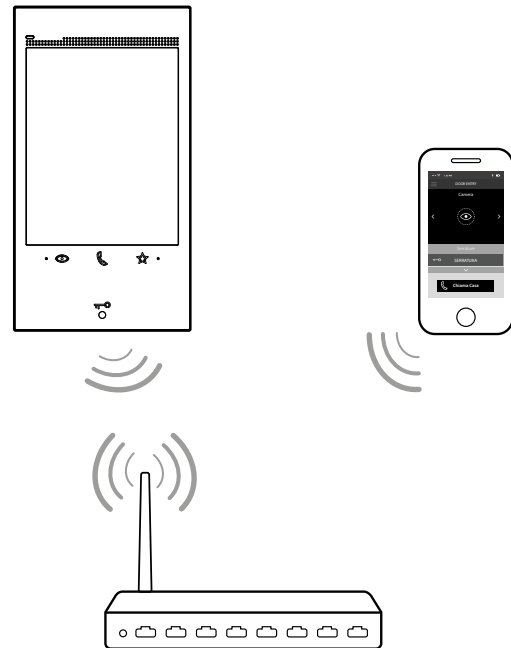

In case of abnormal operation, carry out a troubleshooting procedure, making reference to the **DIAGNOSTIC - TROUBLESHOOTING** section below.

# Diagnostic - Troubleshooting

The troubleshooting procedure must be completed rationally. Before carrying out any operations on the system, check the diagram and the type of system, its extension, that the devices are being used and are configured correctly. With the appropriate splitting into sections, all the systems, even the more complex ones, can be traced back to a basic one to make the activities easier.

## BASIC SYSTEM

2 WIRES audio and video systems can be simplified in line with the following block diagrams.

Legend:

**PE P** = Main entrance panel configured with (P = 0)

**PI** = Audio or video internal unit / apartment interface

**ALIM** = System power supply

**DP** = Video floor shunt

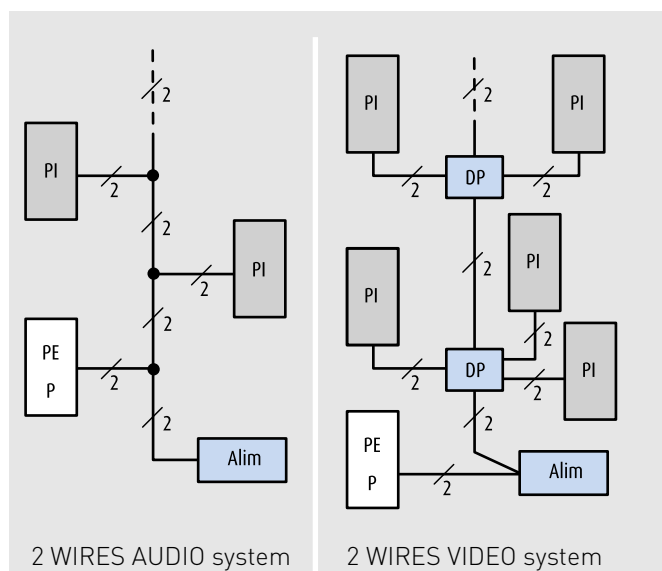

## GENERAL CONTROLS

- Check that the installation distances have been respected and that the recommended cables have been used.
- Check the voltages (with the components connected) on the clamps of the system power supply unit (BUS TK, BUS PI, SCS clamps 346050 – 27 V) or BUS clamps 346040 – 26 V).

If the voltages are different, check the power supply unit without load (no connected components). If the indicated voltages can be measured in this condition, it means that there is a short circuit on the system: separate the system into sections and repeat the checks. If the voltages are still different, check the network power supply and replace the system power supply unit if necessary.

- Check that the devices are working correctly (by connecting them to another point of the system).
- Check that the plug-in clamps are plugged in correctly and in the correct housings.

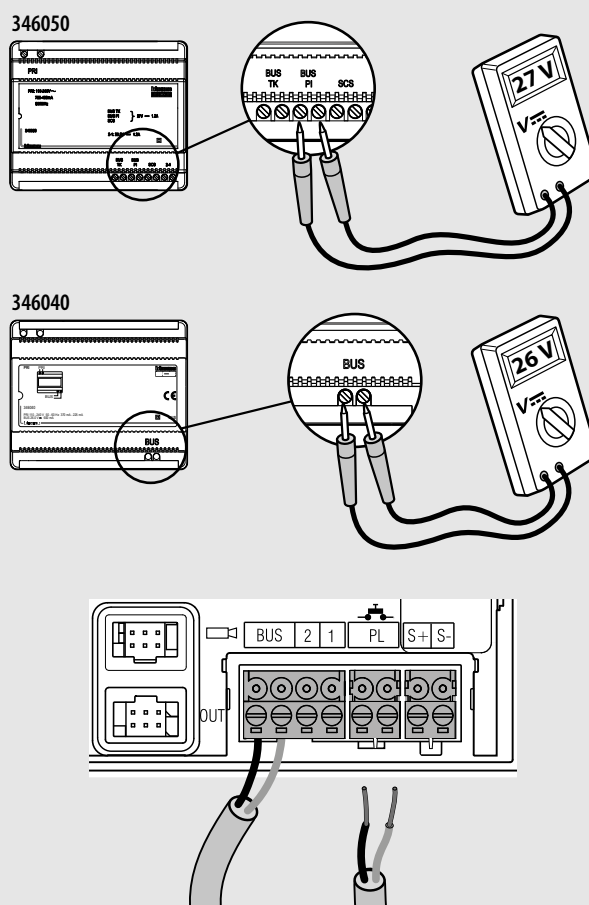

Check that the connections have been completed correctly.

# Diagnostic - Troubleshooting

Below is a list of the most common faults and their solutions.

## TYPE OF FAULT

- The call tone is heard at the entrance panel, but no internal unit rings

## SOLUTION

- Check the EP and IU configuration in **(N)**.
- Check that the configuration is appropriate for the system (presence of apartment interface, system expansion interface, etc.).
- Check that the cables are correctly connected to the power supply BUS clamps.

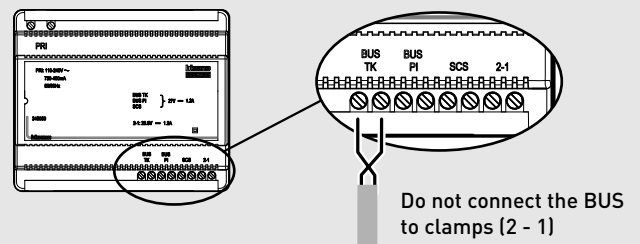

- When using an additional power supply unit (clamps 2 - 1). make sure that the BUS cable is also connected, and that the polarity requirement is met for clamps 2- 1.
- Check the connection order of the entrance panel SFERA module and the corresponding IN - OUT flat cable connections

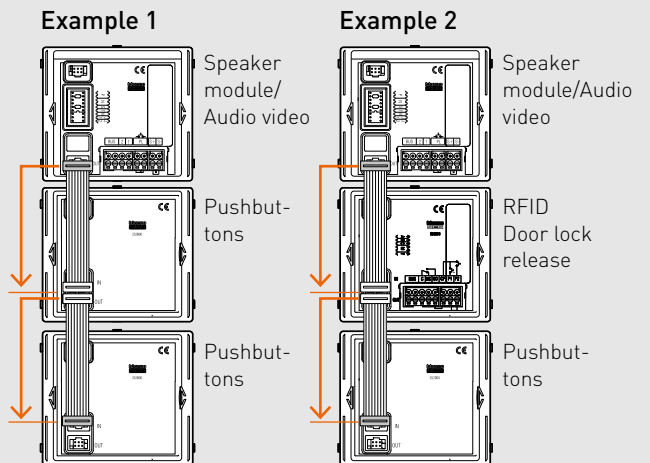

**Caution :** "advanced" function modules (keypad [353000](#) and door opening RFID [353200](#)), must be connected before any pushbutton modules ([352000](#) – [352100](#)) of the system.



## TYPE OF FAULT

- The internal unit does not ring

## SOLUTION

- Check the IU configuration.
- Check that call exclusion is not active and the volume of the ringtone.
- Check the cables connections to the internal unit clamps.

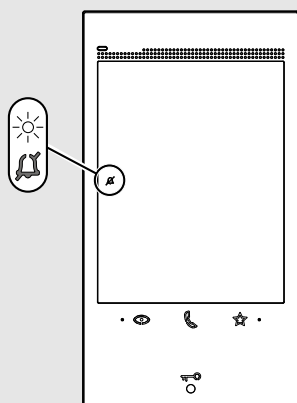

**Class 300E0S**

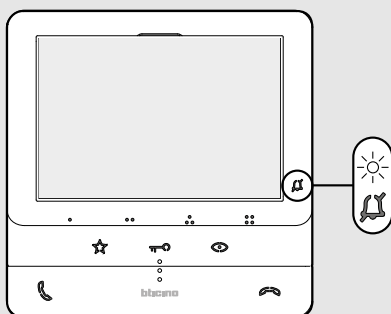

**Class 100X16E  
Class 100V16E**

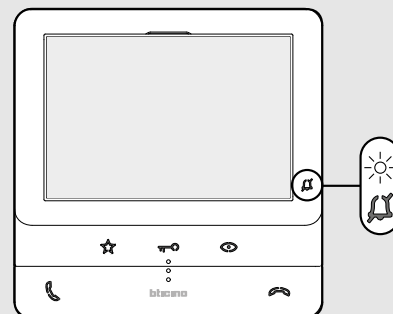

**Class 100V16B**

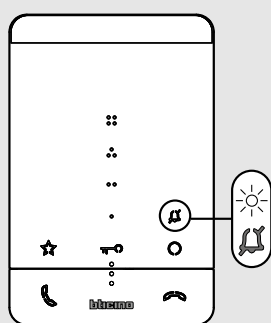

**Class 100A16E**

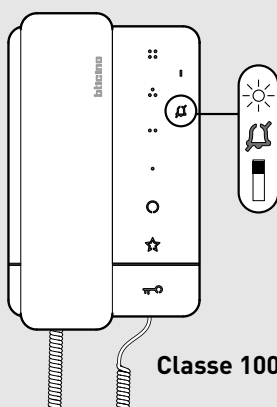

**Class 100A16M**

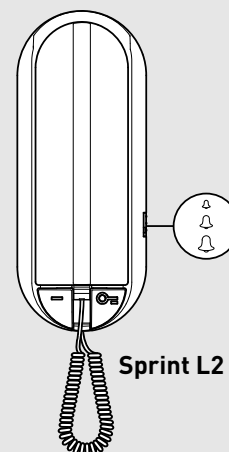

**Sprint L2**

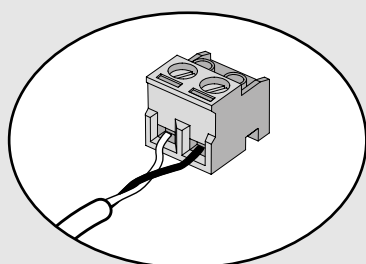

# Diagnostic - Troubleshooting

## TYPE OF FAULT

- The monitor switches on but no image is displayed, or the image quality is poor.

## SOLUTION

- Check that the IU microswitch (**ON – OFF**) is positioned **correctly (ON the last IU of the line)**.
- Check that all system connections and junctions have been completed correctly.
- Check that the entrance panel camera is focused correctly.
- Check that the IU is set to "**MASTER**".
- If using a Sfera entrance panel with wide angle N&D camera (352400), check its connection to the speaker module (351100).
- On the internal unit, check the display brightness, contrast and colour adjustments.
- Check that the maximum distances between entrance panel and internal unit are not exceeded.

- The door lock is excited for too long.

- On the EP speaker module check that the configurator plugged in the (**T**) housing meets the timing requirements, as indicated in the specific technical data sheet.

- In single-family systems with intercom function, when a call is received from the entrance panel not all internal units ring.

- Check that a configurator (**9**) has been plugged to the housing (**S**) of the speaker module of the entrance panel.

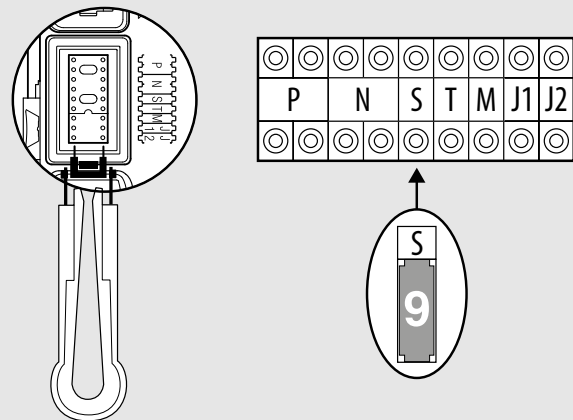

- Check that the internal units are correctly configured in **N**; refer to the connection diagrams found in the guide.

## TYPE OF FAULT

- In single-family systems with intercom function, when call is sent from one internal unit to another, nothing happens.

## SOLUTION

- Check the configuration **M** on the IU. Check that the operating mode assigned to the internal unit keys is consistent with the requested function.

Refer to the specific IU technical sheets.

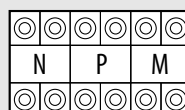

**M = 01**

- **Intercom su se stesso**, invia la chiamata a tutti gli apparecchi con uguale indirizzo
- **Intercom all'interno dell'appartamento** in impianti con interfaccia di appartamento 346850 oppure **intercom tra appartamenti** in impianti senza interfaccia di appartamento
- **Attivazione del PE** (configurato con P+1) in modo diretto senza la chiamata oppure attivazione attuatore 346210 (configurato con P+1 e MOD=9)
- **Apertura serratura del PE** (configurato con P+1) in modo diretto senza la chiamata oppure attivazione attuatore 346210 (configurato con P+1 e MOD=5) oppure attivazione attuatori serratura 346230 - 346260 (configurati con P+1)

**M = 21** Funzioni tasti sopra descritte + **Studio professionale**

**M = 41** Funzioni tasti sopra descritte + **Cerca persone**

**M = 81** Funzioni tasti sopra descritte + **Studio professionale** + **Cerca persone**

- The door lock control does not work

- Check the characteristics and operation of the electric door lock.

- In order to rule out any entrance panel faults, open the door lock using the local pushbutton directly connected to the entrance panel.

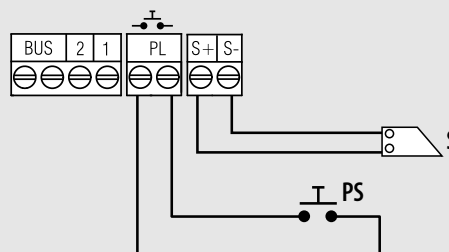

- If this works correctly, check the configuration **(P)** on entrance panels and internal units.

- Check the operation of the door lock with the system **"IDLE"**.

- Check the operation of the door lock with the system **"CONNECTED"**.

# Diagnostic - Troubleshooting

## TYPE OF FAULT

- The actuator **346210** does not work

## SOLUTION

- In order to rule out any actuator faults, send the command using the local control directly connected to the device.

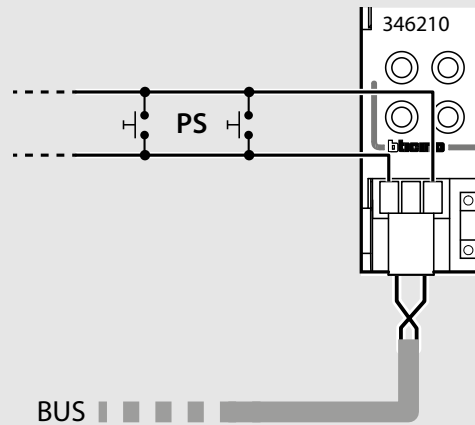

- Check the configuration of the actuator to make sure that it complies with the requirements of the technical data sheet.

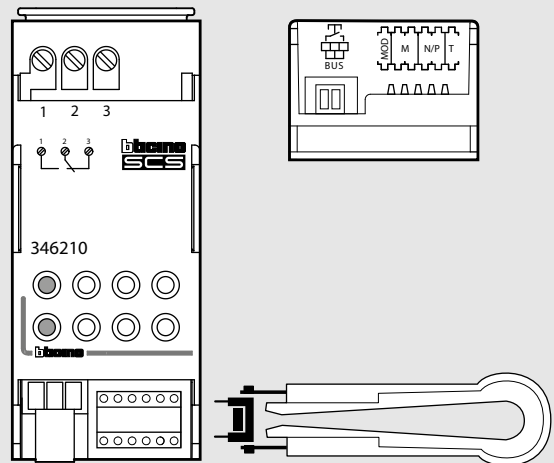

- Check the configuration of the internal unit and that the configurators are correctly plugged into their respective housings.
- Check the BUS wiring.
- Check the voltage on the BUS clamps.

## TYPE OF FAULT

- The actuator [346230](#) does not work

## SOLUTION

- Check the configuration of the actuator to make sure that it complies with the requirements of the technical data sheet.
- Check that the configuration is consistent with the mode of operation of the internal unit and the corresponding key associated to the actuator.
- Check if there is a need for "JMP" configurators, depending on the selected operating mode.

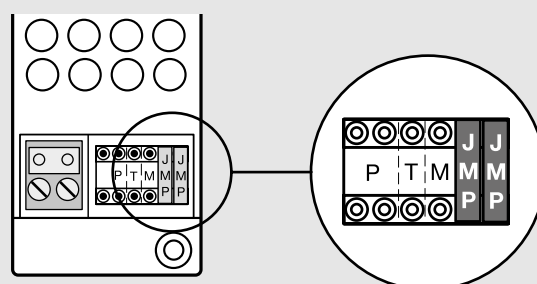

- In video systems with risers and line expansions, the image is degraded and of poor quality.

- Check that on the last internal unit of the apartment riser or line, the video signal impedance has been adapted (microswitch in the ON position).
- Check that the apartment interface ([346850](#)) or the system expansion interface ([346851](#)) have been installed, and the status - video signal level - indicated by the LED 

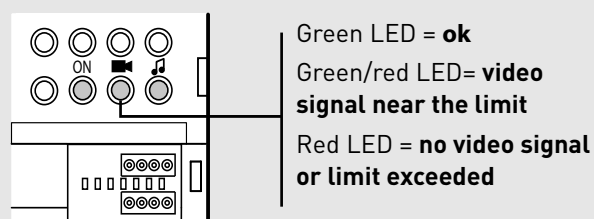

**NOTE :** in the audio systems, the LED is red.

# Diagnostic - Troubleshooting

Systems with  
**Classe 300EOS / Classe 100X16E**  
connected video internal units

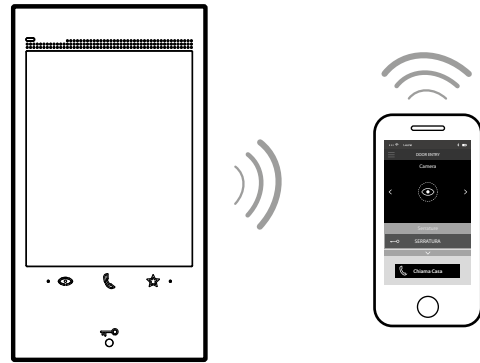

## TYPE OF FAULT

- **No video door entry system call received on the smartphone**
- Red LED flashing = Wi-Fi is active but not connected to a network;
- LED off = working correctly

## SOLUTION

- Check the Wi-Fi signal level on the IU.

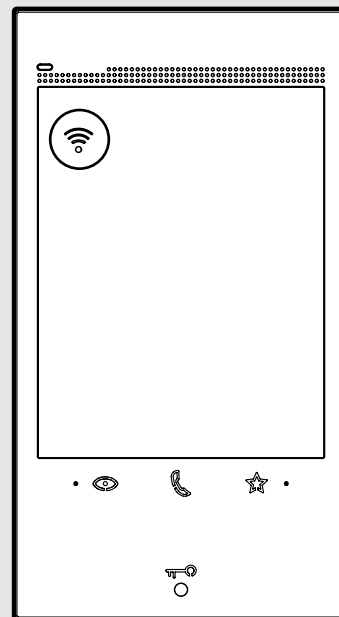

- Check that the router is actually connected to the Internet.
- Check that the date and time of the internal unit are correct.
- Check if any internal unit firmware updates are available.
- Check if any Home + Security APP updates are available.
- Check that PUSH notifications are enabled on your smartphone.



# 5 CATALOGUE

## ENTRANCE PANELS

## Overview and features



	Linea Sfera New	Linea Sfera Robur	Linea 3000
			
Audio	●	●	●
Colour video	●	●	●
Finishes / Colours	Allmetal Allwhite Allstreet	Zamak Robur	Zamak grey Zamak black
Wall mounted installation	●	●	●
Flush mounted installation	●	●	●
Pushbutton call	●	●	●
Digital call	●	●	
Wide angle camera (1)	●	●	●
Night & Day camera (2)	●	●	
Control speech synthesis (3)	●	●	
Door lock release with keypad	●	●	
Door lock release with key card	●	●	●
Rainshield	●	●	●
Vandal proof			
Protection index	IP54	IP54	IP54
Sturdiness index	Up to IK08	IK10	IK10
Max. number of calls	100 with pushbuttons 4000 with digital call	100 with pushbuttons 4000 with digital call	2

(1) Horizontal and vertical wide viewing field. Easy to use for children and differently-abled people.

(2) Night lighting thanks to the IR LED with automatic IR filter. Sharp, perfect images even in limited light conditions.

(3) Inductive loop and control speech synthesis. Use by people wearing hearing aids. Easy to use for visually impaired people.



Linea 2000	Linea 300	Linea 100
		
●		●
Aluminium	Stainless Steel Aluminium	Stainless Steel
●	●	●
●	●	●
●	●	●
		●
		●
	●	
IP54	IP54	IP44
IK07	IK07	IK08
2 (up to 4 calls - audio version only)	32 with pushbuttons 4000 with digital call	8 with pushbuttons 4000 with digital call

## ENTRANCE PANEL

SFERA



SFERA NEW

SFERA ROBUR

# TWO STYLES

## ONE ELECTRONIC HEART

### **2-wires simplicity, maximum performance**

Exceptional audio and video performance as well as fast and simple installation can be achieved with 2-wires technology

- Up to 4000 dwellings
- 20 handsets per dwelling
- Up to 96 video entrance panels
- Operable range of 600 m between entrance panel and internal unit

## 2 DESIGNS

### SFERA NEW

A modern and sleek design suitable for residential and commercial developments.



Audio or video pushbutton entrance panel

Call from address book

### SFERA ROBUR

Sturdy materials and optional flush-mounting boxes providing increased safety and preventing removal of the device



Audio or video pushbutton entrance panel

Digital call



## 12 FUNCTIONS

### TRADITIONAL



Basic speaker module

Speaker module

Audio/video module

4 push-buttons module



8 push-buttons module

Nameplate module

Graphic display module

### ADVANCED



Audio/video wide-angle camera module

Night/day wide-angle camera module

Inductive loop and control speech synthesis module

### DOOR LOCK RELEASE







































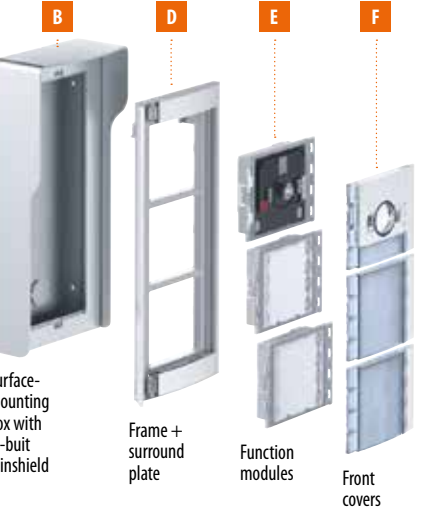



Keypad module













































Badge reader module

# SFERA NEW

## Examples to select parts of the system

FINISHES	INSTALLATION TYPE	FLUSH-MOUNTING BOXES		RAINSHIELDS (OPTIONAL)		FRAMES/PLATES	
		Cat.Nos	Pack	Cat.Nos	Pack	Cat.Nos	Pack
<b>Allmetal (silver)</b>  <b>1</b>	<b>FLUSH-MOUNTING INSTALLATION</b> 	<b>A</b>  <b>350010</b> 1 module	1	<b>C</b>  <b>35051..</b> 1 module	 <b>35054..</b> 4 modules	 <b>35021..</b> 1 module	1
		 <b>350020</b> 2 modules	1	 <b>35052..</b> 2 modules	 <b>352500</b> 6 modules	 <b>35022..</b> 2 modules	1
		 <b>350030</b> 3 modules	1	 <b>35053..</b> 3 modules	 <b>35059..</b> 9 modules	 <b>35023..</b> 3 modules	1
<b>Allwhite (white)</b>  <b>2</b>	<b>FLUSH-MOUNTING INSTALLATION</b> 	<b>A</b>  <b>350010</b> 1 module	1	<b>C</b>  <b>35051..</b> 1 module	 <b>35054..</b> 4 modules	 <b>35021..</b> 1 module	1
		 <b>350020</b> 2 modules	1	 <b>35052..</b> 2 modules	 <b>352500</b> 6 modules	 <b>35022..</b> 2 modules	1
		 <b>350030</b> 3 modules	1	 <b>35053..</b> 3 modules	 <b>35059..</b> 9 modules	 <b>35023..</b> 3 modules	1
<b>Allstreet (grey)</b>  <b>3</b>	<b>SURFACE-MOUNTING INSTALLATION</b> 	<b>B</b>  <b>35061..</b> 1 module	1	<b>B</b>  <b>35064..</b> 4 modules	 <b>35066..</b> 6 modules	 <b>35021..</b> 1 module	1
		 <b>35062..</b> 2 modules	1	 <b>35066..</b> 6 modules	 <b>35066..</b> 6 modules	 <b>35022..</b> 2 modules	1
		 <b>35063..</b> 3 modules	1	 <b>35069..</b> 9 modules	 <b>35069..</b> 9 modules	 <b>35023..</b> 3 modules	1











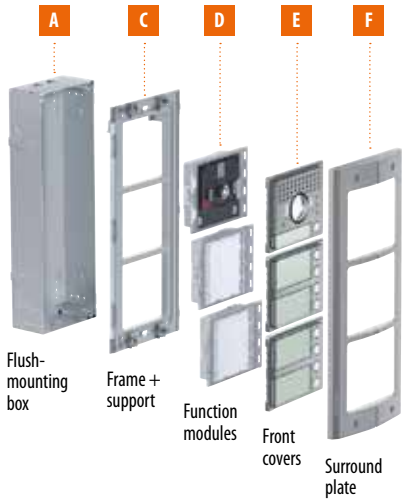









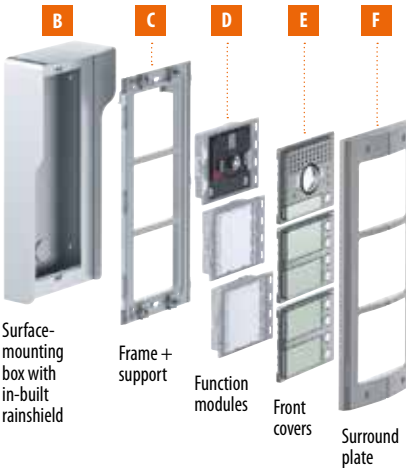

CHOOSE YOUR FINISH: Replace the dots in the Cat. No. with either 1, 2, or 3 to select the desired finish

		DIGITAL FUNCTION MODULES		FRONT COVERS							
		Cat.Nos	Pack	Cat.Nos					Pack		
Speakers	E	 <b>351000</b> Basic speaker module (FOR AUDIO SYSTEMS ONLY)	1	F Audio front covers					1		
				 <b>35100..</b> Basic speaker module	 <b>35101..</b> Basic speaker module 1 push-button	 <b>35102..</b> Basic speaker module 2 push-buttons	 <b>35104..</b> Basic speaker module 2 push-buttons/double row	 <b>35108..</b> Basic speaker module 4 push-buttons/double row			
		 <b>351100</b> Speaker module	1	 <b>35110..</b> Speaker module	 <b>35111..</b> Speaker module 1 push-button	 <b>35112..</b> Speaker module 2 push-buttons	 <b>35114..</b> Speaker module 2 push-buttons/double row	 <b>35118..</b> Speaker module 4 push-buttons/double row	1		
Push-buttons	E	 <b>352000</b> 4 push-buttons/ single row	1	 <b>35203..</b> 3 push-buttons	 <b>35204..</b> 4 push-buttons	 <b>352011</b> 1 push-button	 <b>352021</b> 2 push-buttons	1			
				 <b>352100</b> 8 push-buttons/ double row	 <b>35216..</b> 6 push-buttons/double row	 <b>35218..</b> 8 push-buttons/double row	 <b>352121</b> 2 push-buttons/double row		 <b>352141</b> 4 push-buttons/double row		
Cameras	E	 <b>351200</b> Audio/video	1	 <b>35120..</b> Audio/video	 <b>35121..</b> Audio/video 1 push-button	 <b>35122..</b> Audio/video 2 push-buttons/double row	1				
				 <b>351300</b> Audio/video with wide angle camera	 <b>35130..</b> Audio/video wide angle	 <b>35131..</b> Audio/video wide angle 1 push-button		 <b>35132..</b> Audio/video wide angle 2 push-buttons / double row	 <b>354000</b> Cable for the connection or several push-button modules L= 470 mm		
				 <b>352400</b> Night/day with wide angle camera	 <b>35240..</b> Night/day with wide angle camera						
Miscellaneous	E	 <b>352200</b> Name plate	1	F Miscellaneous front covers			1				
				 <b>35220..</b> Name plate							
				 <b>352500</b> Graphic display	 <b>35250..</b> Graphic display						
				 <b>352700</b> Inductive loop and control speech synthesis	 <b>35270..</b> Inductive loop-speech synthesis						
				 <b>353200</b> Badge reader	 <b>35320..</b> Badge reader						
		 <b>353000</b> Keypad	1	 <b>35300..</b> Numeric keypad	 <b>353011</b> Alphanumeric keypad			1			



































CHOOSE YOUR FINISH: Replace the dots in the Cat. No. with either 1, 2, or 3 to select the desired finish

# SFERA ROBUR

## Examples to select parts of the system

FINISHES	INSTALLATION TYPE	FLUSH-MOUNTING BOXES		SUPPORT FRAMES		FRAMES/PLATES	
	FLUSH-MOUNTING INSTALLATION	Cat.Nos	Pack	Cat.Nos	Pack	Cat.Nos	Pack
<b>Vandal-resistant (ROBUR)</b> 	 <p>Flush-mounting box</p> <p>Frame + support</p> <p>Function modules</p> <p>Front covers</p> <p>Surround plate</p>	<p><b>A</b></p>  <p><b>350110</b> 1 module</p>  <p><b>350120</b> 2 modules</p>  <p><b>350130</b> 3 modules</p>	<p>1</p> <p>1</p> <p>1</p>	<p><b>C</b></p>  <p><b>350315</b> 1 module</p>  <p><b>350325</b> 2 modules</p>  <p><b>350335</b> 3 modules</p>	<p>1</p> <p>1</p> <p>1</p>	<p><b>D</b></p>  <p><b>350415</b> 1 module</p>  <p><b>350425</b> 2 modules</p>  <p><b>350435</b> 3 modules</p>	<p>1</p> <p>1</p> <p>1</p>
	INSTALLATION TYPE	SURFACE-MOUNTING BOXES		SUPPORT FRAMES		FRAMES/PLATES	
	SURFACE-MOUNTING INSTALLATION	Cat.Nos	Pack	Cat.Nos	Pack	Cat.Nos	Pack
	 <p>Surface-mounting box with in-built rainshield</p> <p>Frame + support</p> <p>Function modules</p> <p>Front covers</p> <p>Surround plate</p>	<p><b>B (*)</b></p>  <p><b>35061..</b> 1 module</p>  <p><b>35062..</b> 2 modules</p>  <p><b>35063..</b> 3 modules</p>  <p><b>35064..</b> 4 modules</p>  <p><b>35066..</b> 6 modules</p>  <p><b>35069..</b> 9 modules</p>	<p>1</p> <p>1</p> <p>1</p>	<p><b>C</b></p>  <p><b>350315</b> 1 module</p>  <p><b>350325</b> 2 modules</p>  <p><b>350335</b> 3 modules</p>	<p>1</p> <p>1</p> <p>1</p>	<p><b>D</b></p>  <p><b>350415</b> 1 module</p>  <p><b>350425</b> 2 modules</p>  <p><b>350435</b> 3 modules</p>	<p>1</p> <p>1</p> <p>1</p>

(\*) CHOOSE YOUR FINISH: Replace the dots in the Cat. No. with either 1, 2, or 3 to select the desired finish - Refer to SFERA NEW finishes.

	DIGITAL FUNCTION MODULES		FRONT COVERS					
	Cat.Nos	Pack	Cat.Nos					Pack
Speakers	<b>E</b>  <b>351000</b> Basic speaker module (FOR AUDIO SYSTEMS ONLY)	1	<b>F</b> <b>Audio front covers</b>					
	 <b>351100</b> Speaker module	1	 <b>351005</b> Basic speaker module	 <b>351015</b> Basic speaker module 1 push-button	 <b>351025</b> Basic speaker module 2 push-buttons	 <b>351045</b> Basic speaker module 2 push-buttons/double row	 <b>351085</b> Basic speaker module 4 push-buttons/double row	1
Push-buttons	 <b>352000</b> 4 push-buttons/ single row	1	 <b>352035</b> 3 push-buttons	 <b>352045</b> 4 push-buttons				1
	 <b>352100</b> 8 push-buttons/ double row	1	 <b>352165</b> 6 push-buttons/double row	 <b>352185</b> 8 push-buttons/double row				1
	<b>E</b>		<b>F</b> <b>Video front covers</b>					
	Cameras	 <b>351200</b> Audio/video	1	 <b>351205</b> Audio/video	 <b>351215</b> Audio/video 1 push-button	 <b>351225</b> Audio/video 2 push-buttons / double row		
 <b>351300</b> Audio/video with wide angle camera		1	 <b>351305</b> Audio/video wide angle	 <b>351315</b> Audio/video wide angle 1 push-button	 <b>351325</b> Audio/video wide angle 2 push-buttons / double row	 <b>354000</b> Cable for the connection or several push-button modules L= 470 mm		1
 <b>352400</b> Night/day with wide angle camera		1	 <b>352405</b> Night/day with wide angle camera					1
Miscellaneous	<b>E</b>		<b>F</b> <b>Miscellaneous front covers</b>					
	 <b>352200</b> Name plate	1	 <b>352205</b> Name plate					1
	 <b>352500</b> Graphic display	1	 <b>352505</b> Graphic display					1
	 <b>352700</b> Inductive loop and control speech synthesis	1	 <b>352705</b> Inductive loop-speech synthesis					 <b>352305</b> Blanking reader
	 <b>353200</b> Badge reader	1	 <b>353205</b> Badge reader					
 <b>353000</b> Keypad	1	 <b>353005</b> Keypad					1	

# SFERA

## Electronic modules



351000



351100



351200



351300



352000



352100



352200

Pack	Item	Electronic modules
1	351000	<b>Basic speaker module</b> for the creation of 2 WIRE audio systems. Fitted with loudspeaker and microphone volume adjustment. It manages up to 100 pushbutton calls using additional double row pushbuttons. It can be used for opening an electrical door lock directly connected to the S+ and S- clamps (18 V 4 A impulsive - 250 mA holding current 30 Ohm max) and the connection to a local door lock release pushbutton on the PL clamps. To be completed with surround plate. The device must be physically configured.
1	351100	<b>Speaker module</b> for the creation of 2 WIRE audio & video systems. Fitted with loudspeaker and microphone volume adjustment. It can manage up to 100 pushbutton calls when using additional double row pushbutton modules. It can be used for opening an electrical door lock directly connected to the S+ and S- clamps (18 V 4 A impulsive - 250 mA holding current 30 Ohm max) and the connection to a local door lock release pushbutton on the PL clamps. Preset for additional power supply. Fitted with front LEDs for the notification of the operating status: door lock release, communication active, call put through, and system busy. Integrated optic sensor for the switching on of the night backlighting. To be completed with surround plate. The device can be configured either physically or using the PC and the TiSferaDesign software.
1	351200	<b>Audio video module</b> for the installation of 2 WIRE colour video systems. With Colour camera with 1/3" sensor and white LEDs for the lighting of the shooting field. Mist prevention heating resistance. Loudspeaker and Microphone volume adjustments. It can manage up to 98 pushbutton calls using the additional double row pushbutton modules. Horizontal and vertical camera position adjustment, +/- 10° in both directions. It offers the possibility of opening an electrical door lock directly connected to clamps S+ and S- (18 V 4 A impulsive - 250 mA holding current 30 Ohm max) and of connecting a local door lock release pushbutton on clamps PL. Preset for additional power supply. Fitted with front LEDs for the notification of the operating status: door lock release, communication active, call put through, and system busy. Integrated optic sensor for the switching on of the night backlighting. To be completed with surround plate. The device must be configured physically or using a PC and the TiSferaDesign software.

Pack	Item	Electronic modules
1	351300	<b>Wide angle audio/video module</b> for the installation of 2 WIRE colour video systems. With Colour camera with 1/3" sensor and white LEDs for the lighting of the shooting field. Mist prevention heating resistance. Loudspeaker and Microphone volume adjustments. It can manage up to 98 pushbutton calls using the additional double row pushbutton modules. It offers the possibility of opening an electrical door lock directly connected to clamps S+ and S- (18 V 4 A impulsive - 250 mA holding current 30 Ohm max) and of connecting a local door lock release pushbutton on clamps PL. Preset for additional power supply. Fitted with front LEDs for the notification of the operating status: door lock release, communication active, call put through, and system busy. Integrated optic sensor for the switching on of the night backlighting. To be completed with surround plate. The device must be configured physically or using a PC and the TiSferaDesign software
1	352000	<b>Additional 4-pushbutton modules arranged on single column.</b> To be used with speaker modules 351000 - 351100 and audio/video modules 351200 - 351300. Connection using the appropriate multicable supplied. Backlighting of nameplates controlled by the speaker module or the audio/video module connected. To be completed with surround plate
1	352100	<b>Additional 8-pushbutton modules arranged on double column.</b> To be used with speaker modules 351000 - 351100 and audio/video modules 351200 - 351300. Connection using the appropriate multicable supplied. Backlighting of nameplates controlled by the speaker module or the audio/video module connected. To be completed with surround plate
1	352200	<b>Nameplate module</b> normally used for displaying the house number or other notifications (e.g. Legend for calls using digital pushbutton panels, opening/closing times, etc.). Connection using the appropriate multicable supplied. Night backlighting controlled by the speaker module or the audio/video module connected. To be completed with surround plate





Pack	Item	Electronic modules
1	352400	<b>Night &amp; Day and wide angle camera module</b> for the installation of colour video systems. Fitted with 1/3" sensor with N&D function and automatic removal of the IR filter. IR LED for the lighting of the field of view. Mist prevention heating resistance. Automatic brightness adjustment. Connection to the speaker module (351100) using the multicable supplied. To be completed with surround plate
1	352500	<b>Graphic display module</b> to be used with speaker module 351100 or with audio/video modules 351200 - 351300 (connection using the multicable supplied). It can operate in two modes: call from address book, or digital call. The call from the address book gives the possibility of sending the call by scrolling on the display the names associated to the residents. It is possible to store up to 4000 residents names. Using the keypad module item 353000 it is also possible to directly call the apartment by entering the number corresponding to the resident. The digital call is also performed using the keypad module item 353000 by entering the numerical code. It is recommended that one or more nameplate modules, item 352200, are installed at the side of the pushbutton panel to display the correspondence between the numerical codes and the names of the users. It is possible to program the names in the address book in two different ways: manual inclusion using the pushbuttons of the display module or inclusion using a PC with the TiSferaDesign software installed, by downloading the file to the display module (RECOMMENDED). System power supply cuts do NOT cause the loss of memory data. To be completed with surround plate
1	352700	<b>Inductive loop and control speech synthesis module</b> to be used with the 351100 speaker module or with audio/video modules 351200 - 351300. Enable use by people wearing hearing aids (fitted with T selector) or blind people thanks to the connection status voice message synthesis (call active, call ended, no answer, busy, door open). It is connected to the speaker module using the appropriate multicable supplied. To be completed with surround plate. The device can be configured either physically or using the PC and the TiSferaDesign software

Pack	Item	Electronic modules
1	353000	<b>Keypad module</b> for door lock release, or for the digital call of the apartment (to be used with the display module). It is fitted with relay with contacts (C - NC - NO) and clamps (CP- P1 - P2) for the connection of a local door lock release pushbutton. The numerical code for the opening of the door lock can be programmed using the keypad itself, or using a PC after downloading the module programming file. It also has a programming reset pushbutton and LEDS for the visual notification of the access status. Night backlighting with LEDs. To be completed with surround plate. It is connected to the other modules using the appropriate multicable supplied. The device may also be used as a stand alone unit with independent power supply and operation per la sola apertura serratura. Configuration performed using physical configurators, or a PC with the TiSferaDesign software installed
1	353200	<b>RFID badge reader module</b> for the release of the door lock by swiping the badge. It manages up to 20000 badges. It's fitted with relay contacts (C - NO - NC) and clamps (CP - P1 - P2) for the connection of a local door release pushbutton. The badge for the release of the door lock can be programmed from the module itself, or using a PC after downloading the module programming file. It also has a programming reset pushbutton and LEDS for the visual notification of the access status. Night backlighting a LEDs. To be completed with surround plate. It is connected to the other modules using the appropriate multicable supplied. The device may also be used as a stand alone unit with independent power supply and operation. Configuration performed using physical configurators, or a PC with the TiSferaDesign software installed
1	346993	<b>Expander pushbutton module</b> that gives the possibility of connecting call pushbuttons to the SFERA speaker modules (items 351000; 351100; 351200; 351300). Each module can manage up to 8 call pushbuttons. It is possible to connect several expander pushbutton modules (max 96 call pushbuttons for each Entrance Panel)

Pack	Item	Transponder keys and programmer
10	348200	Black transponder key
10	348201	Red transponder key
10	348202	Green transponder key
10	348203	Blue transponder key
10	348204	Orange transponder key
10	348205	Grey transponder key
10	348206	Yellow transponder key
1	348402	Table-top transponder key programmer

# LINEA 3000 entrance panel

## ONE entrance panel for every NEED

LINEA 3000 can be configured both for 1 and 2 family house



### ONE FAMILY HOUSE

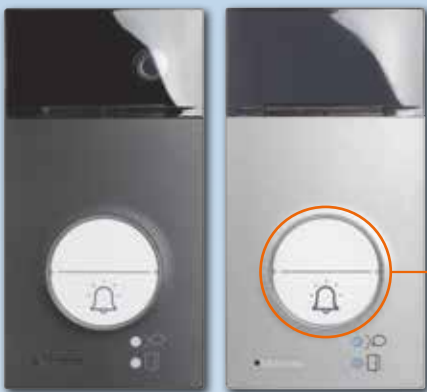

- Write the name on the one family nameplate label (supplied with the product).
- Set the internal micro-switch on position 1.

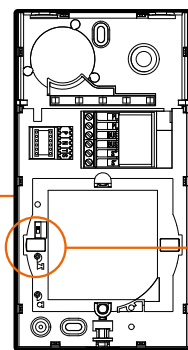
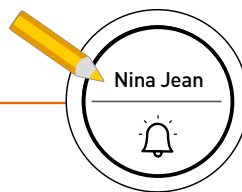

### TWO FAMILY HOUSE



- Replace the nameplate label with the two family one (supplied with the product).
- Write the names on the two family nameplate label
- Set the internal micro-switch on position 2.

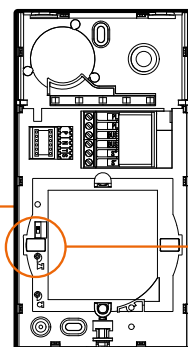
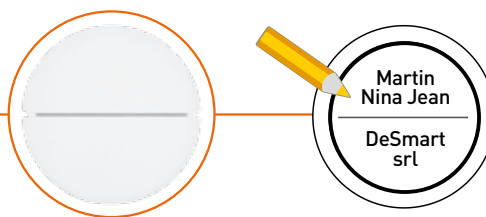

### LINEA 3000 inside of the new professional kits

For **ONE FAMILY** house installation, you have to buy only the kit and all you need is inside it.

For **TWO FAMILY** house installation, you have to buy the kit + an additional 2 wires internal unit. (refer to 2 wires system internal units range).



# HIGH installation flexibility

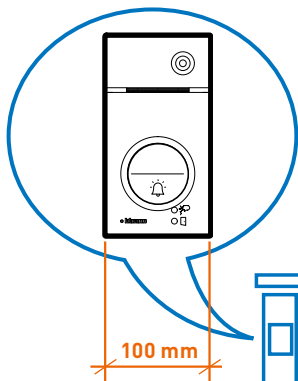

100 mm width  
Suitable for **POLE INSTALLATION**

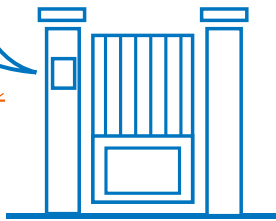

**LINEA 3000** is sold for wall mounting installation but with the dedicated **ACCESSORIES** (to be purchased separately), you can use the entrance panel for **FLUSH MOUNTING INSTALLATION**.

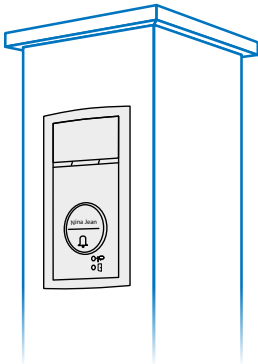

Also available in black version.

Ideal for renovations.....you can reuse the existing flush mounted box.  
Same 2 Modules Tersystem and SFERA flush mounting box.

**LINEA 3000** can be wall mounted with the dedicated **(343051) RAINSHIELD ACCESSORY** (to be purchased separately).

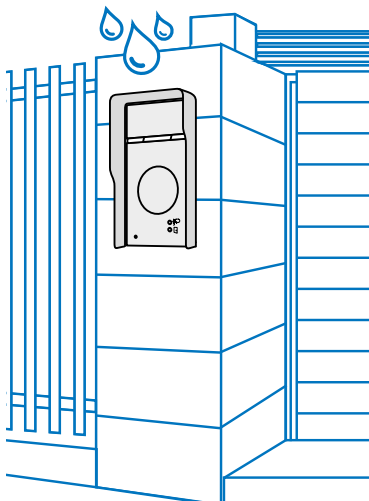

Also available in black version.

# LINEA 3000 entrance panel

## The entrance panels range dedicated to VILLA STANDARD

HIGH LEVEL APPLICATIONS



**branded**  
quality

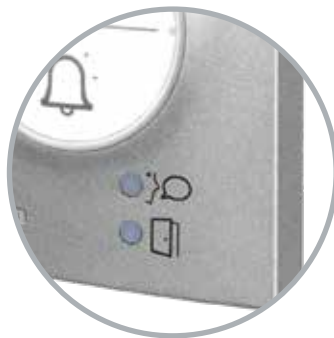

**refined**  
detailing

**Modern aesthetics**  
feeling of quality



**floating**  
effect



**hidden**  
technology



**high relevance**  
on interaction

**robustness**  
Zamak finishes



Weatherproof  
(IP 54) protection degree



Robustness  
(IK 10) protection degree

# Unique DESIGN and robust PERCEPTION

Same look and ergonomics for all available versions:



**343093**



**343091**

**LINEA 3000** video with door lock release badge



**343081**

**LINEA 3000** video



**343071**

**LINEA 3000** audio

## Advanced FUNCTIONS

### Wide angle camera

Horizontal and vertical wide viewing field. Easy to use for children and differently-abled People.



### Door lock release

Door lock release with coloured badges or clear discs. Additional safe and comfort for all the residents.



# ENTRANCE PANEL

## LINEA 3000



343091



343093



343081



343071



348260



348261

Pack	Item	LINEA 3000 Video entrance panel with door lock release proximity reader
1	343091	Wall mounted 2-Wires video pushbutton panel with Zamak front cover, wide angle colour camera and proximity reader. Fitted with white LED for the lighting of the shooting field in low light conditions. Can be set up for one or two family installation. It provides the possibility of opening an electrical door lock connected directly to clamps S+ and S- (18 V 4 A impulsive, 250 mA holding current, 30 ohm max). Can manage a maximum of 20 badges (125 KHz) for electrical door opening (master system badge included). White LED backlight name plate. Protection degree IP54 – protection against mechanical impact IK10. Supplied 1 set of door opening badges made up of : 6 coloured badges and 2 clear discs.
1	343093	Same as 343091 but in black finish

1	343081	<b>LINEA 3000 Video entrance panel</b> Wall mounted 2-Wires video pushbutton panel with Zamak front cover and wide angle colour camera.. Fitted with white LED for the lighting of the shooting field in low light conditions. Can be set up for one or two family installation. It provides the possibility of opening an electrical door lock connected directly to clamps S+ and S- (18 V 4 A impulsive, 250 mA holding current, 30 ohm max). White LED backlight name plate. Protection degree IP54 – protection against mechanical impact IK10.
---	--------	---

1	343071	<b>LINEA 3000 Audio entrance panel</b> Wall mounted 2-Wires pushbutton panel with Zamak front cover. Can be set up for one or two family installation. It provides the possibility of opening an electrical door lock connected directly to clamps S+ and S- (18 V 4 A impulsive, 250 mA holding current, 30 ohm max). White LED backlight name plate. Protection degree IP54 – protection against mechanical impact IK10.
---	--------	---

Pack	Item	LINEA 3000 Spare part front covers
1	343082	Spare part front cover for video entrance panels 343081 and 343091.
1	343072	Spare part front cover for audio entrance panel 343071.
<b>Door lock release badge and clear disc</b>		
1	348260	Set made up of 6 coloured badges which can be programmed to open the door
1	348261	Set made up of 2 programmable clear discs which can be programmed to open the door



Pack	Item	LINEA 3000 Rainshield accessory
1	343051	Rainshield roof accessory for Linea 3000 (343071 - 343081 - 343091) entrance panels. To be purchased separately.
1	343053	Rainshield roof accessory for Linea 3000 (343093) entrance panel. To be purchased separately.

Pack	Item	LINEA 3000 Flush mounting accessory + plastic box
1	343061	Flush mounting frame accessory for Linea 3000 (343071 - 343081 - 343091) entrance panels. To be purchased separately.
1	343063	Flush mounting frame accessory for Linea 3000 (343093) entrance panel. To be purchased separately.
1	350020	Plastic box suitable for the flush mounting installation of Linea 3000 entrance panels (343071 - 343081 - 343091 - 343093) together with the specific frame accessory 343061 - 343063. To be purchased separately.



# ENTRANCE PANEL

## LINEA 2000



343031



343032



342911



342921



342931



342941

Pack	Item	Wall mounted colour video entrance panel
1	<a href="#">343031</a>	2 WIRE video pushbutton panel with a call key and colour camera. Fitted with white LEDs for the lighting of the shooting field in low light conditions. Aluminium front cover. Nameplate lit by green LED
1	<a href="#">343032</a>	As item <a href="#">343031</a> , but with 2 call pushbuttons

Pack	Item	Wall mounted audio entrance panel
1	<a href="#">342911</a>	2 WIRE audio pushbutton panel with one call pushbutton for wall mounted installation. Aluminium front cover. Nameplate lit by green LED
1	<a href="#">342921</a>	As item <a href="#">342911</a> , but with 2 call pushbuttons
1	<a href="#">342931</a>	As item <a href="#">342911</a> , but with 3 call pushbuttons
1	<a href="#">342941</a>	As item <a href="#">342911</a> , but with 4 call pushbuttons





LINEA 100



343101



343102



343100

Pack	Item	Pushbuttons audio entrance panel
1	343101	2 WIRE audio pushbutton panel with 4 call pushbuttons for wall mounted installation. It's fitted with rainshield and internal contact (C - NO - NC) for the connection of an electrical door lock or external actuator (for the power supply to the electrical door lock allow for the installation of auxiliary transformer item 336482). Connections (PL) for a local door lock release pushbutton
1	343102	2 WIRE audio pushbutton panel with 8 call pushbuttons for wall mounted installation. It's fitted with rainshield and internal contact (C - NO - NC) for the connection of an electrical door lock or external actuator (for the power supply to the electrical door lock allow for the installation of auxiliary transformer item 336482). Connections (PL) for a local door lock release pushbutton

Pack	Item	Digital call audio entrance panel
1	343100	2 WIRE AUDIO digital call pushbutton panel for wall mounted installation. The device consists of a pushbutton panel with 16 keys and a digital display showing the operating status. Using previously saved numerical (SCS addresses) or alphanumeric (logical addresses) codes, it is possible to call the internal units, and for the residents to release the door lock using a dedicated numerical code. The pushbutton panel manages up to 4000 internal unit addresses (from 0 to 3999), as well as the direct call to the 2 WIRE switchboard. It's fitted with rainshield and internal contact (C - NO - NC) for the connection of an electrical door lock or external actuator (for the power supply to the electrical door lock allow for the installation of auxiliary transformer item 336482). Connections (PL) for a local door lock release pushbutton



# ENTRANCE PANEL

## LINEA 300

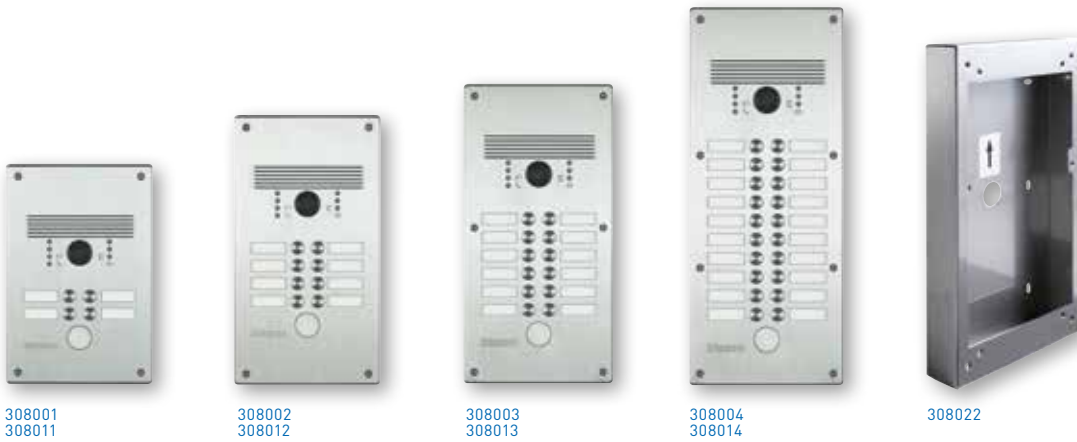

Pack	Item	Aluminium finish pushbutton panel
1	<a href="#">308001</a> <a href="#">308011</a>	Monobloc vandal-resistant 2 WIRE video pushbutton panel for 2 and 4 calls with aluminium finish. The item code includes: flush mounted box, frame, colour video and audio electronic module, prewired pushbutton module/s. Presetting for the mounting of transponder reader or key switch. Backlit call keys. Visual and sound notifications of the communication status for: call active, system busy, door lock status
1	<a href="#">308002</a>	As item <a href="#">308001</a> but for up to 8 calls
1	<a href="#">308003</a>	As item <a href="#">308001</a> but for up to 12 calls
1	<a href="#">308004</a>	As item <a href="#">308001</a> but for up to 20 calls
1	<a href="#">308005</a>	As item <a href="#">308001</a> but for up to 32 calls

Pack	Item	Stainless steel finish pushbutton panel
1	<a href="#">308011</a>	Monobloc vandal-resistant 2 WIRE video pushbutton panel for 2 and 4 calls with stainless steel finish. The item code includes: flush mounted box, frame, colour video and audio electronic module, prewired pushbutton module/s. Presetting for the mounting of transponder reader or key switch. Backlit call keys. Visual and sound notifications of the communication status for: call active, system busy, door lock status
1	<a href="#">308012</a>	As item <a href="#">308011</a> but for up to 8 calls
1	<a href="#">308013</a>	As item <a href="#">308011</a> but for up to 12 calls
1	<a href="#">308014</a>	As item <a href="#">308011</a> but for up to 20 calls
1	<a href="#">308015</a>	As item <a href="#">308011</a> but for up to 32 calls

Pack	Item	Wall mounted boxes
1	<a href="#">308021</a>	Wall mounted box for pushbutton panels, items <a href="#">308001-308011</a>
1	<a href="#">308022</a>	Wall mounted box for pushbutton panels, items <a href="#">308002-308012</a>
1	<a href="#">308023</a>	Wall mounted box for pushbutton panels, items <a href="#">308003-308013</a>
1	<a href="#">308024</a>	Wall mounted box for pushbutton panels, items <a href="#">308004-308014</a>
1	<a href="#">308025</a>	Wall mounted box for pushbutton panels, items <a href="#">308005-308015</a>

NOTA: (\*) compatibilità con scatole da incasso 331120 - 331130



308040



308026



Pack	Item	Digital call entrance panel
1	308040	Monobloc vandal-resistant 2 WIRE digital call video pushbutton panel (in stainless steel), flush mounted or wall mounted installation (with specific box item 308026 sold separately). The item includes: flush mounted vandal-resistant steel box, audio and video module with wide angle colour camera, integrated graphic display, and alphanumeric keypad for direct apartment call, fast address book search, and door lock release using a code. Presetting for the installation of a T25 Vigik reader, or a key switch. Backlit display and BLUE keys. It is possible to store up to 4000 residents names. Visual, sound, or control speech synthesis communication status notification, for example: call active, system busy, door lock status. Direct control of an electric door lock 18V-4A impulsive, 250 mA holding current (30 ohm max). System power supply cuts do NOT cause the loss of memory data. Selectable display menu languages are: Italian, English and French. The device can be configured physically or using a PC with the specific software, which can be downloaded free of charge from <a href="http://www.homesystems-legrandgroup.com">www.homesystems-legrandgroup.com</a>
1	308026	Wall mounted box for digital call entrance panel 308040

# INTERNAL UNITS

## Overview and features

	Classe 300EOS with Netatmo	Classe 100X16E	Classe 100V16E
			
Audio			
Colour video	●	●	●
Handsfree	●	●	●
Call redirection on smartphone	●	●	
Integrated Alexa voice assistant	●		
Wifi connection	●	●	
Finishes / Colours	White	White	White
Display	LCD Touch 5"	LCD 5"	LCD 5"
Answering machine	●		
Floor call	●	●	●
Door lock release	●	●	●
Staircase light control	●	●	●
Scrolling EP activation	●	●	●
Intercom (1)	●	●	●
Inductive loop (2)	●	●	●
Professional studio function	●	●	●
Safe door lock function	●	●	●
Note / message function	●		
Quick link / Favourite	●		
Wall-mounted installation	●	●	●
Tabletop installation		●	●

(1) The intercom function allows for up to 3-minute communication between and among video door entry systems in the same apartment / in different apartments.

(2) Use by people wearing hearing aids fitted with (T) selector.

(3) Activated with specific configuration inserted in P.

	Classe 100V16B	Classe 100V16M	Classe 100A16E	Classe 100A16M	Sprint L2
					
			•	•	•
	•	•			
	•		•		
	White	White	White	White	White
	LCD 5"	LCD 4,3"			
	•	•	•	•	•
	•	•	•	•	•
	•	•	•	•	• (3)
	•	•	•	•	• (3)
	•	•	•	•	
			•	•	
	•	•	•	•	
		•			
	•	•	•	•	•
	•		•	•	

# INTERNAL UNITS

## CLASSE 300EOS with Netatmo

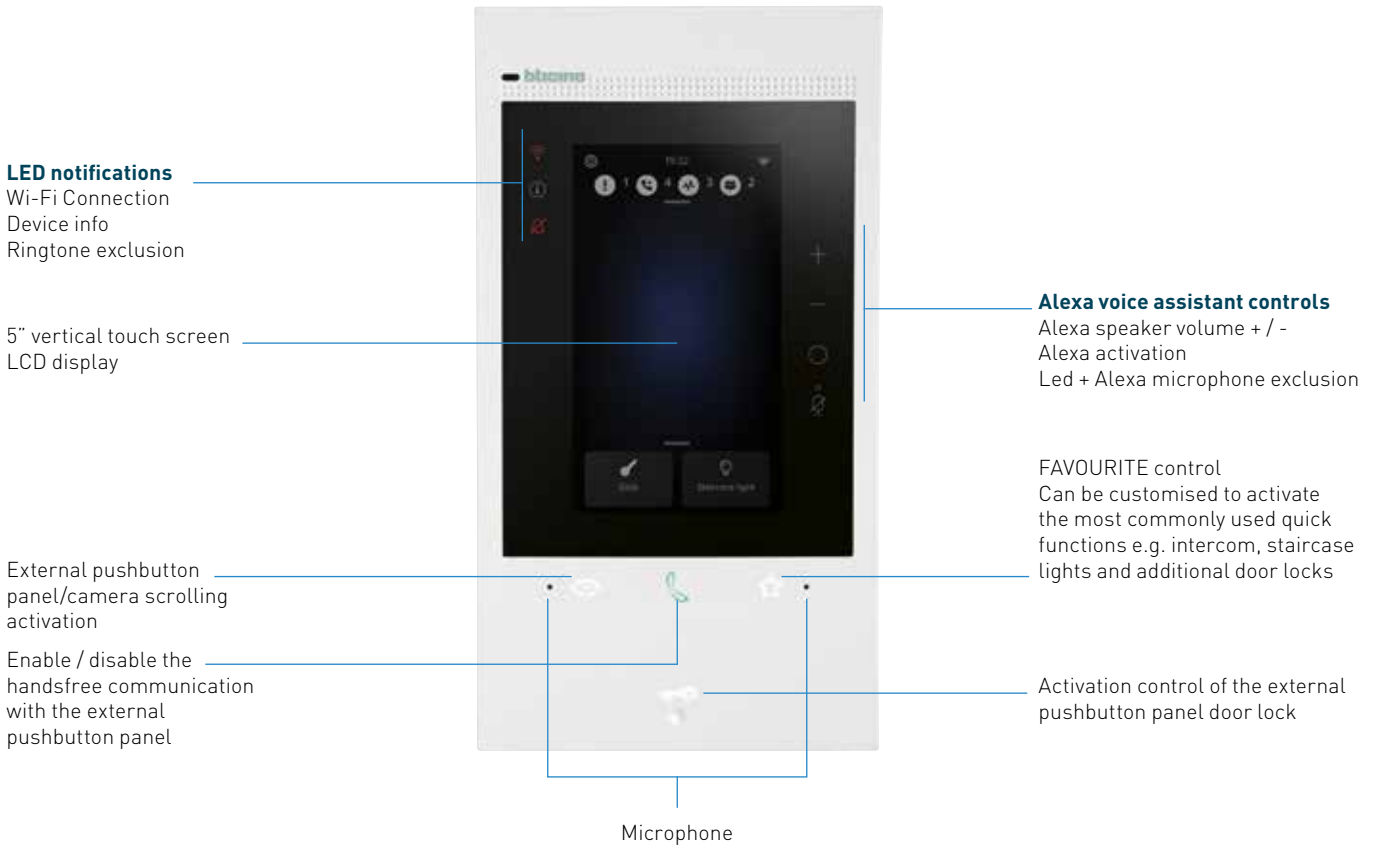

### Back view

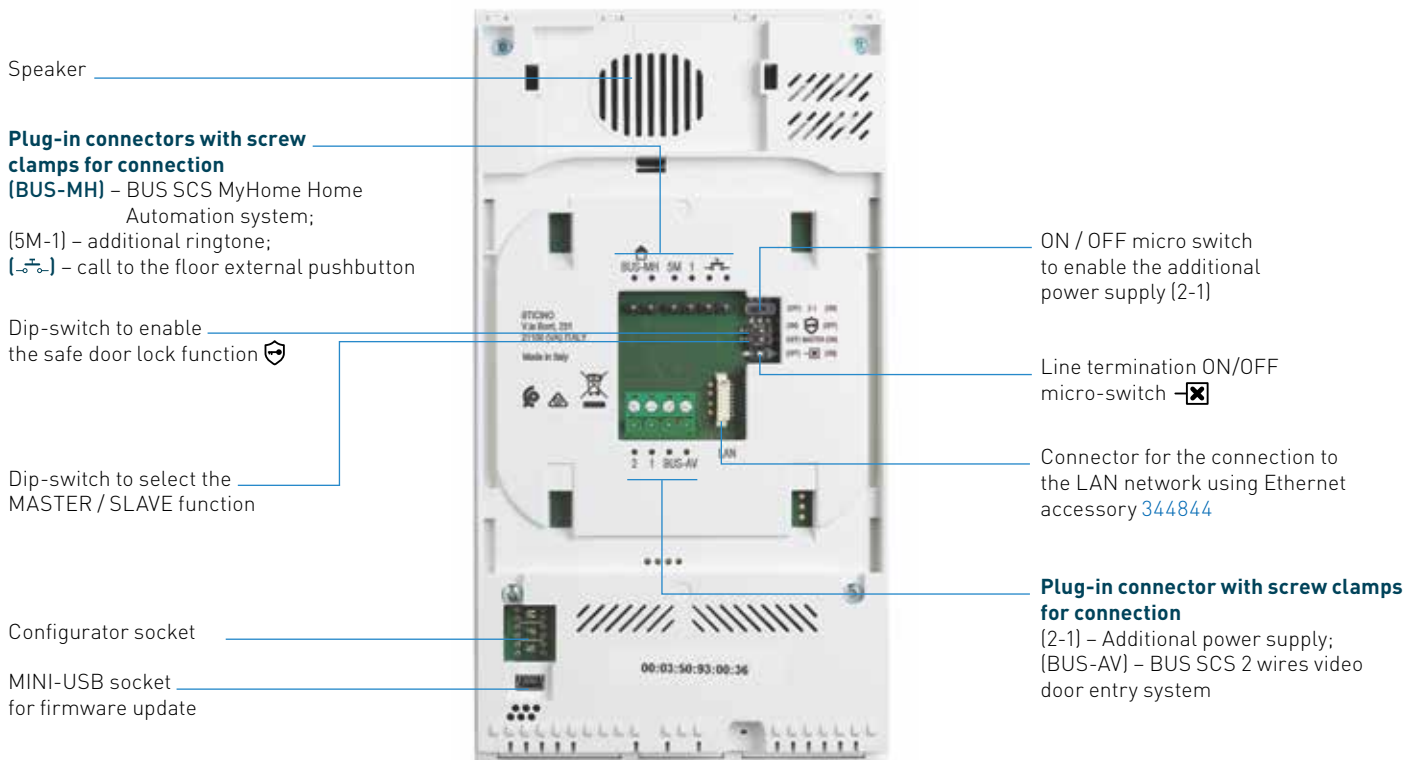



344842



344844



346020

Pack	Item	CLASSE 300EOS WITH NETATMO connected video internal unit
1	344842	<p>2 wires/Wi-Fi handsfree connected video internal unit with built-in Amazon Alexa voice assistant, 5" vertical touch screen LCD display and video door entry answering machine. It has a physical key for door lock release and capacitive keys for the control of the main video door entry functions: handsfree communication, entrance panel activation /camera scrolling and Favourite key (can be configured to activate the quick actions most frequently used – e.g. additional door locks, staircase light control, intercom). There are notification LEDs for: Wi-Fi network connection status, info / notifications and call exclusion.</p> <p>It is possible to easily interact with the built-in Alexa voice assistant, either using the dedicated capacitive keys or with your voice, and activate several functions, such as the video door entry functions, Smart Home, scenarios, reminders etc. Using the touch display, it is possible to access the notification list, as well as your favourite door entry, security and Smart Home controls (if any). Possibility of voice communication with the switchboard - if present in the system - after a specific call. The device must be configured by physically connecting the configurators, or using the menu, which will give better possibilities of customisation of associated functions and texts. Thanks to the Wi-Fi connection, you can associate the video internal unit to the Home + Security App (available for Android and iOS). The App allows to use the main video internal unit functions (receiving calls, door lock release, display of the event timeline and activation of the entrance panel/camera cycling). Through the Home + Security App, it is also possible to manage the products of the Netatmo security range (outdoor and indoor cameras, door and window sensors, indoor siren and smoke detector). This allows you to quickly and easily create a Smart security system. The device also allows to create and manage Smart Home functions, using the wired SCS BUS solution or the Zigbee solution, without the need for adding dedicated gateways. Wall mounted installation using the supplied bracket Possibility of Wi-Fi connection or using RJ45 ethernet cable with the dedicated accessory 344844.</p>

Pack	Item	Ethernet accessory
1	344844	Accessory cable for the wired connection of the Classe 300EOS video internal unit using an RJ45 Ethernet cable. To be purchased separately.
1	346020	<b>2 DIN additional power supply</b> Additional 2 DIN power supply to be used to supply the connected CLASSE 300EOS video internal unit (344842) locally, when required.



# NETATMO PRODUCTS

## Smart Security devices

 Home + Security App



Pack	Item	Smart outdoor camera
1	NOC-PRO	Smart outdoor safety camera with detection of people, animals and vehicles. Aluminium single monobloc construction. Ultra-resistant glass and plastic, protection against UV rays. Video sensor: 4MP. Resolution: Full HD 1080 p. Coding: H.264. Long-range detection: up to 20 m. Field of view: 100°. 8x digital zoom for videos. Video live microphone. LED spotlight: 12 W, variable intensity. Infrared night vision: 15 m. Encryption protected access to the smartphone using the Home + Security App. Weather resistant: designed for outdoor use (HZO protection).
1	NOC-S-PRO	<b>Smart outdoor camera with siren</b> Smart outdoor safety camera with detection of people, animals and vehicles. Equipped with 105 db alarm siren. Aluminium single monobloc construction. Ultra-resistant glass and plastic, protection against UV rays. Video sensor: 4MP. Resolution: Full HD 1080 p. Coding: H.264. Long-range detection: up to 20 m. Field of view: 100°. 8x digital zoom for videos. Video live microphone. LED spotlight: 12 W, variable intensity. Infrared night vision: 15 m. Encryption protected access to the smartphone using the Home + Security App. Weather resistant: designed for outdoor use (HZO protection).

Pack	Item	Smart indoor camera
1	NSC-PRO	Smart indoor safety camera with people detection consisting of an aluminium monobloc unit. Video sensor: 4MP. 130° panoramic view for a wider coverage. High quality video with Full HD 1080 p viewing. Guaranteed day and night protection with infrared vision, for comfortable viewing even in total darkness. Recording only in case of intrusion, in respect of the privacy of the family. Encryption protected access to the smartphone using the Home + Security App. Declaration of conformity and FCC declarations. Open-source compatibility. It has to be connected to an electric socket with the supplied AC adapter.
1	NBU-AS-PRO	<b>Smart video alarm system</b> Smart video security alarm system consisting of 1 smart indoor camera, 1 smart indoor siren and 3 smart door and window opening sensors. The products can be easily configured and associated using the Home + Security app. The smart video alarm system activates and deactivates automatically, has pre-recorded sounds to simulate a presence in the home, respects the privacy of the family and activates a 110 dB sound in case of intrusion.
1	DTG-PRO	<b>Smart door and window sensors</b> Smart opening sensors for doors and windows ideal for safety. Sensors with waterproof monobloc construction, vibration/motion detection and open/closed status. Power supply with 2 AAA-type batteries included in the package. They only work with the smart indoor camera (sold separately): radio link between the sensors and the camera. Declaration of conformity and FCC. Open-source compatibility. Can be controlled and managed remotely with Home + Security app.





NDB - PRO



NSA - PRO - EU



NIS - 01 - PRO



NCO - PRO

Pack	Item	Smart video doorbell
1	NDB-PRO	Smart video doorbell for outdoor installation. Allows you to receive a video call on your smartphone when someone rings the doorbell. Equipped with Camera: 2 megapixels, 5x digital zoom. HDR function of automatic adaptation to lighting conditions. Infrared night vision even in conditions of total absence of brightness. Video: Full HD 1080 p, portrait format 9:16. Field of view: 140° diagonal. Sound: high-quality speaker and microphone. Night vision: Infrared LED. Operating temperature: -10° to 40° C. Weather resistant: H2O protection and IP44 certification. Power supply: 8-24 VAC & 230 VAC; minimum 8 VA. Local storage on microSD memory card and optional storage on Dropbox or FTP server. MicroSD card up to 32 GB (class 10). Data protection with encrypted connection for the highest level of privacy. Requirements: high speed internet access. The minimum required upload and download speed is 25 KB/s. Hotspots are not supported. Wireless specifications: Wi-Fi 802.11 b/g/n (2.4 GHz), Open/WEP/WPA/WPA2-personal. Operation via Home + Security app (iOS 10 required minimum - Android 5.0 required minimum). Compatible with Apple HomeKit, Google Assistant and Amazon Alexa. www

Pack	Item	Smart smoke alarm
1	NSA-PRO-EU	Smart Smoke Alarm with 85 dB alarm, high performance photoelectric sensor, average coverage 50 m². When it detects the presence of smoke, it activates its 85-decibel alarm and immediately alerts you to your smartphone. It is equipped with a 10-year battery - the maximum lifetime for all smoke detectors. The Self-Test feature checks if the Smart Smoke Alarm is functioning correctly. If it detects a problem, it sends a notification to your smartphone. Reliability guaranteed by CE (EN 14604) and NF certifications. Standalone device, no hub required. Compatible with Apple HomeKit. Operation via the Home + Security app. Requirements: High-speed wireless internet connection needed. Public hotspots not supported. The Smart Smoke Alarm will detect smoke and will sound even if the Wi-Fi isn't configured. However, you will need Wi-Fi to receive smartphone alerts. Wi-Fi 802.11 b/g/n (2.4 GHz), Open/WEP/WPA/WPA2-Personal, Bluetooth Low Energy (BLE).

Pack	Item	Smart indoor siren
1	NIS-01-PRO	Smart indoor siren with 110 dB alarm, pre-recorded sounds and vibration sensor for tamper detection. Battery power supply or with a cable (not supplied) using the USB micro port. It only works with the smart indoor camera and must be installed in the same room: Bluetooth Low Energy (BLE) wireless connection with the smart indoor camera. Declaration of conformity and FCC declarations. Open-source compatibility. Operation using the Home + Security app.

Pack	Item	Smart carbon monoxide alarm
1	NCO-PRO	Smart carbon monoxide alarm / detector for wall installation. It allows to monitor the fuel-burning appliances (boiler, fireplace, wood-burning stove, gas cooker, etc.) by measuring, in real time, the levels of carbon monoxide, which is an invisible, odourless and potentially fatal gas. When it detects the presence of carbon monoxide, it activates its 85-decibel alarm and immediately alerts you to your smartphone. It is equipped with a 10-year battery - the maximum lifetime for all carbon monoxide detectors. The Self-Test feature checks if the Smart Carbon Monoxide Alarm is functioning correctly. If it detects a problem, it sends a notification to your smartphone. Reliability guaranteed by CE (EN 50291) and NF certifications. Standalone device, no hub required. Compatible with Apple HomeKit. Operation via the Home + Security app. Requirements: High-speed wireless internet connection needed. Public hotspots not supported. The Smart Carbon Monoxide Alarm will detect Carbon Monoxide and will sound even if the Wi-Fi isn't configured. However, you will need Wi-Fi to receive smartphone alerts. Wi-Fi 802.11 b/g/n (2.4 GHz), Open/WEP/WPA/WPA2-Personal, Bluetooth Low Energy (BLE).

# INTERNAL UNITS

## CLASSE 100

### Features and functions

	Classe 100 X16E	Classe 100 V16E	Classe 100 V16B	Classe 100 V16M	Classe 100 A16E	Classe 100 A16M
						
	344682	344672	344652	344625	344282	344292

#### FEATURES

LCD colour display	5 inches	5 inches	5 inches	4.3 inches		
Handsfree	●	●	●		●	
Finish	white	white	white	white	white	white
Available in KIT	<a href="#">364614</a>	<a href="#">364612</a>	<a href="#">364613</a>		<a href="#">364232</a>	<a href="#">364231</a>
Installation	wall / table	wall / table	wall / table	wall	wall / table	wall / table

#### AVAILABLE FUNCTIONS FROM AUDIO / VIDEO INDOOR UNIT

Door lock activation	●	●	●	●	●	●
Staircase light activation	●	●	●	●	●	●
EP / Scrolling activation	●	●	●	●	●	●
Intercom (1)	●	●	●	●	●	●
Inductive loop (2)	●	●				
Floor call	●	●	●	●	●	●
No. of configurable keys	4	4	1	1	4	4
No. of available ringtones	20	16	16	16	16	16
Professional Studio (Office)	●	●			●	●
Wi-Fi connectivity	●					

#### AVAILABLE FUNCTIONS FROM DOOR ENTRY APP

Answer video door entry system calls	●					
Door lock activation	●					
Staircase light activation	●					
Intercom call from smartphone to video indoor unit	●					
Netatmo Smart cameras interoperability	●					
EP / Scrolling activation	●					

1) Audio call, max. 3 minutes, between indoor units of the same apartment/different apartments  
 2) Use by people wearing hearing aids fitted with T selector

## Front view

### Touch sensitive controls



Door lock activation



Entrance panel/camera scrolling activation



Staircase light activation



Customisable controls for the activation of accessory functions (e.g. intercom, activation of additional door lock, various activations)

### Physical control

Enable the handsfree communication



### LED notifications



Wi-Fi Connection



Ringtone exclusion

Tactile guide

### Physical control

Disable the handsfree communication

## Rear view

Plug-in connectors with screw clamps for connections

Adjustment and programming menu access and navigation joystick

Line termination ON/OFF micro-switch

ON / OFF micro switch to enable the additional power supply

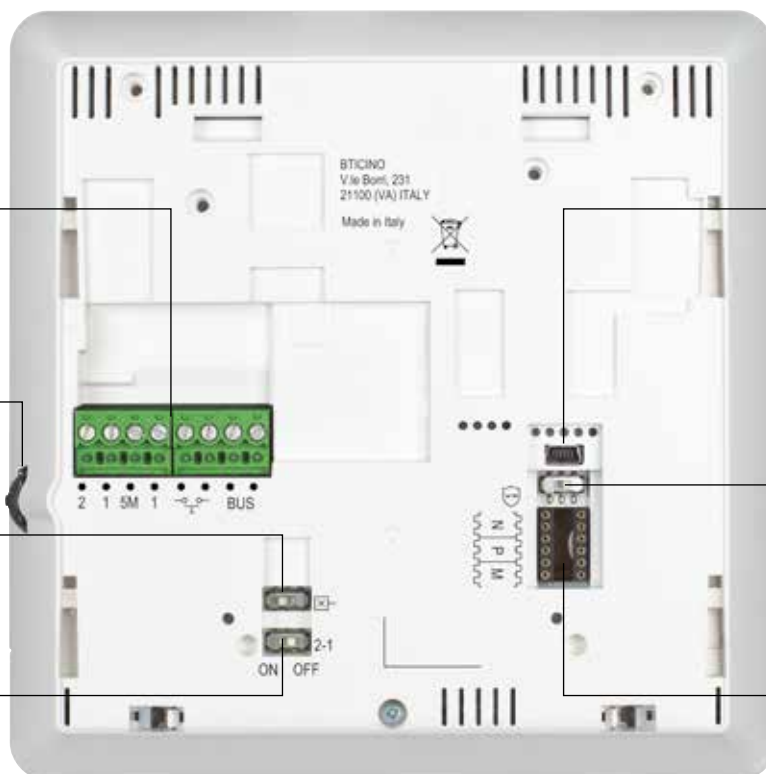

USB mini socket for firmware update

ON / OFF micro switch to enable the Safe Door Lock function

Configurator socket

# INTERNAL UNITS

## CLASSE 100



344682



344672



344652



344625



Door Entry  
CLASSE 100X App  
See note (\*)

Pack	Item	CLASSE 100X16E connected video indoor unit
1	344682	<p>2 WIRES/Wi-Fi handsfree connected video indoor unit with inductive loop and 5" colour LCD display. It has 2 physical keys for the control of the main video door entry functions – answer and end a call – it has 3 touch keys for the control of the main functions – door lock release, staircase light control and entrance panel activation/scrolling – there are further 4 configurable touch keys that perform different functions – e.g. intercom, additional door lock activation, generic activations. The device has a side lever to adjust: colour, brightness and display contrast, audio volume, call tone volume and Wi-Fi configuration. There are call exclusion notification LEDs and Wi-Fi. Also, thanks to the Wi-Fi connection, you can associate the video indoor unit to the Door Entry App (available for Android and iOS). You can manage the main video indoor unit functions (receiving calls, opening the door lock, activating the entrance panel/scrolling, firmware updating and additional activations) from the App. Netatmo Smart Outdoor &amp; Smart Indoor cameras interoperability. The installation can be made to the wall using the bracket (supplied) or using table support accessories (2 x 344692) – to be purchased separately. The device also has Professional Studio (Office) function and must be configured.</p>
1	344672	<p>2 WIRES handsfree video indoor unit, with inductive loop and 5" colour LCD display. It has 2 physical keys for the control of the main video door entry functions – answer and end a call – it has 3 touch keys for the control of the main functions – door lock release, staircase light control and entrance panel activation/scrolling – there are further 4 configurable touch keys that perform different functions – e.g. intercom, additional door lock activation, generic activations. The video indoor unit has a side lever to adjust: colour, brightness and display contrast, audio and call tone volume. There is a call exclusion notification LED. The installation can be made to the wall using the bracket (supplied) or using table support accessories (2 x 344692) – to be purchased separately. The device also has Professional Studio (Office) function and must be configured.</p>

Pack	Item	CLASSE 100V16B video indoor unit
1	344652	<p>2 WIRES handsfree video indoor unit with 5" colour LCD display. The device has 2 physical keys for the control of the main video door entry functions – answer and end a call – and 3 touch keys that allow the door lock release, the entrance panel activation/scrolling and the customisation of a most frequently used quick action – e.g. staircase light control, intercom, additional door lock activation, generic activations. The device has a side lever to adjust: colour, brightness and display contrast, audio and call tone volume. There is a call exclusion notification LED. The installation can be made to the wall using the bracket (supplied) or using table support accessories (2 x 344692) – to be purchased separately. The device must be configured.</p>
1	344625	<p>CLASSE 100V16M video indoor unit</p> <p>2 WIRES video indoor unit with handset and 4.3" colour LCD display, suitable for wall mounting installation (bracket support included). The device has three touch keys that allows : door lock release, entrance panel camera activation/scrolling and customization of an auxiliary function – e.g. additional door lock activation, additional camera activation. Side easily accessible and independent regulations for : call volume / ringtone exclusion (with notification LED), display colour and brightness. The handset has magnets for easy holding.</p>

**NOTE (\*):**  
**in the course of 2022, the Door Entry Classe 100X App will migrate to the new Home + Security App.**



344282



344292



344692



336803



336982



346020

Pack	Item	CLASSE 100A16E HANDSFREE audio indoor unit
1	344282	2 WIRES handsfree audio indoor unit for wall mounted or table installation. It has 2 physical keys for the control of the main functions – answer and end a call – and has 3 touch keys for the control of the main functions – door lock release, staircase light control and entrance panel activation/scrolling – there are further 4 configurable touch keys that perform different functions – e.g. intercom, additional door lock activation, generic activations. The device has a side lever to adjust the audio volume and call tone and a call exclusion notification LED. The installation can be made to the wall using the bracket (supplied) or using table support accessory (1 x 344692) – to be purchased separately. The device also has Professional Studio (Office) function and must be configured.

Pack	Item	CLASSE 100A16M audio indoor unit with handset
1	344292	2 WIRES audio indoor unit with handset for wall mounted or table installation. It has 3 touch keys for the control of the main functions – door lock release, staircase light control and entrance panel activation/scrolling – there are further 4 configurable touch keys that perform different functions – e.g. intercom, additional door lock activation, generic activations. Ringtone volume adjustment (with call exclusion) using the appropriate selector. The installation can be made to the wall using the bracket (supplied) or using table support accessory (1 x 344692) – to be purchased separately. The device also has Professional Studio (Office) function and must be configured.

Pack	Item	Accessories - table support - cable - sockets
1	344692	Table support accessory for CLASSE 100 audio and video indoor units.
1	336803	8-way cable with connector for tabletop support connection.
1	336982	White Livinglight series 8-pole plug for the connection of the 336803 cable in tabletop installations.  The socket is available also in the following finishings: - LIVINGLIGHT (336983 - 336984); - AXOLUTE (349414 - 349415 - 349418); - MATIX (336985).
1	346020	<b>2 DIN additional power supply</b> Additional 2 DIN power supply to be used for the local power supply to connected CLASSE 100x16E (344682) video indoor units in multi-family systems in complexes with more than 22 apartments.

# INTERNAL UNITS

## SPRINT L2



344242



344232

Pack	Item	SPRINT L2 audio handsets
1	344242	2 WIRE audio handset (without the possibility of fitting with accessories) for audio systems and mixed audio /video systems. Wall mounted installation without the need of accessories. With door lock release key and auxiliary functions key (that can be configured). Ringtone volume adjustable on 3 levels. White
1	344232	As item 344242 but with call to the floor function



**1** Simple and modern design



**2** Ringtone volume, adjustable to 3 levels



**3** Two pushbuttons:  
- door lock release  
- available for applications (e.g. control of staircase lights)

### DIMENSIONAL DATA

344232

Size in mm

## Guard Station and Software switchboard



346310



346300

Pack	Item	Guard station and accessories
1	346310	Guard station for 2 WIRE audio and video systems. Allows access to various services (video door entry functions, door lock/ staircase light management and apartment alarm monitoring) directly from the keypad or via the intuitive icon menu. The guard station is supplied with an integrated table supporting frame and also features a 7" colour LCD display, receiver and speaker phone, dedicated keys for the main functions and keys which can be configured. The programming can be carried out directly from the device or via PC with TiSwitchBoardDevice software (supplied). The device can manage the phonics of the riser EP (i.e. wired downstream of interface 346851); it cannot however manage the apartment EP (i.e. wired downstream of interface 346850). The use of an additional power supply is recommended. It is possible to connect up to a max. of 16 switchboards (configured from 0 to 15). <b>WARNING: the guard station cannot be used in systems with 2 WIRE-IP interface 346890. The new HIERARCHICAL mode is available only with the entrance panels of the following series: Sfera New, Linea 100, Linea 300.</b>
1	336982	White 8-way socket for table top installation of guard station item 346310
1	336803	8 - Way cable with connector for the table top installation connection.

Pack	Item	SOFTSWITCHBOARD software
1	346300	Switchboard software for the management of audio and video door entry system calls. The software (Windows operating system compatible) can be installed on any desktop or laptop PC, and gives the possibility of receiving, managing and transferring the calls from the entrance panel and the handset. It implements home video monitoring, with cyclical display of the cameras, night and day functions, and the possibility of displaying the alarms in the various apartments. - Supported operating systems: Microsoft Windows XP Service Pack 2, Windows Vista and Windows 7. - Software required: NET Framework 3.5 or higher

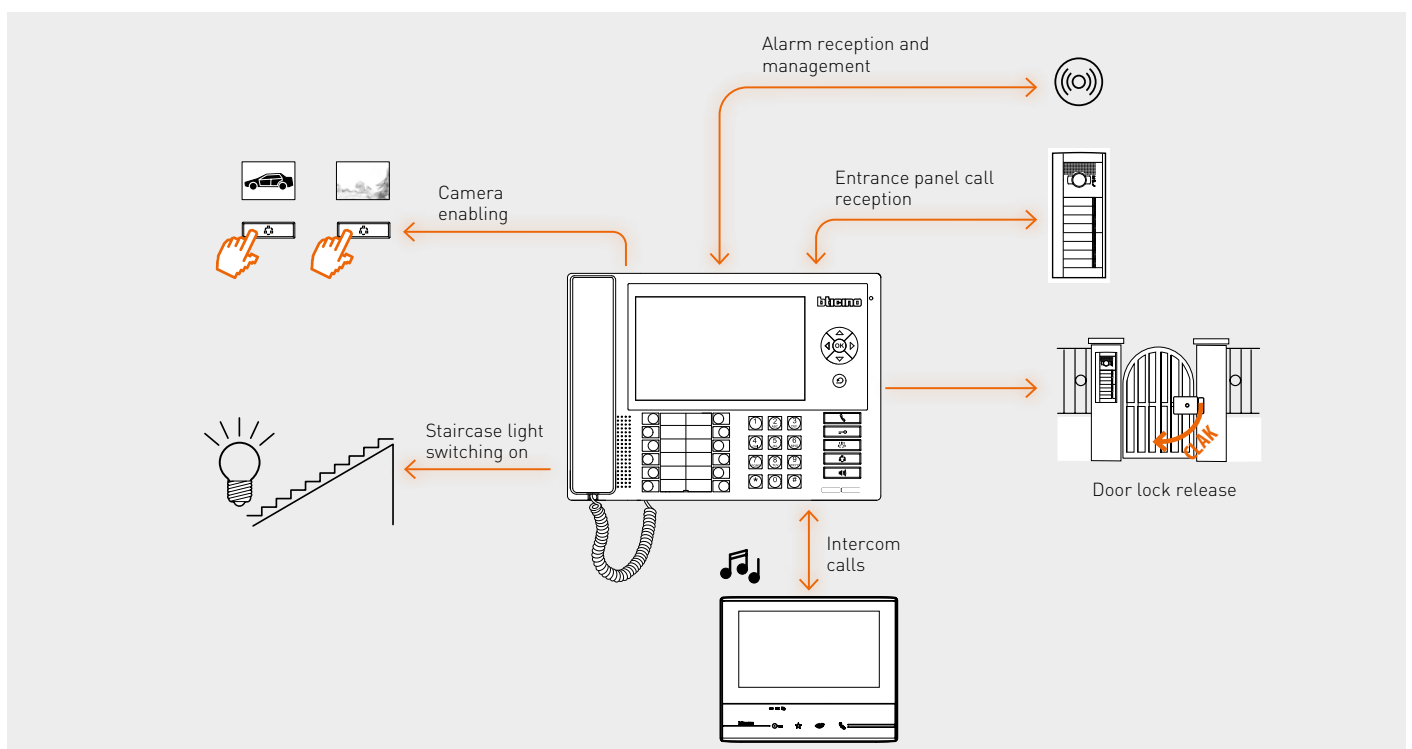

# SYSTEM ACCESSORIES

## Accessories



346050 SELV



346030 SELV



F441



346850



346851



346040 SELV



346020 SELV

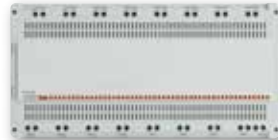

F441M

Pack	Item	Power supplies
1	346050	Power supply for 2 WIRES system in 6 DIN modular enclosure. Power supply 110 – 240 Vac @ 50 – 60 Hz. The output provides two power supplies in very low safety voltage (one on the 3 TK BUS, IU BUS and SCS clamps, one on the 1 - 2 clamp) to be used alternately and NOT at the same time. To be used in audio, video or mixed audio video systems. The video adapter is integrated in the device (item 346830 must not be used). It is therefore possible to avoid the use of the A/V node (F441) or the Multi-channel Matrix (F441M), if three junctions (MAX 2 IU + 1 TK risers or 1 IU + MAX 2 TK risers) are not exceeded in total from the clamps. It can also be used as additional power supply (1 - 2 output) for the local power supply of the preset internal units or entrance panels (in this case it is not possible to use other outputs). The device is electronically protected against overload and short circuit. It is a SELV double insulation safety device. The installation must be made in compliance with current regulations. The device must not be configured. <b>WARNING: the (IU BUS), (TK BUS) and (SCS) outputs can be used at the same time respecting the total maximum absorption of 1.2 A.</b> <b>WARNING: Disconnect the power supply for 5 minutes after overload or short circuit.</b>
1	346040	Power supply for 2 WIRES audio systems in 6 DIN modular enclosure. Power supply 110 – 240 Vac @ 50-60 Hz. The output provides 26 Vdc low rated voltage, and a maximum rated current of 600 mA and it is protected on the PRI side (with fuse) against overload and short circuit. It is a SELV double insulation safety device.
1	346030	Mini power supply with integrated video adapter to make small 2-WIRES video systems (intercom). 2 DIN modular enclosure. Power supply 230 Vac @ 50-60 Hz. The output provides 27 Vdc continuous low voltage, with maximum current of 600 mA and it is protected on the PRI side (with fuse) against overload and short circuit. It is a SELV double insulation safety device.
1	346020	Additional power supply to be used to supply the set up entrance panels and internal units locally. 2 DIN modular enclosure. Power supply 230 Vac @ 50-60 Hz. The output provides 27 Vdc continuous low voltage, with maximum current of 600 mA and it is protected on the PRI side (with fuse) against overload and short circuit. It is a SELV double insulation safety device.

Pack	Item	Video mixers
1	F441	Audio video node in 6-DIN modular enclosure set up with 4 input terminals and 4 output terminals. Can connect up to 4 source devices (entrance panels or cameras) in input and up to 4 2-WIRES video risers in output. The device must be used with the system power supply 346000. It must be used as an alternative to the audio video adapter 346830
1	F441M	Multi-channel matrix in 10 DIN modular enclosure. Set up for the connection of video entry system entrance panels, cameras and sound system sources in input and internal units and amplifiers in output. 4 inputs are dedicated to entrance panels/cameras and 4 to the sound system sources. It can be used to create multi-channel sound systems. The device must be used with the system power supply 346000. In the systems it replaces the video adapter 346830 and the audio video node F441
<b>System interfaces</b>		
1	346850	Apartment interface in 4 DIN modular enclosure. Can interface a dedicated apartment video door system with local CCTV, sound system and control of the Home automation applications to a 2-WIRES riser. The device must be configured using physical configurators
1	346851	System expansion interface in 4 DIN modular enclosure. Can double the length of the entrance panel-internal unit line, create risers with independent sound and expand the performance of the apartment system. The device must be configured using physical configurators





346891



346260



346210



346841



347400



346870



346993



346250



3499



354000

Pack	Item	Interfaces with other BTicino systems
1	<a href="#">346891</a>	Can make very large mixed 2 WIRES/IP systems with a large number of devices, thanks to the creation of an IP backbone with 2-WIRES risers. The device must be configured using physical configurators or using the software
1	<a href="#">346150</a>	8/2-WIRES interface in 6 DIN modular enclosure. Can make mixed video door entry systems (8-WIRES digital backbone/2-WIRES risers). The device must be configured using physical configurators
1	<a href="#">349410</a>	Analogue/2 WIRES interface in 4 DIN modular enclosure. Can interface a dedicated apartment 2-WIRE video door entry system with cameras and control of the MyHOME applications to an analogue riser, digital 8-WIRES, audio TERSYSTEM and VIDEOPORTER 2000.

Pack	Item	DIN actuators
1	<a href="#">346210</a>	Relay actuator in 2 DIN modular enclosure. Can switch on lights, open gates, repeat the call on bells (MOD=SLA) or control other devices from the video internal units. The device must be configured using physical configurators
1	<a href="#">346230</a>	Door lock relay actuator in 2 DIN modular enclosure. Can supply power and activate an electrical door lock. The device must be configured using physical configurators
1	<a href="#">346260</a>	Timed door lock relay actuator in 4 DIN modular enclosure. Can switch on lights, open gates or manage electro-magnetic door locks, timed door opening and door lock status (with NC contact). The device must be configured using physical configurators

Pack	Item	Devices in basic enclosure
1	<a href="#">346841</a>	Floor shunt with 4 outputs Can make 2-WIRES video door entry systems with star wiring distribution. The device automatically adapts the video signal. Its small size means it can also be placed inside the flush-mounted box
1	<a href="#">346833</a>	Call to the floor interface. By connecting a traditional pushbutton, the following functions will be possible: general call to the floor, addressed call to the floor, staircase lights on, and door lock release (specific actuator needed) and association of the video image to the call to the floor. The device must be configured using physical configurators
1	<a href="#">347400</a>	Interface for the conversion of the coaxial signal into a 2 WIRES BUS signal. It can be used to connect to the BUS of the 2 WIRES video door entry system a camera with coaxial video output powered at 12 Vdc, with maximum absorption 150 mA and 1 Vpp video output (75 Ω). The device must be configured using physical configurators

Pack	Item	Wiring accessories
1	<a href="#">346870</a>	2 WIRES video amplifier. In video systems wired using non-twisted wires, where the distance between the entrance panels and the internal unit exceeds 50 metres, it enables increasing such distance to up to 100 metres
1	<a href="#">346250</a>	Relay module for gate opening to be used with LINEA 2000, LINEA 3000, MINISFERA and SFERA pushbutton panels. Can open door locks (NOT managed by BUS) by means of the entrance panel
5	<a href="#">3499</a>	Line terminator. To be used to terminate the riser or apartment line, when the last installed device is not fitted with line closing micro switch
1	<a href="#">354000</a>	Flat cable for the connection of several SFERA NEW and SFERA ROBUR pushbutton modules. Length 470 mm

# SYSTEM ACCESSORIES

## Accessories



346991



336904  
336905



3515



3501/1



3501K

Pack	Item	Universal speaker unit and expansion module
1	<a href="#">346991</a>	The universal speaker unit can be used to install the 2 WIRES audio system in new or refurbished systems, where pushbutton panels of other manufacturers are present or required (mail boxes, patterned brass, compact sheet metal units, etc.), preset for a traditional speaker module (e.g. 2659N). The universal speaker unit has, as base, contacts for the connection of 8 call keys; to make systems with more keys (up to 56 using the 346000 power supply and up to 24 with the 346010 power supply one or more key expansion modules must be used [1 every 8 pushbuttons]).
1	<a href="#">346992</a>	Expansion module for connecting more than 8 call keys to item <a href="#">346991</a> - max. 6 modules (56 calls max.) with power supply 346000. Max. 2 modules (24 calls max.) with power supply 346010
<b>Cable for systems</b>		
1	<a href="#">336904</a>	Specific cable for 2 WIRES video door entry applications with 2 twisted conductors. It can be installed in underground piping, in accordance with standards (CEI 20-13 and CEI 20-14). It ensures the best performance in video systems (higher distance between EP and Handset when compared with other cables). 200 m coil
1	<a href="#">336905</a>	Specific cable for BUS / SCS unshielded, consisting of a white outer sheath and 2 flexible conductors twisted together with a cross section of 0.50 mm <sup>2</sup> . Halogen-free low-toxicity cable; <b>ideal for applications in environments where greater regard is required for safety in the event of fire (halogen free)</b> . 400 V insulation. Compliant with standards: EN 50575 EN60811, EN50289, EN50290, EN60228, 50265-2-1, EN50395, EN50396. Cable not suitable for burial. Coil length 200 m. Fire reaction class according to CPR regulation: Ccas1b, d1, a1.
<b>Spare part terminal/clamp</b>		
1	<a href="#">3515</a>	Spare part terminal/clamp for BUS connection of the predisposed devices

Pack	Item	Configurators (package of 10 pieces)
10	<a href="#">3501/0</a>	Configurator 0
10	<a href="#">3501/1</a>	Configurator 1
10	<a href="#">3501/2</a>	Configurator 2
10	<a href="#">3501/3</a>	Configurator 3
10	<a href="#">3501/4</a>	Configurator 4
10	<a href="#">3501/5</a>	Configurator 5
10	<a href="#">3501/6</a>	Configurator 6
10	<a href="#">3501/7</a>	Configurator 7
10	<a href="#">3501/8</a>	Configurator 8
10	<a href="#">3501/9</a>	Configurator 9
10	<a href="#">3501/JMP</a>	Configurator JMP

Pack	Item	Configurator kit
1	<a href="#">3501K</a>	Configurator kit consisting of: - 10 pieces for each type of configurator from 0 to 9 - 2 blue removable 8-clamp connectors - 2 green removable 2-clamp connectors - 1 configurator connection tool (3502) - 1 plastic screwdriver

# PROFESSIONAL KITS

## Villa Connected Video Kits



363950

**Note:** Packaging graphics are subject to changes / updates.

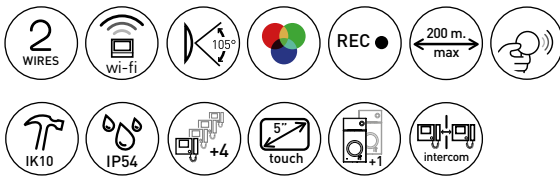

Pack	Item	CLASSE 300EOS - LINEA 3000 - NETATMO SMART OUTDOOR CAMERA CONNECTED KIT
1	363950	<p>One-family kit with Classe 300EOS handsfree connected video internal unit, LINEA 3000 pushbutton panel in black finish and Netatmo Smart Outdoor Camera.</p> <p>2 wires/Wi-Fi handsfree connected video internal unit with Teleloop, built-in Amazon Alexa voice assistant, 5" vertical touch screen LCD display and video door entry answering machine. Easy interaction with the built-in Alexa voice assistant, either using the dedicated capacitive keys or with your voice, and activate several functions, such as the video door entry functions, Smart Home, scenarios, reminders etc. Thanks to the Wi-Fi connectivity, you can associate the video internal unit to the Home + Security App (available for Android and iOS).</p> <p>The App allows to use the main video internal unit functions (receiving calls, door lock release, display of the event timeline and activation of the entrance panel/camera cycling). With the Home + Security App, it is also possible to manage the products of Netatmo security range (outdoor and indoor cameras, door and window sensors, indoor siren, smoke detector). This allows you to quickly and easily create a Smart security system. The device also allows to create and manage Smart Home functions, using the wired SCS BUS solution or the Zigbee solution, without the need for adding dedicated gateways.</p> <p>LINEA 3000 pushbutton panel with black finish zamak front cover, wide angle colour camera and proximity reader and with a kit of coloured key cards and two clear discs for door lock release. Can be wall or flush installed with specific accessories: (350020) flush mounted box and (343063) flush mounted accessory - to be purchased separately. Can be fitted with rainshield (343053) - to be purchased separately. The pushbutton panel has a protection index IP54- protection index against mechanical impact IK10.</p> <p>Smart Outdoor Security Camera with LED lighting spotlight, night vision and motion detection - send real time notification on smartphone in case of unknown person or vehicle detection.</p>
		<p><b>Complete one family kit</b>                      (Easy switch to two families system by purchasing an additional internal unit - refer to 2 Wires system internal units range).</p>



**HOME + SECURITY** is the App that allows, through the smartphone, to manage calls locally and remotely of the video door phone or with a simple touch to open the gate, the activation of the cameras, and switching on of the timed lights in the garden. Allows you to activate and view images of Netatmo Smart Outdoor and Indoor Cameras. Setting up the App requires a few steps and thanks to the BTicino Cloud, the remote connection is fully automated and managed with the highest level of security.

Item	KIT COMPOSITION	Qty
343093	LINEA 3000 pushbutton panel	1
344842	CLASSE 300EOS video internal unit	1
NOC-PRO	Smart Outdoor Camera	1
346050	6 DIN SCS power supply	1
346250	Door lock relay accessory	1
348260	Set of coloured door lock release key cards	1
348261	Set of door lock release clear discs	1

# PROFESSIONAL KITS

## Villa Connected Video Kits



363915

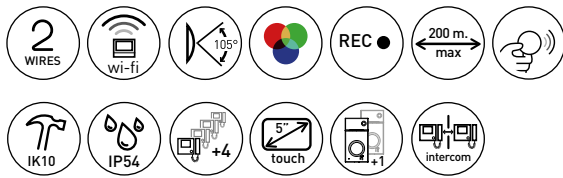
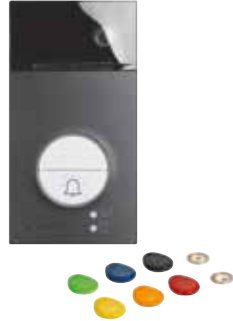

Pack Item **CLASSE 300EOS WITH NETATMO – LINEA 3000 CONNECTED VIDEO KIT**

One-family kit with Classe 300EOS handsfree connected video internal unit and LINEA 3000 pushbutton panel in black finish.  
 2 wires/Wi-Fi handsfree connected video internal unit with built-in Amazon Alexa voice assistant, 5" vertical touch screen LCD display and video door entry answering machine. Easy interaction with the built-in Alexa voice assistant, either using the dedicated capacitive keys or with your voice, and activate several functions, such as the video door entry functions, Smart Home, scenarios, reminders etc. Thanks to the Wi-Fi connectivity, you can associate the video internal unit to the Home + Security App (available for Android and iOS). The App allows to use the main video internal unit functions (receiving calls, door lock release, display of the event timeline and activation of the entrance panel/camera cycling). With the Home + Security App, it is also possible to manage the products of Netatmo security range (outdoor and indoor cameras, door and window sensors, indoor siren, smoke detector). This allows you to quickly and easily create a Smart security system. The device also allows to create and manage Smart Home functions, using the wired SCS BUS solution or the Zigbee solution, without the need for adding dedicated gateways.  
 LINEA 3000 pushbutton panel with black finish zamak front cover, wide angle colour camera and proximity reader and with a kit of coloured key cards and two clear discs for door lock release. Can be wall or flush installed with specific accessories: (350020) flush mounted box and (343063) flush mounted accessory - to be purchased separately. Can be fitted with rainshield (343053) - to be purchased separately. The pushbutton panel has a protection index IP54- protection index against mechanical impact IK10.

1

**363915**

**Complete one family kit**  
 (Easy switch to two families system by purchasing an additional internal unit - refer to 2 Wires system internal units range).

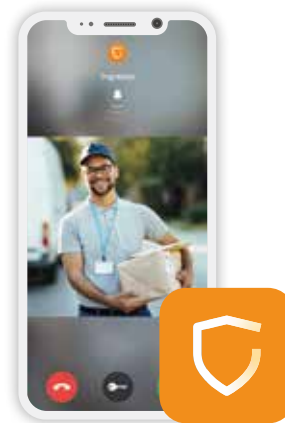

**HOME + SECURITY** is the App that allows, through the smartphone, to manage calls locally and remotely of the video door phone or with a simple touch to open the gate, the activation of the cameras, and switching on of the timed lights in the garden. Allows you to activate and view images of Netatmo Smart Outdoor and Indoor Cameras. Setting up the App requires a few steps and thanks to the BTicino Cloud, the remote connection is fully automated and managed with the highest level of security.

Item	KIT COMPOSITION	Qty
343093	LINEA 3000 pushbutton panel	1
344842	CLASSE 300EOS video internal unit	1
346050	6 DIN SCS power supply	1
346250	Door lock relay accessory	1
348260	Set of coloured door lock release key cards	1
348261	Set of door lock release clear discs	1



364614



**Pack**      **Item**      **CLASSE 100X16E - LINEA 3000 CONNECTED VIDEO KIT**

One-family handsfree kit with: CLASSE 100X16E Wi-Fi connected video indoor unit, handsfree function, inductive loop, 5» LCD display; LINEA 3000 pushbutton panel with zamak front cover, wide angle colour camera, proximity reader and with a set of coloured key cards and two clear discs for door lock release. Can be configured for one-family and two-family installations. It can manage a maximum of 20 key cards (125 KHz) for the electric door lock release (including the one for the system management). Nameplate lit by white LED. Can be wall or flush installed with specific accessories: (350020) flush mounted box and (343061) flush mounted accessory - to be purchased separately. Can be fitted with rainshield (343051)- to be purchased separately. The pushbutton panel has a protection index IP54- protection index against mechanical impact IK10. The video indoor unit has inductive loop function (to enable use by people wearing hearing aids fitted with T selector). It has 2 physical keys for the control of the main functions – answer and end a call – and has 3 touch keys for the control of the main functions – door lock release, staircase light control and entrance panel activation/scrolling – there are further 4 configurable touch keys that perform different functions – e.g. intercom, additional door lock activation, generic activations. It has a side lever to adjust: colour, brightness and display contrast, audio volume, call tone volume and Wi-Fi configuration. There are call exclusion notification LEDs and Wi-Fi. Also, thanks to the Wi-Fi connection, you can associate the video indoor unit to the Door Entry App (available for Android and iOS). You can manage the main video indoor unit functions (receiving calls, opening the door lock, activating the entrance panel/scrolling, firmware updating and additional activations) from the App. The installation can be made to the wall using the bracket supplied or using table support accessories (2 x 344692) – to be purchased separately. The device also has Professional Studio (Office) function and must be configured.

1      364614      **Complete one family kit**  
 (Easy switch to two families system by purchasing an additional internal unit - refer to 2 Wires system internal units range).



**DOOR ENTRY CLASSE 100X** is the App which lets you, using your smartphone, manage the video internal unit calls locally and remotely or with a simple touch open the gate, activate the cameras and switch the garden timed lights on. Configuring the App needs just a few steps and, thanks to the BTicino Cloud, the remote connection is totally automated and managed with the maximum level of security.

**ATTENTION:**  
**the DOOR ENTRY CLASSE 100X app will migrate to the new HOME + SECURITY app in the year 2022.**

Item	KIT COMPOSITION	Qty
343091	LINEA 3000 Entrance panel	1
344682	CLASSE 100X16E Video internal unit	1
346050	6 DIN System power supply	1
346250	Relay module accessory	1
348260	Set of door lock release badges	1
348261	Set of door lock release clear discs	1

# PROFESSIONAL KITS

## Villa Video Kits



364612

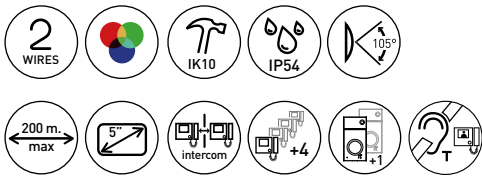

Pack	Item	CLASSE 100V16E - LINEA 3000 VIDEO KIT
1	364612	<p>One-family handsfree kit with CLASSE 100V16E video indoor unit and LINEA 3000 pushbutton panel with zamak front cover and wide angle colour camera. Can be configured for one-family or two-family installations. Nameplate lit by white LED. Can be wall or flush installed with specific accessories: (350020) flush mounted box with (343061) flush mounted accessory - to be purchased separately. Can be fitted with rainshield (343051) - to be purchased separately.</p> <p>The pushbutton panel has a protection index IP54 - protection index against mechanical impact IK10. The video indoor unit has 5" LCD display and Inductive Loop function (to enable use by people wearing hearing aids fitted with T selector). It has 2 physical keys for the control of the main functions - answer and end a call - and has 3 touch keys for the control of the main functions - door lock release, staircase light control and entrance panel activation/scrolling - there are further 4 configurable touch keys that perform different functions - e.g. intercom, additional door lock activation, generic activations.</p> <p>Wall mounted installation with the bracket supplied or table installation with support accessories (2 x 344692) - to be purchased separately.</p> <p>The device also has Professional Studio (Office) function and must be configured.</p> <p><b>Complete one family kit</b>                      (Easy switch to two families system by purchasing an additional internal unit - refer to 2 Wires system internal units range).</p>

Item	KIT COMPOSITION	Qty
343081	LINEA 3000 Entrance panel	1
344672	CLASSE 100V16E Video internal unit	1
346050	6 DIN System power supply	1
346250	Relay module accessory	1



364613



364622

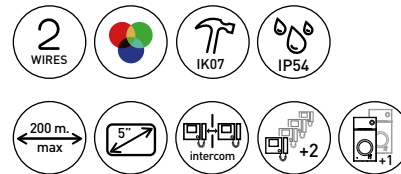

Pack	Item	CLASSE 100V16E - LINEA 2000 VIDEO KIT
1	<b>364613</b>	<p>One-family handsfree video kit consisting of: CLASSE 100V16B video indoor unit, LINEA 2000 pushbutton panel with colour camera and 1 call pushbutton.</p> <p>The push-button panel has a protection index against mechanical impact IK07 and protection index IP54.</p> <p>The video indoor unit has 2 physical keys for the control of the main video door entry functions – answer and end a call – and 3 touch keys that allow the door lock release, the entrance panel activation/scrolling and the customization of a most frequently used quick action – e.g. staircase light control, intercom, additional door lock activation, generic activations. The video indoor unit has a 5" colour LCD display and a side lever to adjust: colour, brightness and display contrast, audio and call tone volume. There is a call exclusion notification LED. Wall mounted installation with the bracket supplied or table installation with support accessories (2 x <a href="#">344692</a>) - to be purchased separately.</p>

Pack	Item	CLASSE 100V16B - LINEA 2000 VIDEO KIT
1	<b>364622</b>	<p>Two-families handsfree video kit consisting of: CLASSE 100V16B video indoor units, LINEA 2000 pushbutton panel with colour camera and 2 call pushbuttons. The push-button panel has a protection index against mechanical impact IK07 and protection index IP54.</p> <p>The video indoor units has 2 physical keys for the control of the main video door entry functions – answer and end a call – and 3 touch keys that allow the door lock release, the entrance panel activation/scrolling and the customization of a most frequently used quick action – e.g. staircase light control, intercom, additional door lock activation, generic activations. The video indoor units has a 5" colour LCD display and a side lever to adjust: colour, brightness and display contrast, audio and call tone volume. There is a call exclusion notification LED. Wall mounted installation with the bracket supplied or table installation with support accessories (2 x <a href="#">344692</a>) - to be purchased separately.</p>

Item	KIT COMPOSITION	Qty
<a href="#">343031</a>	LINEA 2000 Entrance panel - 1 CALL	1
<a href="#">344652</a>	CLASSE 100V16B Video internal unit	1
<a href="#">346050</a>	6 DIN System power supply	1
<a href="#">346250</a>	Relay module accessory	1

Item	KIT COMPOSITION	Qty
<a href="#">343032</a>	LINEA 2000 Entrance panel - 2 CALLS	1
<a href="#">344652</a>	CLASSE 100V16B Video internal unit	2
<a href="#">346050</a>	6 DIN System power supply	1
<a href="#">346250</a>	Relay module accessory	1

# PROFESSIONAL KITS

## Villa Audio Kits



364232



364231

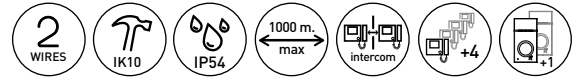
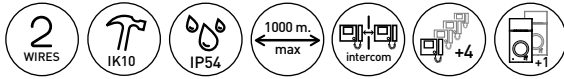

Pack	Item	CLASSE 100A16E - LINEA 3000 HANDS FREE AUDIO KIT
1	<a href="#">364232</a>	One-family handsfree kit with CLASSE 100A16E audio indoor unit and LINEA 3000 pushbutton panel with zamak front cover. Can be configured for one-family or two-family installations. Nameplate lit by white LED. Can be wall or flush installed with specific accessories: <a href="#">[350020]</a> flush mounted box with <a href="#">[343061]</a> flush mounted accessory - to be purchased separately. Can be fitted with rainshield <a href="#">[343051]</a> - to be purchased separately. The pushbutton panel has a protection index IP54 - protection index against mechanical impact IK10. The indoor unit has 2 physical keys for the control of the main door entry functions - answer and end a call - and has 3 touch keys for the control of the main functions - door lock release, staircase light control and entrance panel activation/scrolling - there are further 4 configurable touch keys that perform different functions - e.g. intercom, additional door lock activation, generic activations. Ringtone volume adjustment (with call exclusion) using the appropriate selector. The installation can be made to the wall using the bracket supplied or using table support accessory (1 x <a href="#">344692</a> ) - to be purchased separately. The device also has Professional Studio (Office) function and must be configured.

Pack	Item	CLASSE 100A16M - LINEA 3000 AUDIO KIT WITH HAND SET
1	<a href="#">364231</a>	One-family audio kit with CLASSE 100A16M audio indoor unit and LINEA 3000 pushbutton panel with zamak front cover. Can be configured for one-family or two-family installations. Nameplate lit by white LED. Can be wall or flush installed with specific accessories: <a href="#">[350020]</a> flush mounted box with <a href="#">[343061]</a> flush mounted accessory - to be purchased separately. Can be fitted with rainshield <a href="#">[343051]</a> - to be purchased separately. The pushbutton panel has a protection index IP54 - protection index against mechanical impact IK10. The audio indoor unit has 3 touch keys for the control of the main functions - door lock release, staircase light control and entrance panel activation/scrolling - there are further 4 configurable touch keys that perform different functions - e.g. intercom, additional door lock activation, generic activations. Ringtone volume adjustment (with call exclusion) using the appropriate selector. The installation can be made to the wall using the bracket supplied or using table support accessory (1 x <a href="#">344692</a> ) - to be purchased separately. The device also has Professional Studio (Office) function and must be configured.

Item	KIT COMPOSITION	Qty
<a href="#">343071</a>	LINEA 3000 Audio entrance panel	1
<a href="#">344282</a>	CLASSE 100A16E Audio internal unit	1
<a href="#">346040</a>	6 DIN System power supply	1

Item	KIT COMPOSITION	Qty
<a href="#">343071</a>	LINEA 3000 Audio entrance panel	1
<a href="#">344292</a>	CLASSE 100A16M Audio internal unit	1
<a href="#">346040</a>	6 DIN System power supply	1





366811

366821



Pack	Item	SPRINT L2 - LINEA 2000 AUDIO handset audio kit
		Audio kit with audio handset SPRINT L2 and LINEA 2000 pushbutton panel. 2 WIRE technology. The audio handset has a door lock release pushbutton and a pushbutton that can be configured for auxiliary functions (staircase light switching on, entrance panel activation, call to the switchboard). Devices suitable for wall mounted installation. Expandable with additional audio handset 344242.
1	366811	Complete one-family kit
1	366821	Complete two-family kit

Item	KIT COMPOSITION	366811	366821
		Qty	Qty
342911	LINEA 2000 Entrance panel - 1 CALL	1	-
342921	LINEA 2000 Entrance panel - 2 CALLS	-	1
344232	SPRINT L2 audio handset	1	2
346040	6 DIN System power supply	1	1



364211

Pack	Item	AUDIO HANDSFREE - LINEA 2000
1	364211	One-family expandable audio kit with audio handsfree internal unit and LINEA 2000 pushbutton panel. The audio internal unit can manage with (1 - 2) pushbuttons on board two independent contacts (24 Vac/dc - 1 A max.) Entrance panel and internal unit are suitable for wall mounted installation. Expansion possibility using the specific additional handsfree internal unit 331650

Item	KIT COMPOSITION	Qty
342911	LINEA 2000 Entrance panel - 1 CALL	1
331650	Audio handsfree internal unit	1
346040	6 DIN System power supply	1

# GLOSSARY

## **AUTO-SWITCHING ON**

Functions providing audio and video communication between internal unit and entrance panel, or internal unit and outside the door unit, without a call being received.

## **BACKBONE**

It provides the connection between entrance panel and distributes the signal to.

## **CAT 5E AND CAT 6 CABLE**

Data transmission cables made up of four pairs arranged inside a sheath according to a specific layout, which is necessary to reduce attenuation and crosstalk problems. This layout consists of twisting the pairs of conductors individually. These pairs are identified using standard colours. Each of the pairs has a different pitch, and is in turn twisted differently inside the outer sheath.

The conductor size permitted by the standards is between 22 and 26 AWG: 24 AWG is the most commonly used in all cases and corresponds to a diameter of 0.5 mm.

The acronym AWG (American Wire Gauge) corresponds to the unit of measurement used by the American standards to measure the cross-sections of cables.

As it is a ratio, the smallest cross-sections correspond to the largest AWG sizes. The appropriateness of using cables with different types of sheath must be assessed according to the area in which the wiring system is installed.

The most commonly used cable sheath is PVC or LSZH (Low SmokeZero Halogen).

## **CONNECTED INTERNAL UNIT**

It is an internal unit which embeds a wi-fi module able to connect to a wi-fi network.

## **ENTRANCE PANEL**

Term used to indicate the device outside the building, from which the internal unit can be called.

## **FLOOR CALL**

Term used to indicate the call from an out of the door bell. Usually referred to an internal unit which has an additional contact for a direct connection with an out of the door door bell.

## **FLOOR SHUNT**

Hub for the connection of video/ audio and audio only internal units, apartment interfaces, and additional power supplies.

## **IN / OUT**

Connection of the devices where two clamps act as node between the IN twisted pair and the OUT twisted pair.

## **INTERCOM**

Function that provides audio communication between two internal units.

## **INTERNAL UNIT**

Individual video/audio or audio only device for the identification of the individual making the call from the entrance panel. Normally, in addition to communicating with the entrance panel, the internal unit also gives the possibility of performing other actions, such as the release of the door lock, intercom calls, automatic switching on, etc.

## **MASTER**

It is the video internal unit that turns on when a call is received.

## **RISER**

It is the set of vertical wiring connecting the internal units with the power supply.

## **SLAVE**

It is the video internal unit connected in parallel to the master video internal unit, and which rings but does not turn on when a call is received (it only turns on when the call is answered).

# THE TECHNICAL SHEETS

The technical sheets contain detailed information on the individual devices: external pushbutton panels, audio and video internal units and system accessories.

The information of the specific device is normally the following:

- description of the device;
- related items;
- technical and dimensional data;
- configuration details;
- specific functions;

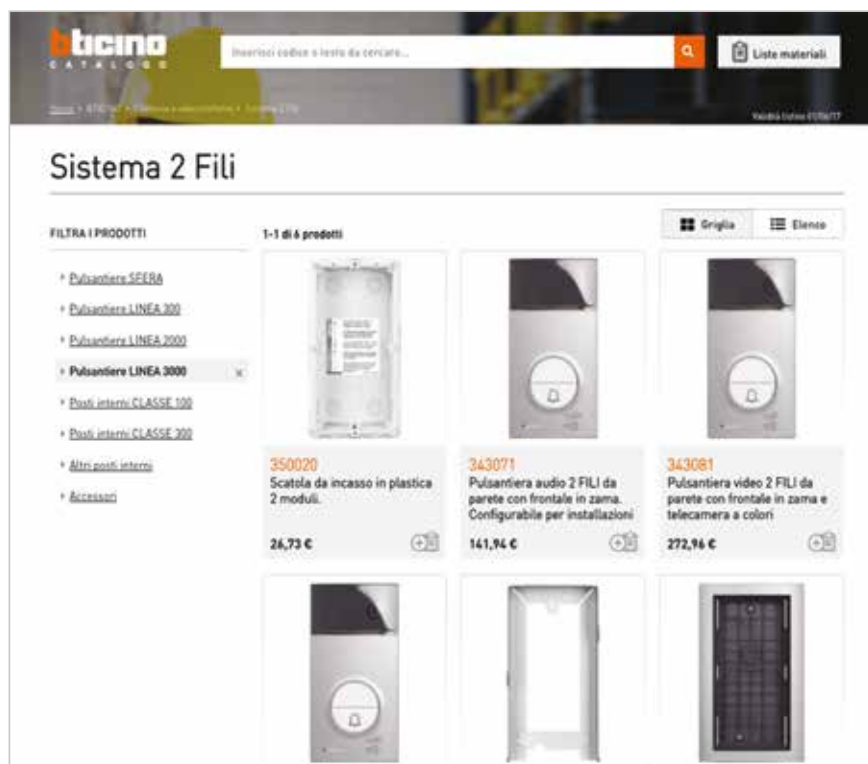

Technical sheets can be viewed and downloaded by accessing the on-line catalogue <https://catalogue.bticino.com/>



With the SEARCH function, by typing the code, you will be directed directly to the specific page of the requested item, where you can consult and download all the specific documents (technical sheet included).

**NOTE**

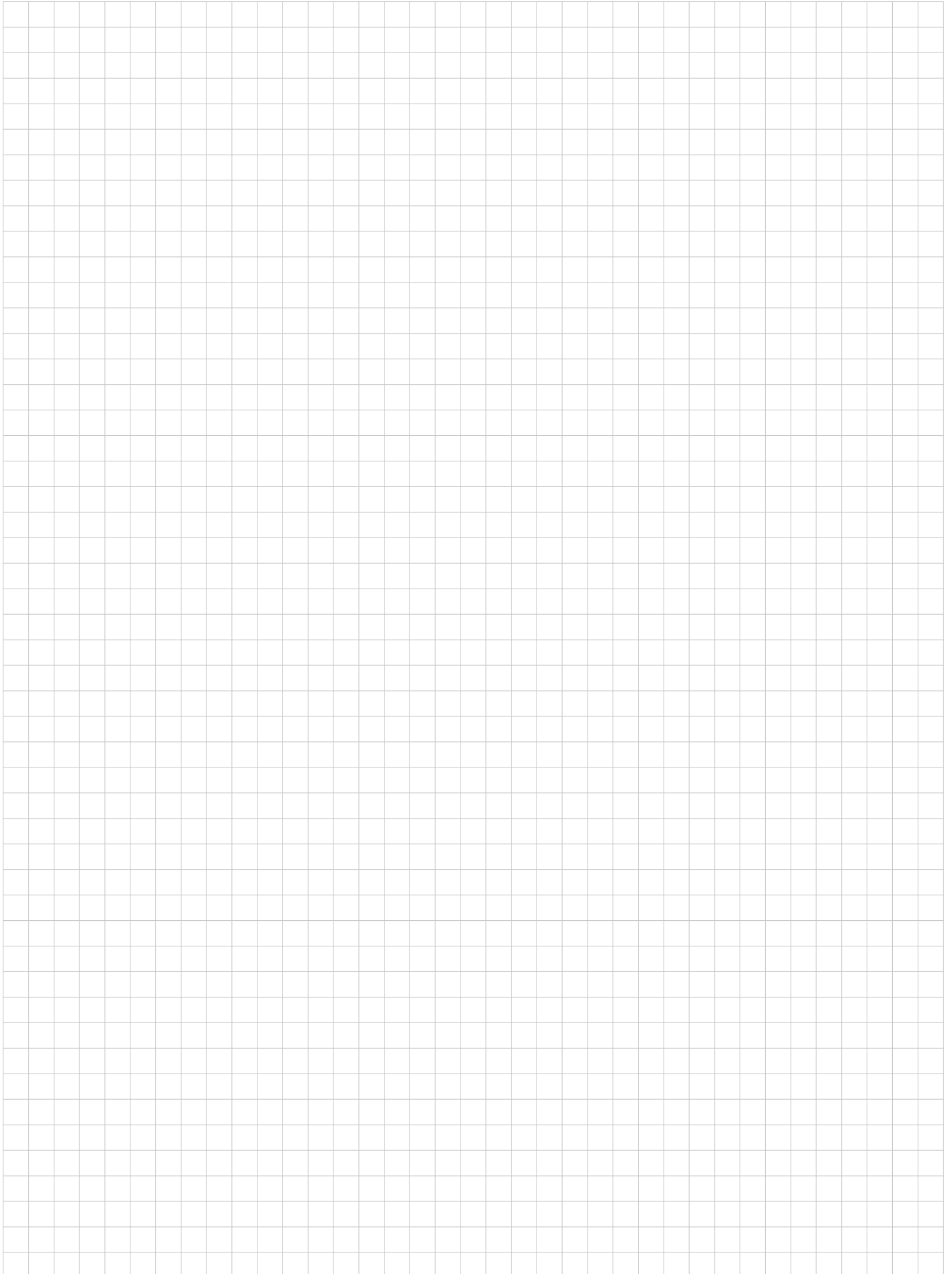

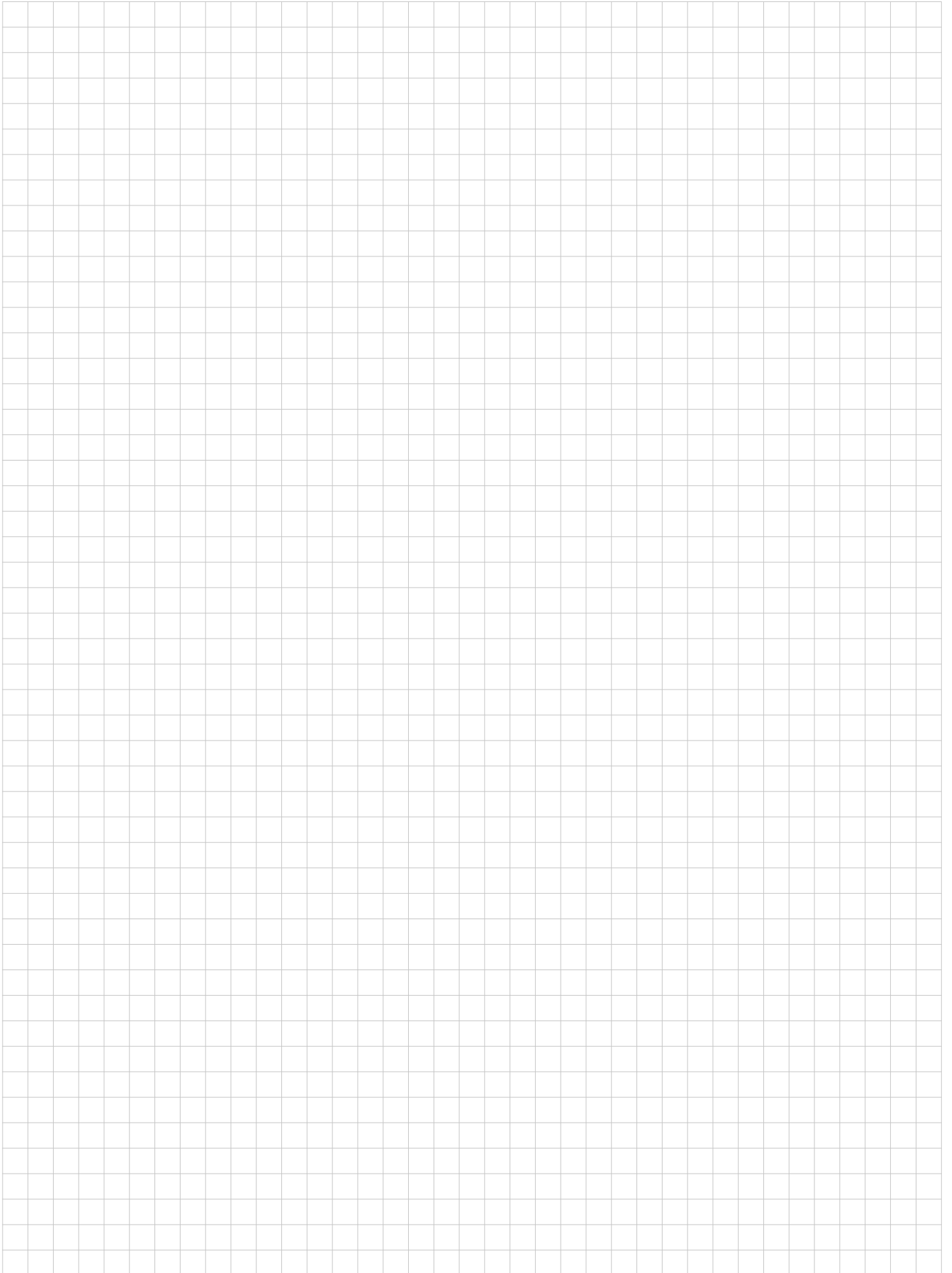

# NOTE

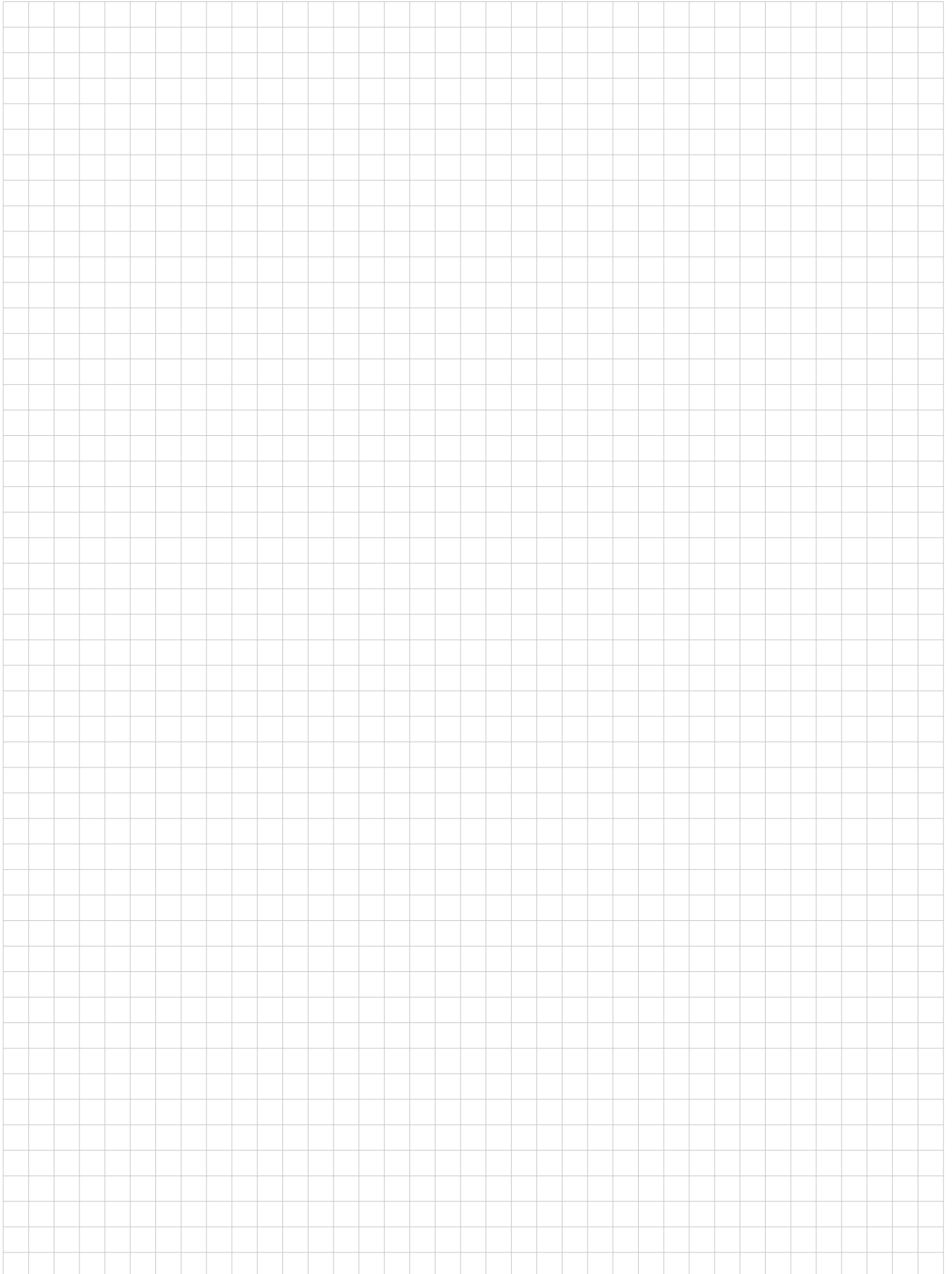

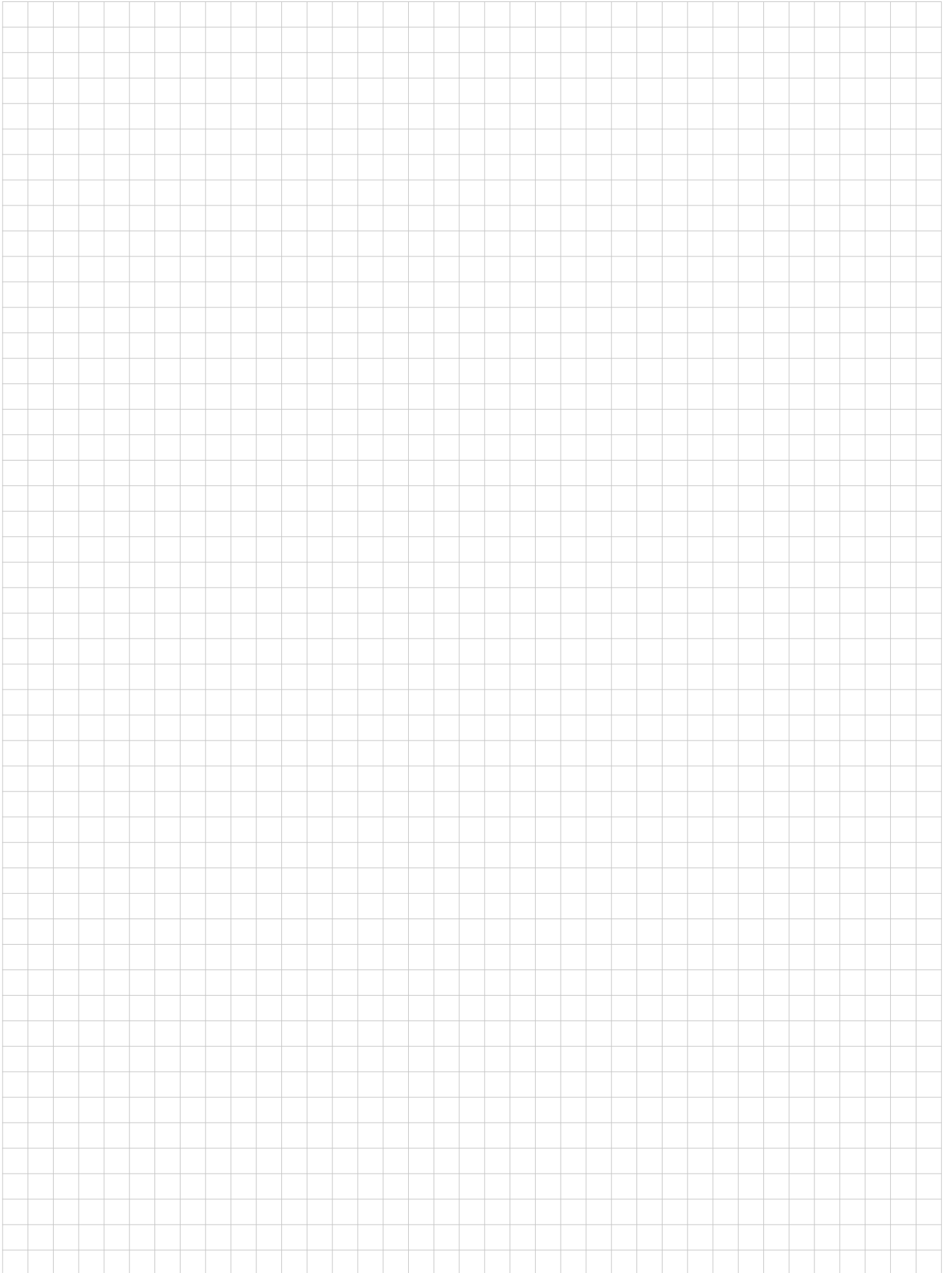

**BTicino** SpA  
Viale Borri, 231  
21100 Varese - Italy  
[www.bticino.com](http://www.bticino.com)