



AUDIO & VIDEO DOOR ENTRY SYSTEMS

CATALOGUE

KITS AND
SYSTEM SOLUTIONS
FOR SINGLE HOUSES,
BUILDINGS AND
COMPOUNDS



BTICINO

Specialists in Video Door Entry Systems

BTicino, introduces a complete range of products and systems capable of meeting all application and building requirements. From single homes to larger buildings and apartment complexes, BTicino can offer the right solution to satisfy both the private user and the professional.

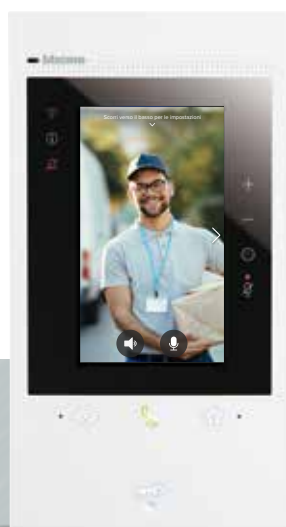

Index

4-5		
Offer overview	Different solutions for different applications	4
6-35		
EASY KITS	Plug-in EASY KITS (two wires)	8
	BASIC KITS (four wires)	26
36-47		
PROFESSIONAL KITS	The FULL EXPANDABLE solution	36
	Villa CONNECTED VIDEO KITS (two wires)	40
	Villa VIDEO KITS (two wires)	43
	Villa AUDIO KITS (two wires)	45
	Villa ANALOGUE AUDIO KITS	47
48-107		
2 Wires System	System overview	48
	Entrance panels range	53
	Internal units range	74
	System accessories range	102
108-129		
IP System	System overview	108
	Entrance panels range	122
	Internal units range	123
	Guard station and accessories range	124

DIFFERENT SOLUTIONS FOR DIFFERENT APPLICATIONS

From villas to
multi-family units ■ ■ ■



Villas



Small buildings



Building complex

■ ■ ■ Different types of constructions
mean different types of offer

EASY KITS

for standard level villas



Closed solution that provides **BASIC FUNCTIONS**, normally for simple systems:

- ONE OR TWO FAMILY HOMES
- READY MADE SOLUTIONS
- BASIC FUNCTIONS
- PLUG-IN OR INTERNAL POWER SUPPLY (DIRECT MAINS CONNECTION)

PROFESSIONAL KITS

for high level villas



Initial basic solution that **CAN DEVELOP** into a **MORE COMPLEX** and **CUSTOMISED** systems:

- ONE OR TWO-FAMILY HOMES
- READY MADE SOLUTIONS
- FULLY EXPANDABLES
- ENHANCED FUNCTIONS

2 WIRE SYSTEM

for small buildings



The best technology when **TIME SAVING** and **EASE of INSTALLATION** are required:

- SMALL BUILDINGS/HOMES
- EASY AND QUICK TO INSTALL
- MAXIMUM VERSATILITY
- PERFECT FOR REFURBISHMENTS

IP SYSTEM

for big constructions



System developed mainly to increase competitiveness in large projects, buildings and complexes.

- LARGER BUILDINGS AND COMPLEXES
- HIGH PERFORMANCES
- LONG DISTANCES AND HIGH NUMBER OF APARTMENTS
- INTEGRATED SECURITY FUNCTIONS

EASY SOLUTIONS

- Easy installation
- Expandability with additional internal units, entrance panel and CCTV camera
- 2 Wires and 4 Wires available solutions
- Door lock release key and intercom functions
- Connected Wi-Fi solutions



PLUG-IN “EASY” KITS

“very simple” solutions



Hands-free video kits comprising:

- a wall-mounting metal entrance panel (rainshield included) equipped with a colour camera and a LED lamp for the illumination of the field of view.
- a video colour display internal unit (plug-in power supply included).

MAIN FEATURES:

- Easy, simple and quick installation
- SMART wi-fi connected solution for your security
- 2 non-polarized wires for an error-proof connection
- Practical and functional: hands-free solutions enabling dialogue while moving freely
- High-resistant, waterproof metal entrance panels
- One family installation. Easy switch to two families by adding the additional internal unit
- Expandability with additional internal units, entrance panel and CCTV camera.

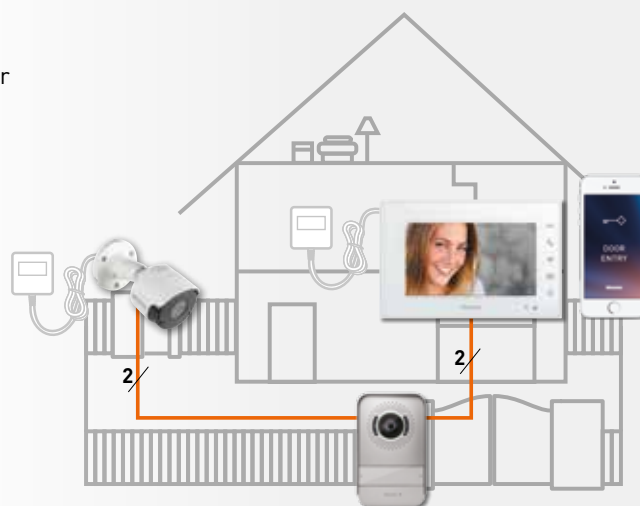

BASIC KITS

“cost-effective” solutions



Hands-free and handset audio and video kits comprising:

- a wall-mounting metal entrance panel with LEDs for the illumination of the field of view
- a video colour display internal unit with integrated power supply
- available in audio version

MAIN FEATURES:

- 4 Wires (video system)
3 Wires (audio system)
- Installation flexibility (integrated power supply)
- Expandability with additional internal units, entrance panel or CCTV camera

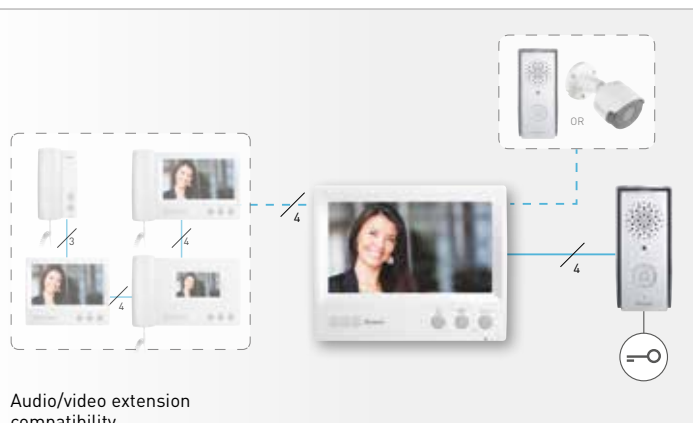

Plug-In “EASY” 2 WIRES



EASY KIT CONNECTED

SMART SOLUTION
FOR YOUR SECURITY



Video internal unit compatible
with NETATMO Smart Indoor and
Smart Outdoor cameras.



THE ADVANTAGES OF A CONNECTED SYSTEM



Answer and open the door
while you are comfortably seated
on your sofa or away from home



Open the gate without using
the keys when you get home



Don't miss a delivery
Take calls and open the gate,
wherever you are



Video surveillance
View cameras when
you are away from home

Plug-In “EASY” 2 WIRES



ONE APP FOR ALL YOUR CUSTOMER NEEDS

With **a single APP** you can answer calls wherever you are and view the images of all the cameras connected to the system, even those of Netatmo

Dedicated APP
DOOR ENTRY
EASY KIT



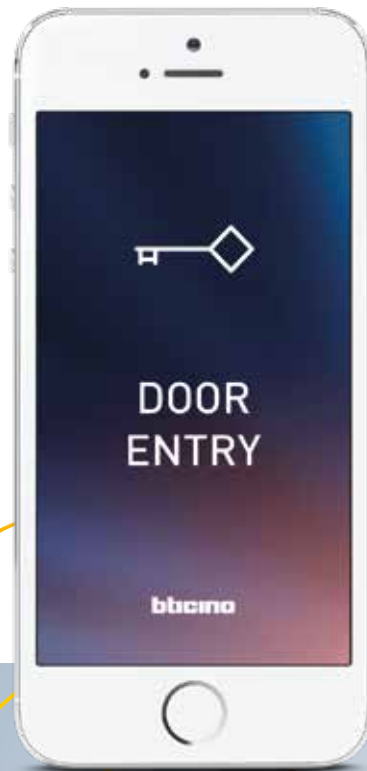

Additional CCTV Camera

Compatible with **Netatmo**

Video internal unit compatible with NETATMO Smart Indoor and Smart Outdoor cameras.



Video entrance panel



NETATMO Smart Indoor Camera



NETATMO Smart Outdoor Camera

Plug-In “EASY” 2 WIRES

You can **turn your existing system into a connected one** by simply **replacing the video internal unit** without structural changes.



ONE-FAMILY HOUSE



Existing internal unit



TWO-FAMILY HOUSE



Existing internal units





Compatible with
 **Netatmo**

Video internal unit compatible with NETATMO Smart Indoor and Smart Outdoor cameras.

Connected internal unit
BT-332851
BT-332855



PLUG-IN EASY SOLUTIONS

CHOOSE YOUR KIT...

7" WI-FI CONNECTED VIDEO KITS



- Call repetition on smartphone
- Wi-fi connected
- 7" colour LCD display
- Internal unit with white finish
- Internal unit with black finish
- Hands-free communication modality
- Lights activation
- Additional CCTV camera
- Entrance panel can call 2 apartments
- Integration with NETATMO's Smart Outdoor and Indoor Cameras

7" AND 10" TOUCH SCREEN VIDEO KITS



- 10" or 7" colour touch screen display
- Silver finish
- Hands-free communication modality
- Lights activation
- Clock screen saver
- Mp3 ringtones & digital photo frame (SD Card non included)
- Answering machine & visitor face capture
- Additional CCTV camera
- Entrance panel can call 2 apartments

7" MIRROR EFFECT / WHITE FINISH VIDEO KITS



- 7" colour LCD display
- Mirror or white finish
- Hands-free communication modality
- Lights activation
- Additional CCTV camera
- Entrance panel can call 2 apartments

4,3" VIDEO KIT



- 4.3" colour LCD display
- White finish
- Hands-free communication modality
- Additional CCTV camera
- Entrance panel can call 2 apartments

AND EXPAND IT

All PLUG-IN EASY KITS can be expanded up to a maximum of 3 internal units and one additional entrance panel or CCTV camera for each apartment. Only one easy kit connected per home can be installed.

7" WHITE/BLACK WI-FI CONNECTED FINISH INTERNAL UNITS



7" White finish



7" Black finish



7" AND 10" TOUCH SCREEN INTERNAL UNITS



7" Internal unit



10" Internal unit

7" MIRROR EFFECT / WHITE FINISH INTERNAL UNITS



7" Mirror effect



7" White finish

4,3" INTERNAL UNIT



ADDITIONAL ENTRANCE PANEL ADDITIONAL CAMERA





BASIC SOLUTIONS



CHOOSE YOUR KIT...

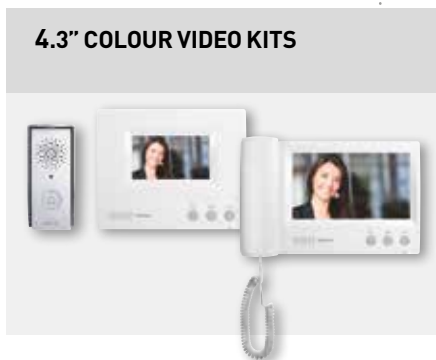

- 7" Hands-free and Handset kits
- Modern and trendy design
- Compact, discrete and robust entrance panels with rainshield
- Extended security thanks to the additional CCTV camera

- 4,3" Hands-free and handset kits
- Modern and trendy design
- Compact, discrete and robust entrance panels with rainshield
- Extended security thanks to the additional CCTV camera

- Audio Handset kit
- Modern and trendy design
- Compact, discrete and robust entrance panels with rainshield

AND EXPAND IT

All BASIC KITS can be expanded up to a maximum of 5 internal units. Video kits can be expanded with dedicated video and audio internal units and up to one additional entrance panel or an external CCTV camera.

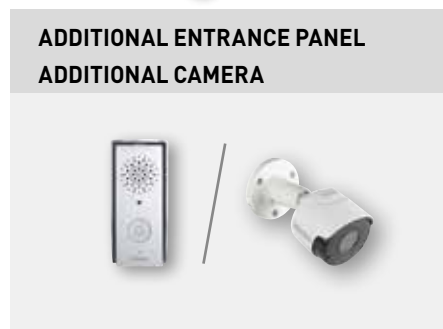
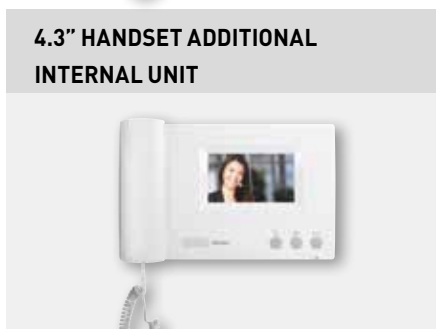
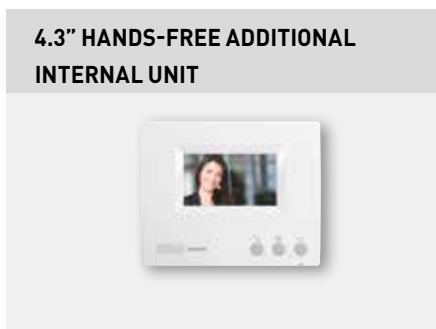
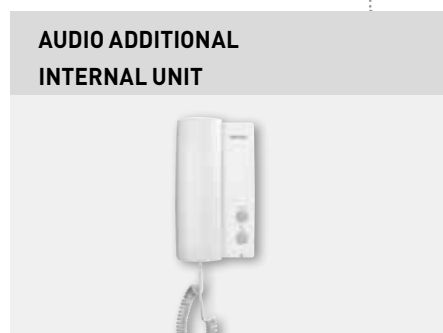
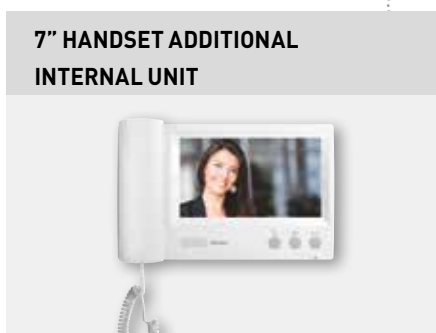
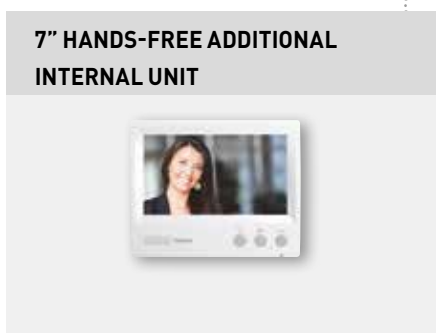

Plug-In "EASY" 2 WIRES



7" WHITE & BLACK FINISH WI-FI CONNECTED VIDEO KITS

ONE Family two wires colour WI-Fi connected video kits with wall mounted entrance panel. Metal finish entrance panel with rainshield, colour wide angle camera and LED for the night illumination of the field of view. Entrance panel can be easily adapted for two family houses.

An external CCTV colour camera can be directly connected to the entrance panel. Wi-Fi connected handsfree 7" screen internal unit with PLUG-IN power supply included. The system can be expanded up to 3 traditional handsfree internal units. Available in white and black finishes.

Thanks to the Wi-Fi connection, you can associate the video internal unit to the Door Entry Easy Kit App (available for Android and iOS). You can manage by the App the main video internal unit functions (receiving calls, opening the door lock, view the cameras). The system is fully interoperable with Netatmo cameras for greater security outside and inside the house.

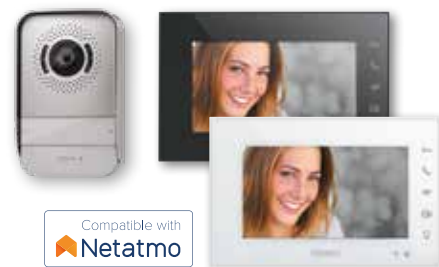

7" & 10" COLOUR TOUCH SCREEN VIDEO KITS

ONE Family two wires colour video kits with wall mounted entrance panel. Metal finish entrance panel with rainshield, colour wide angle camera and LED for the night illumination of the field of view. Entrance panel can be easily adapted for two family System.

An external CCTV colour camera can be directly connected to the entrance panel. Handsfree touch screen (7" and 10" versions) internal unit with audio & video memory, Mp3 ringtones and PLUG-IN power supply included.

It can be expanded with up to 3 dedicated handsfree internal units. Available in white and silver finishes.



7" MIRROR SCREEN & WHITE FINISH VIDEO KITS

ONE Family two wires colour video kits with wall mounted entrance panel. Metal finish entrance panel with rainshield, colour wide angle camera and LED for the night illumination of the field of view. Entrance panel can be easily adapted for two family System. An external CCTV colour camera can be directly connected to the entrance panel. Handsfree 7" mirror screen and white finish internal units with PLUG-IN power supply included. It can be expanded with up to 3 dedicated handsfree internal units.



4.3" COLOUR VIDEO KIT

ONE Family two wires colour video kit with wall mounted entrance panel. Metal finish entrance panel with rainshield, colour wide angle camera and LED for the night illumination of the field of view.

Entrance panel can be easily adapted for two family System. An external CCTV colour camera can be directly connected to the entrance panel. Handsfree 4.3" colour internal unit with PLUG-IN power supply included. White finish. It can be expanded with up to 3 dedicated handsfree internal units.





PLUG-IN STANDARD TYPE	7" WHITE KIT CONNECTED	7" BLACK KIT CONNECTED	10" TOUCH SCREEN	7" TOUCH SCREEN	7" MIRROR KIT	7" WHITE KIT	4.3" VIDEO KIT
European standard 	BT-318011 (7" Screen KIT connected)	BT-318015 (7" Screen KIT connected)	BT-317213 (10" Touch Screen KIT)	BT-317113 (7" Touch Screen KIT)	BT-317013 (7" Mirror Screen KIT)	BT-317014 (7" White screen KIT)	BT-316913 (4.3" KIT)
UL standard 	BT-332851 (Additional 7" connected Internal unit)	BT-332855 (Additional 7" connected Internal unit)	BT-332553 (Additional 10" Internal unit)	BT-332453 (Additional 7" Internal unit)	BT-332353 (Additional 7" mirror Internal unit)	BT-332354 Additional 7" white Internal unit)	BT-332253 (Additional 4.3" Internal unit)
Video colour entrance panel 	BT-331860 (Additional colour entrance panel with rainshield)						
Additional External camera 	BT-391441 (European standard PLUG Colour external camera)						
Spare part Power supply 	BT-SP101 (Spare part plug-in power supply)						



NOTE: internal units are all compatible. As additional internal unit you can use any of the range.

BTICINO BRAND KITS

PLUG-IN "EASY" 2 WIRES



BT-318011
BT-318012

BT-318015

BT-317213
BT-317211

BT-317113
BT-317111

BT-317013
BT-317011

BT-317014
BT-317012

Pack	Item	7" white & black finish connected video kits
		<p>Complete video kits</p> <p>ONE Family two wires colour WI-Fi connected video kits with wall mounted entrance panel. Metal finish entrance panel with rainshield, colour wide angle camera and LED for the night illumination of the field of view. Entrance panel can be easily adapted for two family houses. An external CCTV colour camera can be directly connected to the entrance panel. Wi-Fi connected handsfree 7" screen internal unit with PLUG-IN power supply included. The system can be expanded up to 3 traditional handsfree internal units. Available in white and black finishes.</p> <p>Thanks to the Wi-Fi connection, you can associate the video internal unit to the Door Entry Easy Kit App (available for Android and iOS). You can manage by the App the main video internal unit functions (receiving calls, opening the door lock, view the cameras).</p> <p>The system is fully interoperable with Netatmo cameras for greater security outside and inside the house.</p> <p>(PLUG IN versions: European and UL Standards)</p>
1	BT-318011	7" White finish connected video kit with European standard PLUG-IN
1	BT-318012	7" Black finish connected video kit with European standard PLUG-IN
1	BT-318015	7" White finish connected video kit with UL standard PLUG-IN
		<p>Additional video internal units</p>
1	BT-332851	Connected 7" white finish additional internal unit 7" with European standard PLUG-IN
1	BT-332852	Connected 7" white finish additional internal unit 7" with UL standard PLUG-IN
1	BT-332855	Connected 7" black finish additional internal unit 7" with European standard PLUG-IN

Pack	Item	7" and 10" Touch screen video kits
		<p>Complete video kits</p> <p>ONE Family two wires colour video kits with wall mounted entrance panel . Metal finish entrance panel with rainshield, colour wide angle camera and LED for the night illumination of the field of view. Entrance panel can be easily adapted for two family System. An external CCTV colour camera can be directly connected to the entrance panel. Handsfree touch screen (7" and 10" versions) internal unit with audio & video memory, Mp3 ringtones and PLUG-IN power supply included. It can be expanded with up to 3 dedicated handsfree internal units. (PLUG IN versions: European and UL Standards).</p>
1	BT-317213	10" Touch screen complete kit with European standard PLUG-IN
1	BT-317211	10" Touch screen complete kit with UL standard PLUG-IN
1	BT-317113	7" Touch screen complete kit with European standard PLUG-IN
1	BT-317111	7" Touch screen complete kit with UL standard PLUG-IN
		<p>Additional video internal units</p>
1	BT-332553	10" Touch screen European standard PLUG-IN additional internal unit
1	BT-332551	10" Touch screen UL standard PLUG-IN additional internal unit
1	BT-332453	7" Touch screen European standard PLUG-IN additional internal unit
1	BT-332451	7" Touch screen UL standard PLUG-IN additional internal unit
		<p>7" Mirror and white video kits</p> <p>Complete video kits</p> <p>ONE Family two wires colour video kits with wall mounted entrance panel . Metal finish entrance panel with rainshield, colour wide angle camera and LED for the night illumination of the field of view. Entrance panel can be easily adapted for two family System. An external CCTV colour camera can be directly connected to the entrance panel. Handsfree 7" mirror screen and white screen colour internal unit with PLUG-IN power supply included. It can be expanded with up to 3 dedicated handsfree internal units. (PLUG IN versions:European and UL Standards).</p>
1	BT-317013	7" Mirror effect complete kit with European standard PLUG-IN
1	BT-317011	7" Mirror effect complete kit with UL standard PLUG-IN
1	BT-317014	7" White screen complete kit with European standard PLUG - IN
1	BT-317012	7" White screen complete kit with UL standard PLUG - IN

wiring diagram example



BT-316913
BT-316911



BT-331860



BT-391441

Pack	Item	7" Mirror and white video kits
		Additional video internal units
1	BT-332353	7" Mirror effect European standard PLUG-IN additional internal unit
1	BT-332351	7" Mirror effect UL standard PLUG-IN additional internal unit
1	BT-332354	7" White screen European standard PLUG-IN additional internal unit
1	BT-332352	7" White screen UL standard PLUG-IN additional internal unit
		4.3" Colour video kits
		Complete video kits
		ONE Family two wires colour video kits with wall mounted entrance panel .Metal finish entrance panel with rainshield, colour wide angle camera and LED for the night illumination of the field of view. Entrance panel can be easily adapted for two family System. An external CCTV colour camera can be directly connected to the entrance panel. Handsfree 4.3" colour internal unit with PLUG-IN power supply included.White finish. It can be expanded with up to 3 dedicated handsfree internal units. (PLUG IN versions: European and UL Standards).
1	BT-316913	4.3" Colour complete kit with European standard PLUG-IN
1	BT-316911	4.3" Colour complete kit with UL standard PLUG-IN
		Additional video internal units
1	BT-332253	4.3" Colour European standard PLUG-IN additional internal unit
1	BT-332251	4.3" Colour UL standard PLUG-IN additional internal unit
		Additional entrance panel & camera
1	BT-331860	Additional video colour entrance panel with rainshield. IP54 protection degree. Wide angle colour camera (95°). Additional colour external camera. Can be connected directly to the entrance panel. IP66 protection degree. Night vision. (PLUG IN versions: European and UL Standards).
1	BT-391441	European standard PLUG-IN additional camera
		Spare part power supply
1	BT-SP101	Spare part PLUG-IN power supply

7" and 10" Touch screen video kits

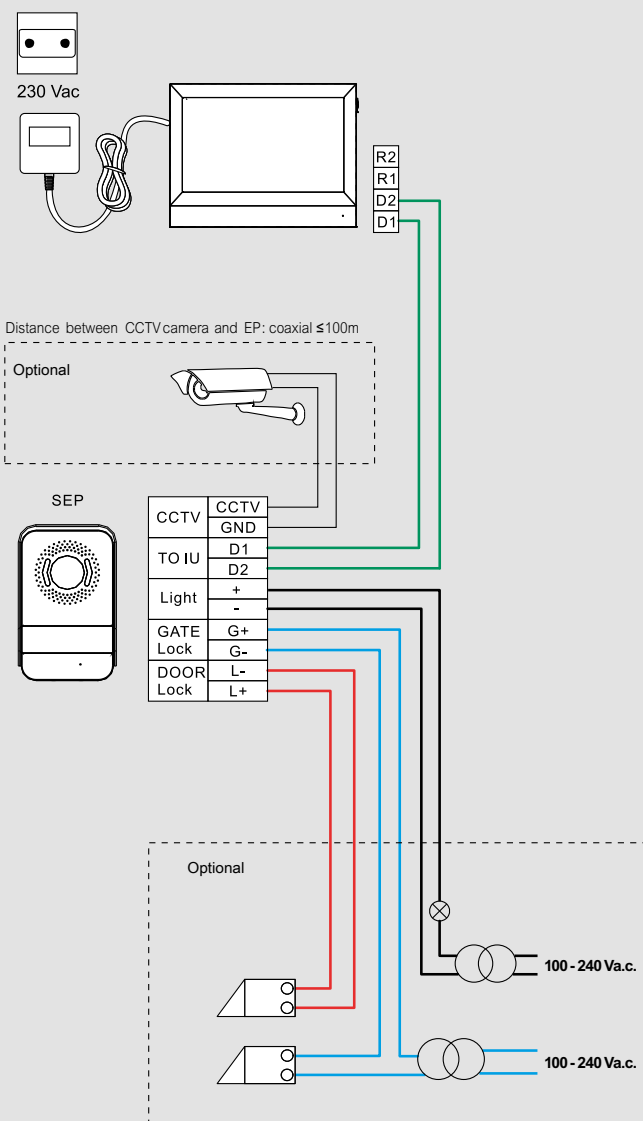

Plug-In "EASY" 2 WIRES



7" WHITE & BLACK FINISH WI-FI CONNECTED VIDEO KITS

ONE Family two wires colour WI-Fi connected video kits with wall mounted entrance panel. Metal finish entrance panel with rainshield, colour wide angle camera and LED for the night illumination of the field of view. Entrance panel can be easily adapted for two family houses.

An external CCTV colour camera can be directly connected to the entrance panel. Wi-Fi connected handsfree 7" screen internal unit with PLUG-IN power supply included. The system can be expanded up to 3 traditional handsfree internal units. Available in white and black finishes.

Thanks to the Wi-Fi connection, you can associate the video internal unit to the Door Entry Easy Kit App (available for Android and iOS). You can manage by the App the main video internal unit functions (receiving calls, opening the door lock, view the cameras).

The system is fully interoperable with Netatmo cameras for greater security outside and inside the house.

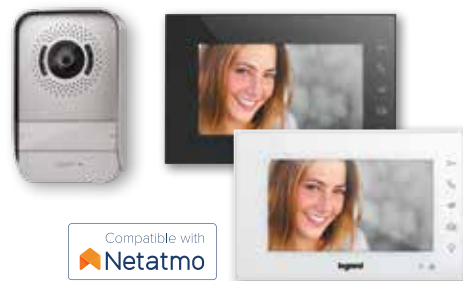

7" & 10" COLOUR TOUCH SCREEN VIDEO KITS

ONE Family two wires colour video kits with wall mounted entrance panel. Metal finish entrance panel with rainshield, colour wide angle camera and LED for the night illumination of the field of view.

Entrance panel can be easily adapted for two family System. An external CCTV colour camera can be directly connected to the entrance panel. Handsfree touch screen (7" and 10" versions) internal unit with audio & video memory, Mp3 ringtones and PLUG-IN power supply included. It can be expanded with up to 3 dedicated handsfree internal units. Available in white and silver finishes.



7" MIRROR SCREEN & WHITE FINISH VIDEO KITS

ONE Family two wires colour video kits with wall mounted entrance panel. Metal finish entrance panel with rainshield, colour wide angle camera and LED for the night illumination of the field of view. Entrance panel can be easily adapted for two family System.

An external CCTV colour camera can be directly connected to the entrance panel. Handsfree 7" mirror screen and white finish internal units with PLUG-IN power supply included. It can be expanded with up to 3 dedicated handsfree internal units.







4.3" COLOUR VIDEO KIT

ONE Family two wires colour video kit with wall mounted entrance panel. Metal finish entrance panel with rainshield, colour wide angle camera and LED for the night illumination of the field of view.

Entrance panel can be easily adapted for two family System. An external CCTV colour camera can be directly connected to the entrance panel. Handsfree 4.3" colour internal unit with PLUG-IN power supply included. White finish. It can be expanded with up to 3 dedicated handsfree internal units.

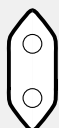



PLUG-IN STANDARD TYPE	7" WHITE KIT CONNECTED	7" BLACK KIT CONNECTED	10" TOUCH SCREEN	7" TOUCH SCREEN	7" MIRROR KIT	7" WHITE KIT	4.3" VIDEO KIT
European standard 	LG -369420 (7" Screen KIT connected)	LG -369430 (7" Screen KIT connected)	LG-369330 (10" Touch Screen KIT)	LG-369320 (7" Touch Screen KIT)	LG-369220 (7" Mirror Screen KIT)	LG-369230 (7" White screen KIT)	LG-369110 (4.3" KIT)
	LG -369425 (Additional 7" connected Internal unit)	LG -369435 (Additional 7" connected Internal unit)	LG-369335 (Additional 10" Internal unit)	LG-369325 (Additional 7" Internal unit)	LG-369225 (Additional 7" mirror Internal unit)	LG-369235 Additional 7" white Internal unit)	LG-369115 (Additional 4.3" Internal unit)
Video colour entrance panel 	LG-369339 (Additional colour entrance panel with rainshield)						
Additional External camera 	LG-369401 (European standard PLUG colour external camera)						
Spare part Power supply 	BT-SP101 (Spare part plug-in power supply)						

NOTE: internal units are all compatible. As additional internal unit you can use any of the range.



LEGRAND BRAND KITS

PLUG-IN "EASY" 2 WIRES



LG-369420

LG-369430

LG-369330

LG-369320

LG-369220

LG-369230

Pack	Item	7" white & black finish connected video kits
		<p>Complete video kits ONE Family two wires colour WI-Fi connected video kits with wall mounted entrance panel. Metal finish entrance panel with rainshield, colour wide angle camera and LED for the night illumination of the field of view. Entrance panel can be easily adapted for two family houses. An external CCTV colour camera can be directly connected to the entrance panel. Wi-Fi connected handsfree 7" screen internal unit with PLUG-IN power supply included. The system can be expanded up to 3 traditional handsfree internal units. Available in white and black finishes. Thanks to the Wi-Fi connection, you can associate the video internal unit to the Door Entry Easy Kit App (available for Android and iOS). You can manage by the App the main video internal unit functions (receiving calls, opening the door lock, view the cameras). The system is fully interoperable with Netatmo cameras for greater security outside and inside the house. (PLUG IN version: European Standard)</p>
1	LG-369420	7" White finish connected video kit with European standard PLUG-IN
1	LG-369430	7" Black finish connected video kit with European standard PLUG-IN
		<p>Additional video internal units</p>
1	LG-369425	Connected 7" white finish additional internal unit 7" with European standard PLUG-IN
1	LG-369435	Connected 7" black finish additional internal unit 7" with European standard PLUG-IN

Pack	Item	7" and 10" Touch screen video kits
		<p>Complete video kits ONE Family two wires colour video kits with wall mounted entrance panel . Metal finish entrance panel with rainshield, colour wide angle camera and LED for the night illumination of the field of view. Entrance panel can be easily adapted for two family System. An external CCTV colour camera can be directly connected to the entrance panel. Handsfree touch screen (7" and 10" versions) internal unit with audio & video memory, Mp3 ringtones and PLUG-IN power supply included. It can be expanded with up to 3 dedicated handsfree internal units. (PLUG IN version: European Standard).</p>
1	LG-369330	10" Touch screen complete kit with European standard PLUG-IN
1	LG-369320	7" Touch screen complete kit with European standard PLUG-IN
		<p>Additional video internal units</p>
1	LG-369335	10" Touch screen European standard PLUG-IN additional internal unit
1	LG-369325	7" Touch screen European standard PLUG-IN additional internal unit
		<p>7" Mirror and white video kits</p>
		<p>Complete video kits ONE Family two wires colour video kits with wall mounted entrance panel . Metal finish entrance panel with rainshield, colour wide angle camera and LED for the night illumination of the field of view. Entrance panel can be easily adapted for two family System. An external CCTV colour camera can be directly connected to the entrance panel. Handsfree 7" mirror screen and white screen colour internal unit with PLUG-IN power supply included. It can be expanded with up to 3 dedicated handsfree internal units. (PLUG IN version: European Standard).</p>
1	LG-369220	7" Mirror effect complete kit with European standard PLUG-IN
1	LG-369230	7" White screen complete kit with European standard PLUG - IN
		<p>Additional video internal units</p>
1	LG-369225	7" Mirror effect European standard PLUG-IN additional internal unit
1	LG-369235	7" White screen European standard PLUG-IN additional internal unit

wiring diagram example



LG-369110



LG-369339



LG-369401

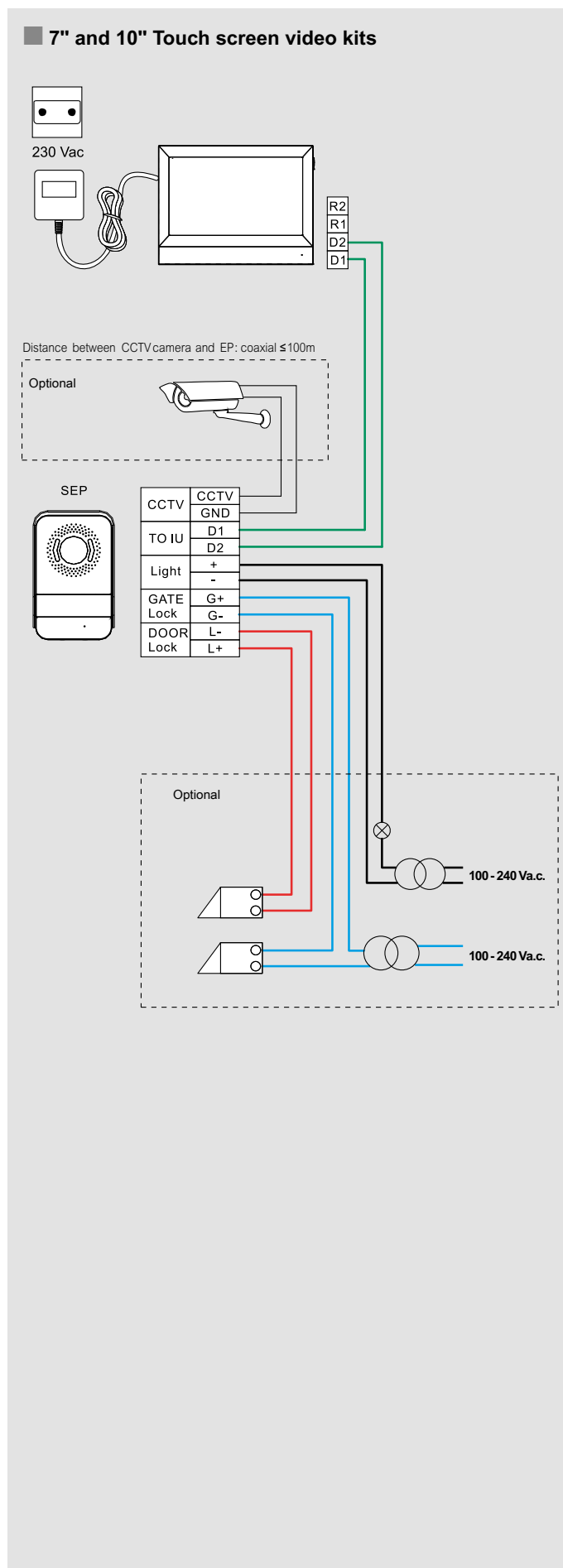

Pack	Item	4.3" Colour video kits
		<p>Complete video kits</p> <p>ONE Family two wires colour video kits with wall mounted entrance panel .Metal finish entrance panel with rainshield, colour wide angle camera and LED for the night illumination of the field of view. Entrance panel can be easily adapted for two family System. An external CCTV colour camera can be directly connected to the entrance panel. Handsfree 4.3" colour internal unit with PLUG-IN power supply included.White finish. It can be expanded with up to 3 dedicated handsfree internal units.</p> <p>(PLUG IN version: European Standard).</p>
1	LG-369110	4.3" Colour complete kit with European standard PLUG-IN
1	LG-369115	<p>Additional video internal units</p> <p>4.3" Colour European standard PLUG-IN additional internal unit</p>
1	LG-369339	<p>Additional entrance panel & camera</p> <p>Additional video colour entrance panel with rainshield. IP54 protection degree. Wide angle colour camera (95°)</p>
1	LG-369401	<p>Additional colour external camera. Can be connected directly to the entrance panel. IP66 protection degree. Night vision.</p> <p>(PLUG IN version: European Standard).</p>
1	BT-SP101	<p>Spare part power supply</p> <p>Spare part PLUG-IN power supply</p>



Plug-In "EASY" 2 WIRES

WIRING DIAGRAMS

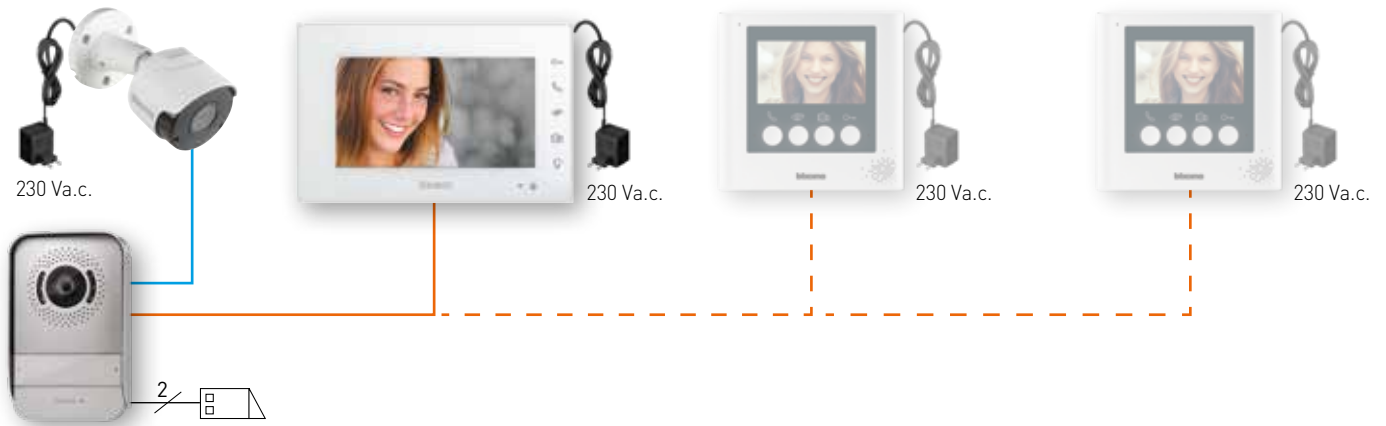

EXAMPLE 1 - SINGLE FAMILY SYSTEM WITH ONE ENTRANCE PANEL

-  2 WIRES connection
-  COAX connection



NOTE: - Internal units are all compatible. As additional internal unit you can use any of the range
 - If necessary, to control the electrical door lock release, use a transformer BT-336842 (230 Va.c.)

EXAMPLE 2 - SINGLE FAMILY SYSTEM WITH TWO ENTRANCE PANELS

-  2 WIRES connection
-  COAX connection

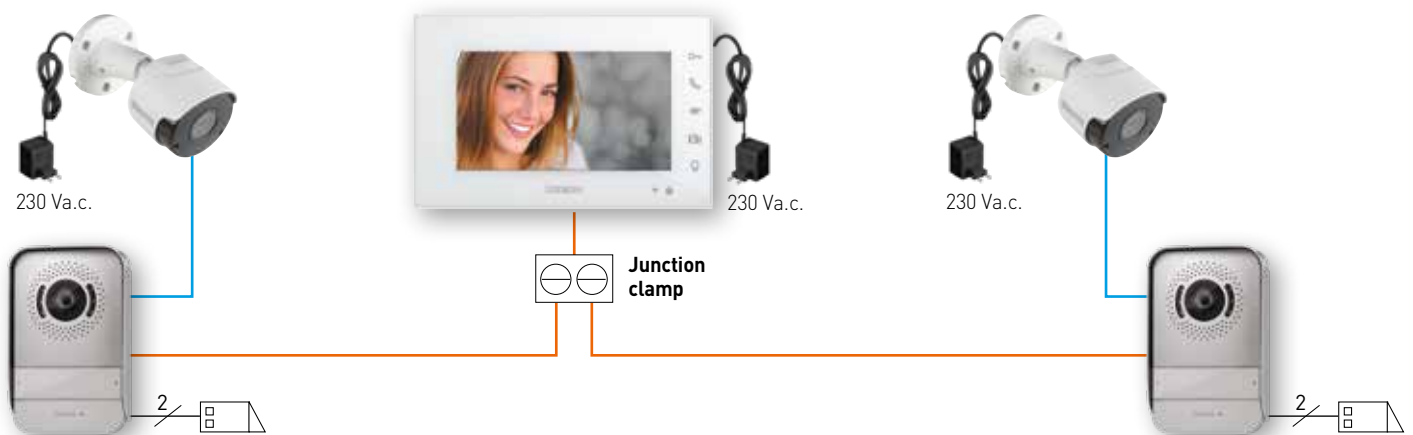

NOTE: if necessary, to control the electrical door lock release, use DIN Transformer BT-336842 (230 Va.c.)

EXAMPLE 3 – TWO FAMILY SYSTEM WITH ONE ENTRANCE PANEL

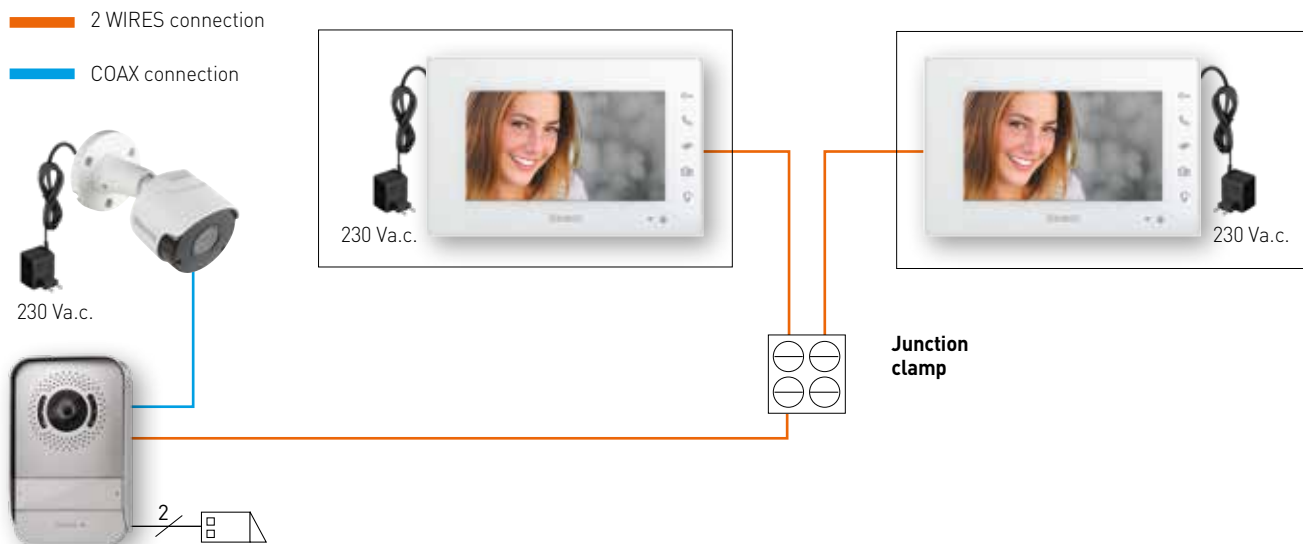

NOTE: if necessary, to control the electrical door lock release, use DIN Transformer BT-336842 (230 Va.c.)

EXAMPLE 4 – TWO FAMILY SYSTEM WITH TWO ENTRANCE PANELS

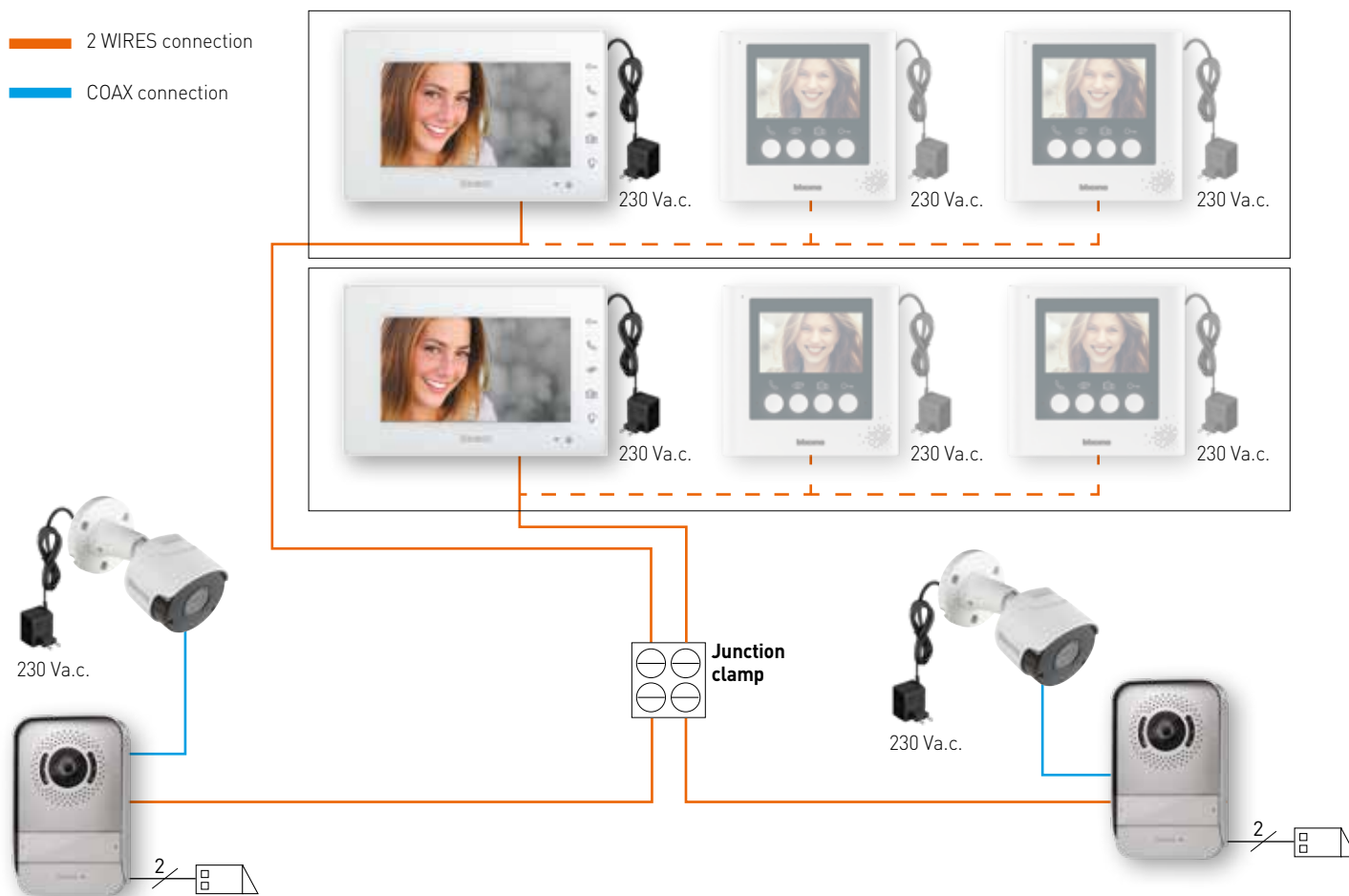

NOTE: - Internal units are all compatible. As additional internal unit you can use any of the range
 - If necessary, to control the electrical door lock release, use a transformer BT-336842 (230 Va.c.)

BASIC 4 WIRES



7" COLOUR VIDEO KITS

7" Hands-free and Handset video kits

ONE-FAMILY 4-wires colour video hands-free and handset kits, wall mounted with internal power supply, expandable up to 4 additional internal units and up to 1 additional entrance panel or a CCTV camera, offering the basic door entry system functions: call, intercom, door lock activation, image cycling. Composed of a hands-free or handset internal unit, with a 7" colour display and 12 ringtones, signaling LED and MUTE function; and a discrete Zamak entrance panel with rain-shield, microphone and speaker volume adjustments, colour camera and LED for enhancing lighting in the visual field.



4.3" COLOUR VIDEO KITS

4.3" Hands-free and Handset video kits

ONE-FAMILY 4-wires colour video hands-free and handset kits, wall mounted with internal power supply, expandable up to 4 additional internal units and up to 1 additional entrance panel or a CCTV camera, offering the basic door entry system functions: call, intercom, door lock activation, image cycling. Composed of a hands-free or handset internal unit, with a 4.3" colour display and 12 ringtones, signaling LED and MUTE function; and a discrete Zamak entrance panel with rain-shield, microphone and speaker volume adjustments, colour camera and LED for enhancing lighting in the visual field.







HANDSET AUDIO KIT

Handset audio kit

ONE-FAMILY 4-wires handset audio kit, wall mounted with internal power supply, expandable up to 4 additional internal units, offering the basic door entry system functions: call, intercom, door lock activation. Composed of a handset audio internal unit, signaling LED and MUTE function; and a discrete Zamak entrance panel with rain-shield, microphone and speaker volume adjustments.





	7" VIDEO KITS	4.3" VIDEO KITS	AUDIO KIT
Kit 	BT-315511 (7" Hands-free kit) BT-315411 (7" Handset kit)	BT-315311 (4.3" Hands-free kit) BT-315211 (4.3" Handset kit)	BT-315111 (Handset kit)
Additional internal units 	BT-330851 (Additional 7" Handsfree internal unit) BT-330751 (Additional 7" Handset internal unit)	BT-330651 (Additional 4.3" Handsfree internal unit) BT-330551 (Additional 4.3" Handset internal unit)	BT-330451 (Additional audio handset)
NOTE: internal units are all compatible. As additional internal unit you can use any of the range.			
Additional entrance panels 	BT-330560 (Additional video entrance panel with rainshield) BT-330460 (Additional audio entrance panel with rainshield) BT-330660 (Entrance panel angle bracket accessory)		
Additional external cameras 	BT-391441 (Additional external camera - European standard)		



BTICINO BRAND

BASIC KITS



BT-315511



BT-315411



BT-315311



BT-315211



BT-315111

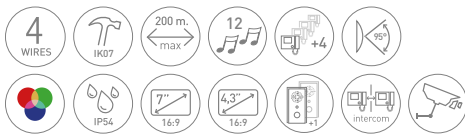

Pack	Item	7" Video kits
1		ONE-FAMILY 4-wires colour video hands-free or handset kit, wall mounted with internal power supply, expandable up to 4 additional Internal Units and up to 1 additional External Panel or an External Camera (NTSC or PAL), offering the following functions: call, intercom, door lock activation, image cycling. Composed of a hands-free or a handset Video Internal Unit, with a 7" colour display and 12 ringtones, signaling LED and MUTE function; and a discrete Zamak Entrance Panel, with rain-shield, microphone and speaker volume adjustments, colour camera and LED for enhancing lighting in the visual field.
1	BT-315511	7" Hands-free video kit
1	BT-315411	7" Handset video kit
1		4.3" Video kits
1		ONE-FAMILY 4-wires colour video hands-free or handset kit, wall mounted with internal power supply, expandable up to 4 additional Internal Units and up to 1 additional External Panel or an External Camera (NTSC or PAL), offering the following functions: call, intercom, door lock activation, image cycling. Composed of a hands-free or a handset Video Internal Unit, with a 4,3" colour display, signaling LED and MUTE function; and a discrete Zamak Entrance Panel, with rain-shield, microphone and speaker volume adjustments, colour camera and LED for enhancing lighting in the visual field.
1	BT-315311	4.3" Hands-free video kit
1	BT-315211	4.3" Handset video kit

Pack	Item	Audio kit
1		ONE-FAMILY 3-wires handset Audio kit, wall mounted with internal power supply, expandable up to 4 additional Internal Units, offering the following functions: call, intercom, door lock activation. Composed of a handset Audio Internal Unit, signaling LED and MUTE function; and a discrete Zamak Entrance Panel with rain-shield, microphone and speaker volume adjustments.
1	BT-315111	Handset audio kit



Pack	Item	Additional 7" Video Internal Units
1	BT-330851	Colour video hands-free additional Internal Unit, recommended to expand a ONE FAMILY BASIC 4-wires Video Kit, wall mounted with internal power supply, a 7" colour display and 12 ringtones, signaling LED and MUTE function, offering the following functions: call, intercom, door lock activation, image cycling.
1	BT-330751	Colour video handset additional internal unit, recommended to expand a ONE FAMILY BASIC 4-wires Video Kit, wall mounted with internal power supply, a 7" colour display and 12 ringtones, signaling LED and MUTE function, offering the following functions: call, intercom, door lock activation, image cycling.
Additional 4.3" Video Internal Units		
1	BT-330651	Colour video hands-free additional Internal Unit, recommended to expand a ONE FAMILY BASIC 4-wires Video Kit, wall mounted with internal power supply, a 4,3" colour display and 12 ringtones, signaling LED and MUTE function, offering the following functions: call, intercom, door lock activation, image cycling.
1	BT-330551	Colour video handset additional Internal Unit, recommended to expand a ONE FAMILY BASIC 4-wires Video Kit, wall mounted with internal power supply, a 4,3" colour display and 12 ringtones, signaling LED and MUTE function, offering the following functions: call, intercom, door lock activation, image cycling.
Additional Audio handset Internal Unit		
1	BT-330451	Audio handset additional Internal Unit, recommended to expand ONE FAMILY BASIC Video or Audio Kit, wall mounted with internal power supply, signaling LED and MUTE function, offering the following functions: call, intercom and door lock activation.

Pack	Item	Additional Video Entrance Panel
1	BT-330560	Additional Zamak Entrance Panel, recommended to expand a ONE FAMILY BASIC 4-wires Video Kit, wall mounted with embedded rain-shield, microphone and speaker volume adjustments, colour camera and LED for enhancing lighting in the visual field.
Additional Audio Entrance Panel		
1	BT-330460	Additional Zamak Entrance Panel, recommended to expand a ONE FAMILY BASIC Audio or Video Kit, wall mounted with embedded rain-shield, microphone and speaker volume adjustments.
Angle Bracket accessory		
1	BT-330660	Accessory for the installation of the External Panels BT-330560 - BT-330460 to adjust its visual field by a 30°-angle, to the right or to the left.
Additional External Camera		
1	BT-391441	External colour camera, IP66 Protection Degree, PAL video system, with plug-in power supply included. European standard plug version

BASIC 4 WIRES



7" COLOUR VIDEO KITS

7" Hands-free and Handset video kits

ONE-FAMILY 4-wires colour video hands-free and handset kits, wall mounted with internal power supply, expandable up to 4 additional internal units and up to 1 additional entrance panel or a CCTV camera, offering the basic door entry system functions: call, intercom, door lock activation, image cycling. Composed of a hands-free or handset internal unit, with a 7" colour display and 12 ringtones, signaling LED and MUTE function; and a discrete Zamak entrance panel with rain-shield, microphone and speaker volume adjustments, colour camera and LED for enhancing lighting in the visual field.



4.3" COLOUR VIDEO KITS

4.3" Hands-free and Handset video kits

ONE-FAMILY 4-wires colour video hands-free and handset kits, wall mounted with internal power supply, expandable up to 4 additional internal units and up to 1 additional entrance panel or a CCTV camera, offering the basic door entry system functions: call, intercom, door lock activation, image cycling. Composed of a hands-free or handset internal unit, with a 4.3" colour display and 12 ringtones, signaling LED and MUTE function; and a discrete Zamak entrance panel with rain-shield, microphone and speaker volume adjustments, colour camera and LED for enhancing lighting in the visual field.







HANDSET AUDIO KIT

Handset audio kit

ONE-FAMILY 4-wires handset audio kit, wall mounted with internal power supply, expandable up to 4 additional internal units, offering the basic door entry system functions: call, intercom, door lock activation. Composed of a handset audio internal unit, signaling LED and MUTE function; and a discrete Zamak entrance panel with rain-shield, microphone and speaker volume adjustments.





	7" VIDEO KITS	4.3" VIDEO KITS	AUDIO KIT
Kit 	LG-369580 (7" Hands-free kit) LG-369570 (7" Handset kit)	LG-369560 (4.3" Hands-free kit) LG-369550 (4.3" Handset kit)	LG-369500 (Handset kit)
Additional internal units 	LG-369585 (7" Hands-free additional video internal unit) LG-369575 (7" Handset additional video internal unit)	LG-369565 (4.3" Hands-free additional video internal unit) LG-369555 (4.3" Handset additional video internal unit)	LG-369505 (Handset additional audio internal unit)
NOTE: internal units are all compatible. As additional internal unit you can use any of the range.			
Additional entrance panels 	LG-369596 (Additional video entrance panel with rainshield) LG-369595 (Additional audio entrance panel with rainshield) LG-369597 (Entrance panel angle bracket accessory)		
Additional external camera 	LG-369401 (Additional external camera - European standard)		



LEGRAND BRAND

BASIC KITS



LG-369580



LG-369570



LG-369560



LG-369550



LG-369500

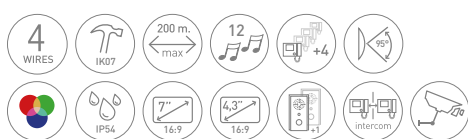

Pack	Item	7" Video kits
1		ONE-FAMILY 4-wires colour video hands-free or handset kit, wall mounted with internal power supply, expandable up to 4 additional Internal Units and up to 1 additional External Panel or an External Camera (NTSC or PAL), offering the following functions: call, intercom, door lock activation, image cycling. Composed of a hands-free or a handset Video Internal Unit, with a 7" colour display and 12 ringtones, signaling LED and MUTE function; and a discrete Zamak Entrance Panel, with rain-shield, microphone and speaker volume adjustments, colour camera and LED for enhancing lighting in the visual field.
1	LG-369580	7" Hands-free video kit
1	LG-369570	7" Handset video kit

Pack	Item	4.3" Video kits
1		ONE-FAMILY 4-wires colour video hands-free or handset kit, wall mounted with internal power supply, expandable up to 4 additional Internal Units and up to 1 additional External Panel or an External Camera (NTSC or PAL), offering the following functions: call, intercom, door lock activation, image cycling. Composed of a hands-free or a handset Video Internal Unit, with a 4,3" colour display, signaling LED and MUTE function; and a discrete Zamak Entrance Panel, with rain-shield, microphone and speaker volume adjustments, colour camera and LED for enhancing lighting in the visual field.
1	LG-369560	4.3" Hands-free video kit
1	LG-369550	4.3" Handset video kit

Pack	Item	Audio kit
1		ONE-FAMILY 3-wires handset Audio kit, wall mounted with internal power supply, expandable up to 4 additional Internal Units, offering the following functions: call, intercom, door lock activation. Composed of a handset Audio Internal Unit, signaling LED and MUTE function; and a discrete Zamak Entrance Panel with rain-shield, microphone and speaker volume adjustments.
1	LG-369500	Handset audio kit



Pack	Item	Additional 7" Internal Units
1	LG-369585	Colour video hands-free additional Internal Unit, recommended to expand a ONE FAMILY BASIC 4-wires Video Kit, wall mounted with internal power supply, a 7" colour display and 12 ringtones, signaling LED and MUTE function, an External Camera (NTSC or PAL), offering the following functions: call, intercom, door lock activation, image cycling.
1	LG-369575	Colour video handset additional internal unit, recommended to expand a ONE FAMILY BASIC 4-wires Video Kit, wall mounted with internal power supply, a 7" colour display and 12 ringtones, signaling LED and MUTE function, an External Camera (NTSC or PAL), offering the following functions: call, intercom, door lock activation, image cycling.
Additional 4.3" Internal Units		
1	LG-369565	Colour video hands-free additional Internal Unit, recommended to expand a ONE FAMILY BASIC 4-wires Video Kit, wall mounted with internal power supply, a 4,3" colour display and 12 ringtones, signaling LED and MUTE function, an External Camera (NTSC or PAL), offering the following functions: call, intercom, door lock activation, image cycling.
1	LG-369555	Colour video handset additional Internal Unit, recommended to expand a ONE FAMILY BASIC 4-wires Video Kit, wall mounted with internal power supply, a 4,3" colour display and 12 ringtones, signaling LED and MUTE function, an External Camera (NTSC or PAL), offering the following functions: call, intercom, door lock activation, image cycling.
Additional audio handset Internal Unit		
1	LG-369505	Audio handset additional Internal Unit, recommended to expand ONE FAMILY BASIC Video or Audio Kit, wall mounted with internal power supply, signaling LED and MUTE function, offering the following functions: call, intercom and door lock activation.

Pack	Item	Additional video Entrance Panel
1	LG-369596	Additional Zamak Entrance Panel, recommended to expand a ONE FAMILY BASIC 4-wires Video Kit, wall mounted with embedded rain-shield, microphone and speaker volume adjustments, colour camera and LED for enhancing lighting in the visual field.
Additional audio Entrance Panel		
1	LG-369595	Additional Zamak Entrance Panel, recommended to expand a ONE FAMILY BASIC Audio or Video Kit, wall mounted with embedded rain-shield, microphone and speaker volume adjustments
Angle bracket accessory		
1	LG-369597	Accessory for the installation of the External Panels LG-369596 - LG-369595 to adjust its visual field by a 30°-angle, to the right or to the left.
Additional External Camera		
1	LG-369401	External colour camera, IP66 Protection Degree, PAL video system, with plug-in power supply included. European standard plug version

BASIC 4 WIRES



WIRING DIAGRAMS

EXAMPLE 1 - SINGLE FAMILY STANDARD VIDEO SYSTEM

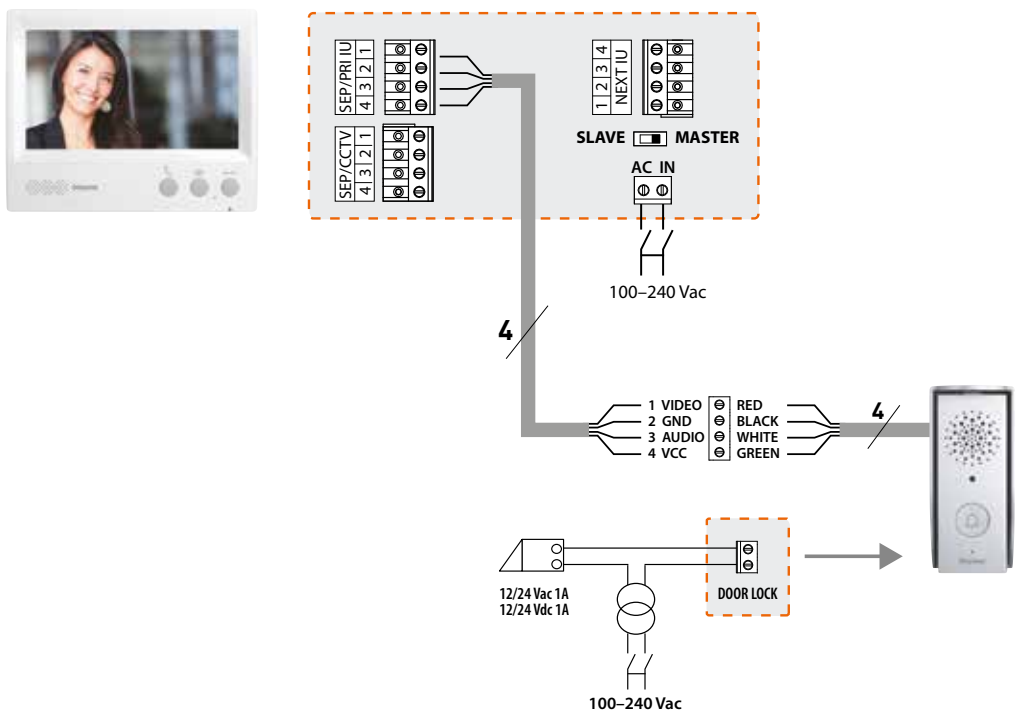

EXAMPLE 2 - SINGLE FAMILY STANDARD AUDIO SYSTEM

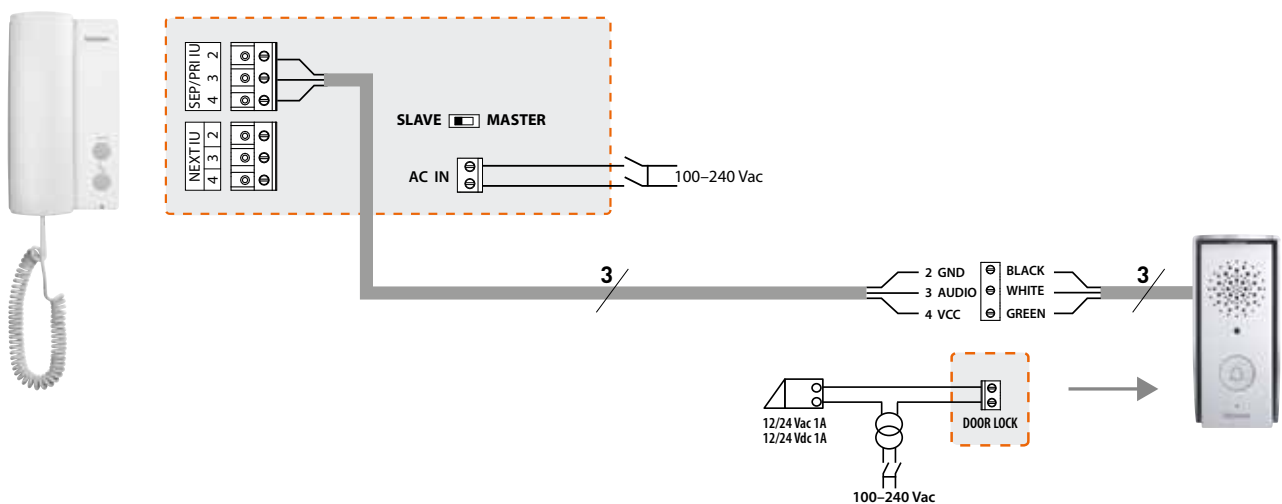



EXAMPLE 3 - SINGLE FAMILY VIDEO SYSTEM – MAXIMUM EXPANSION WITH CAMERA

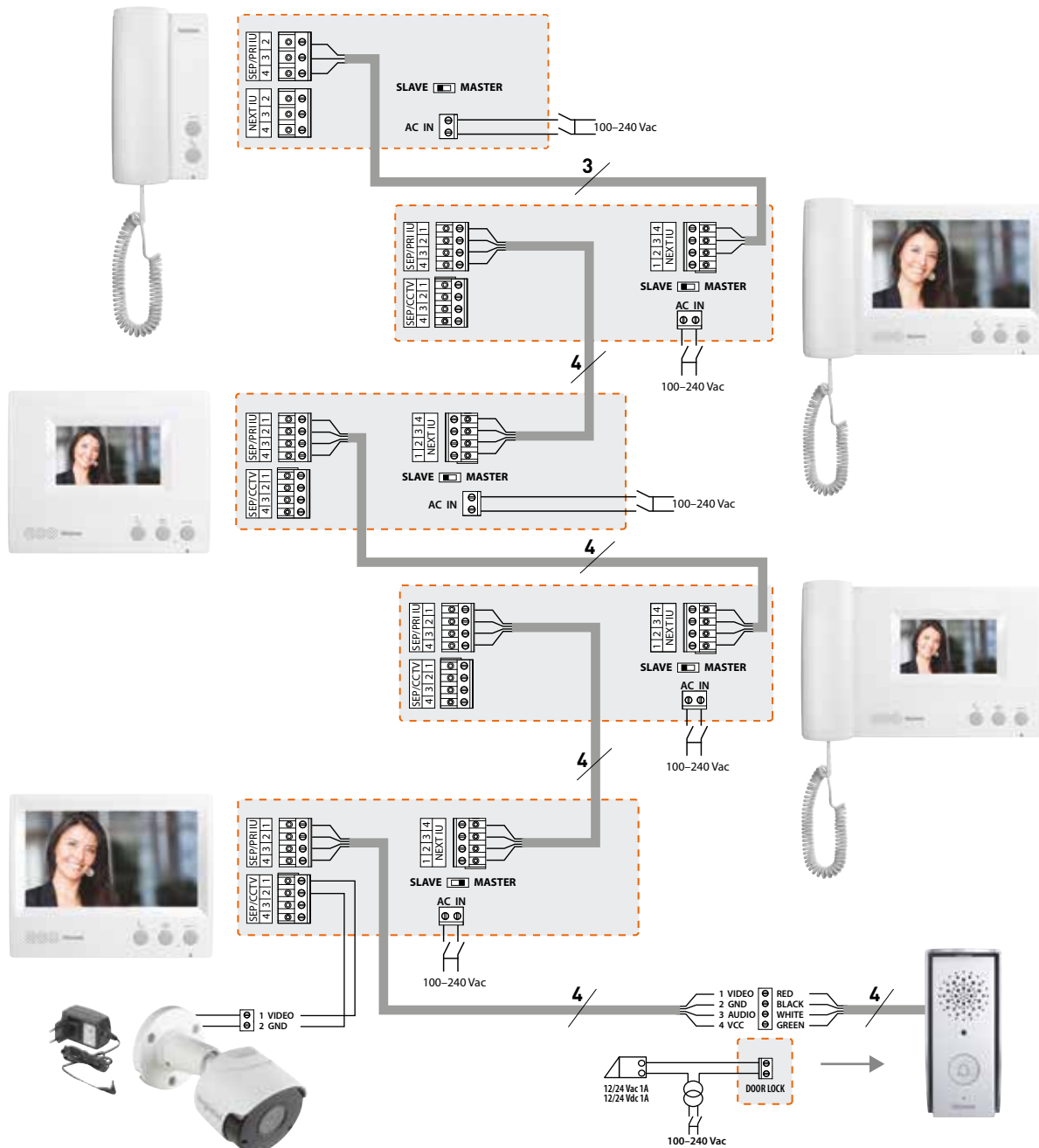

THE “FULL EXPANDABLE” SOLUTION



- The 2-wire technology allows maximum flexibility and expandability
- From basic functions to advanced functions such as call redirection on smartphone, video door entry answering machine, Netatmo cameras integration, intercom and door opening with badge
- Modular DIN-rail power supply
- Include a manual with all the technical information required for the installation, connection, features and expansion possibilities.



EXPANSION

Expand these kits with other devices such as additional entrance panels, internal units, cameras, and home automation devices.



AUDIO KITS



VIDEO KITS



SUITABLE FOR VILLA STANDARD - HIGH LEVEL APPLICATIONS

CLASSE 300E05



alexia | built-in

H + S



Netatmo
Smart Outdoor
camera

Call redirection
on smartphone



LINEA 3000



Door opening
with badge



Maximum simplicity

The 2 Wires professional kits guarantee maximum simplicity and flexibility of installation. They are the ideal solution for making new systems and in renovations. Both audio and video systems require only 2 WIRES for the

installation, so that existing wires can be used in the renovations. There is no need to respect polarity in the connections, giving maximum simplification in the installation work.



AUDIO KIT



LINEA 3000 ONE FAMILY AUDIO KIT – INSTALLATION EXAMPLE

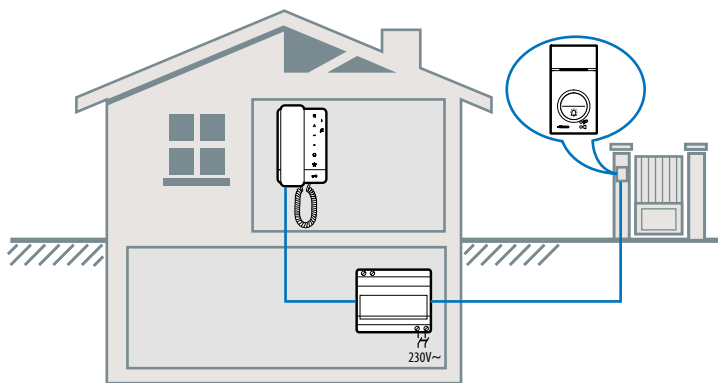

ONE FAMILY AUDIO KIT 364231



Two family
One family

LINEA 3000
ENTRANCE PANEL



POWER SUPPLY



CLASSE 100
AUDIO INTERNAL UNIT





VIDEO KIT

The 2 Wires kits are completely expandable and adapt to all installation needs.

They are perfectly compatible with the 2 devices (external pushbutton panels, internal units, video internal units, system accessories and cameras), allowing expansion without compromises.

LINEA 3000 TWO FAMILY VIDEO KIT – INSTALLATION EXAMPLE

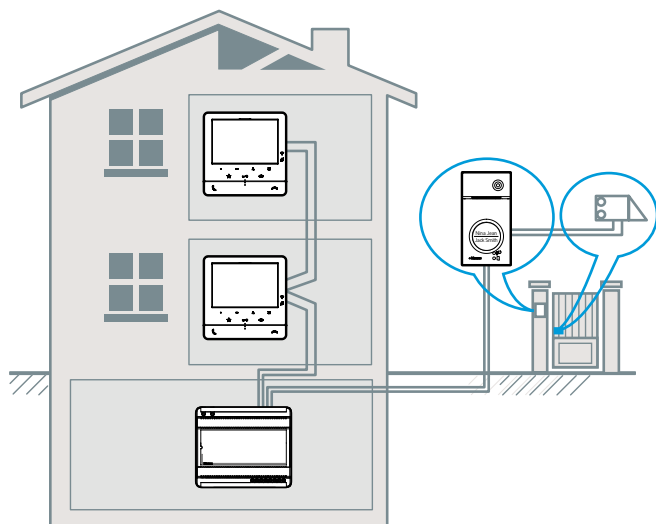

ADDITIONAL INTERNAL UNIT 344672

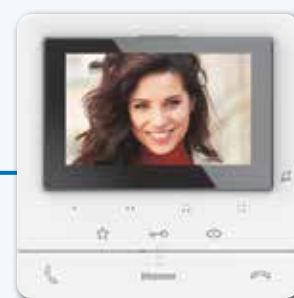

CLASSE 100 VIDEO INTERNAL UNIT

2/

ONE FAMILY VIDEO KIT 364612



Two family
One family

LINEA 3000 ENTRANCE PANEL

POWER SUPPLY



CLASSE 100 VIDEO INTERNAL UNIT

2/

PROFESSIONAL KITS

VILLA CONNECTED VIDEO KITS



363950

Note: Packaging graphics are subject to changes / updates.

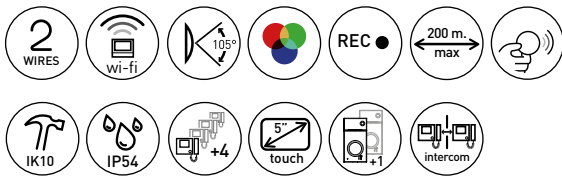

Pack	Item	CLASSE 300EOS - LINEA 3000 - NETATMO SMART OUTDOOR CAMERA CONNECTED KIT
1	363950	<p>One-family kit with Classe 300EOS handsfree connected video internal unit, LINEA 3000 pushbutton panel in black finish and Netatmo Smart Outdoor Camera.</p> <p>2 wires/Wi-Fi handsfree connected video internal unit with Teleloop, built-in Amazon Alexa voice assistant, 5" vertical touch screen LCD display and video door entry answering machine. Easy interaction with the built-in Alexa voice assistant, either using the dedicated capacitive keys or with your voice, and activate several functions, such as the video door entry functions, Smart Home, scenarios, reminders etc. Thanks to the Wi-Fi connectivity, you can associate the video internal unit to the Home + Security App (available for Android and iOS).</p> <p>The App allows to use the main video internal unit functions (receiving calls, door lock release, display of the event timeline and activation of the entrance panel/camera cycling). With the Home + Security App, it is also possible to manage the products of Netatmo security range (outdoor and indoor cameras, door and window sensors, indoor siren, smoke detector). This allows you to quickly and easily create a Smart security system. The device also allows to create and manage Smart Home functions, using the wired SCS BUS solution or the Zigbee solution, without the need for adding dedicated gateways.</p> <p>LINEA 3000 pushbutton panel with black finish zamak front cover, wide angle colour camera and proximity reader and with a kit of coloured key cards and two clear discs for door lock release. Can be wall or flush installed with specific accessories: (350020) flush mounted box and (343063) flush mounted accessory - to be purchased separately.</p> <p>Can be fitted with rainshield (343053) - to be purchased separately. The pushbutton panel has a protection index IP54- protection index against mechanical impact IK10.</p> <p>Smart Outdoor Security Camera with LED lighting spotlight, night vision and motion detection – send real time notification on smartphone in case of unknown person or vehicle detection.</p> <p>Complete one family kit (Easy switch to two families system by purchasing an additional internal unit - refer to 2 Wires system internal units range).</p>

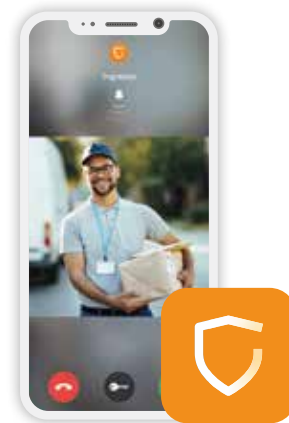

HOME + SECURITY is the App that allows, through the smartphone, to manage calls locally and remotely of the video door phone or with a simple touch to open the gate, the activation of the cameras, and switching on of the timed lights in the garden. Allows you to activate and view images of Netatmo Smart Outdoor and Indoor Cameras. Setting up the App requires a few steps and thanks to the BTicino Cloud, the remote connection is fully automated and managed with the highest level of security.

Item	KIT COMPOSITION	Qty
343093	LINEA 3000 pushbutton panel	1
344842	CLASSE 300EOS video internal unit	1
NOC-PRO	Smart Outdoor Camera	1
346050	6 DIN SCS power supply	1
346250	Door lock relay accessory	1
348260	Set of coloured door lock release key cards	1
348261	Set of door lock release clear discs	1



363915

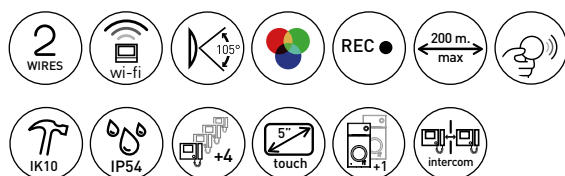

Pack **Item** **CLASSE 300EOS WITH NETATMO – LINEA 3000 CONNECTED VIDEO KIT**

One-family kit with Classe 300EOS handsfree connected video internal unit and LINEA 3000 pushbutton panel in black finish.
 2 wires/Wi-Fi handsfree connected video internal unit with built-in Amazon Alexa voice assistant, 5" vertical touch screen LCD display and video door entry answering machine. Easy interaction with the built-in Alexa voice assistant, either using the dedicated capacitive keys or with your voice, and activate several functions, such as the video door entry functions, Smart Home, scenarios, reminders etc. Thanks to the Wi-Fi connectivity, you can associate the video internal unit to the Home + Security App (available for Android and iOS).

The App allows to use the main video internal unit functions (receiving calls, door lock release, display of the event timeline and activation of the entrance panel/camera cycling). With the Home + Security App, it is also possible to manage the products of Netatmo security range (outdoor and indoor cameras, door and window sensors, indoor siren, smoke detector). This allows you to quickly and easily create a Smart security system. The device also allows to create and manage Smart Home functions, using the wired SCS BUS solution or the Zigbee solution, without the need for adding dedicated gateways.
 LINEA 3000 pushbutton panel with black finish zamak front cover, wide angle colour camera and proximity reader and with a kit of coloured key cards and two clear discs for door lock release. Can be wall or flush installed with specific accessories: (350020) flush mounted box and (343063) flush mounted accessory - to be purchased separately.
 Can be fitted with rainshield (343053) - to be purchased separately. The pushbutton panel has a protection index IP54- protection index against mechanical impact IK10.

1 363915 **Complete one family kit**
 (Easy switch to two families system by purchasing an additional internal unit - refer to 2 Wires system internal units range).



HOME + SECURITY is the App that allows, through the smartphone, to manage calls locally and remotely of the video door phone or with a simple touch to open the gate, the activation of the cameras, and switching on of the timed lights in the garden. Allows you to activate and view images of Netatmo Smart Outdoor and Indoor Cameras. Setting up the App requires a few steps and thanks to the BTicino Cloud, the remote connection is fully automated and managed with the highest level of security.

Item	KIT COMPOSITION	Qty
343093	LINEA 3000 pushbutton panel	1
344842	CLASSE 300EOS video internal unit	1
346050	6 DIN SCS power supply	1
346250	Door lock relay accessory	1
348260	Set of coloured door lock release key cards	1
348261	Set of door lock release clear discs	1

PROFESSIONAL KITS

VILLA CONNECTED VIDEO KITS



364614



Pack	Item	CLASSE 100X16E - LINEA 3000 CONNECTED VIDEO KIT
1	364614	<p>One-family handsfree kit with: CLASSE 100X16E Wi-Fi connected video indoor unit, handsfree function, inductive loop, 5» LCD display; LINEA 3000 pushbutton panel with zamak front cover, wide angle colour camera, proximity reader and with a set of coloured key cards and two clear discs for door lock release. Can be configured for one-family and two-family installations. It can manage a maximum of 20 key cards (125 KHz) for the electric door lock release (including the one for the system management). Nameplate lit by white LED. Can be wall or flush installed with specific accessories: (350020) flush mounted box and (343061) flush mounted accessory - to be purchased separately. Can be fitted with rainshield (343051)- to be purchased separately. The pushbutton panel has a protection index IP54- protection index against mechanical impact IK10. The video indoor unit has inductive loop function (to enable use by people wearing hearing aids fitted with T selector). It has 2 physical keys for the control of the main functions – answer and end a call – and has 3 touch keys for the control of the main functions – door lock release, staircase light control and entrance panel activation/scrolling – there are further 4 configurable touch keys that perform different functions – e.g. intercom, additional door lock activation, generic activations. It has a side lever to adjust: colour, brightness and display contrast, audio volume, call tone volume and Wi-Fi configuration. There are call exclusion notification LEDs and Wi-Fi. Also, thanks to the Wi-Fi connection, you can associate the video indoor unit to the Door Entry App (available for Android and iOS). You can manage the main video indoor unit functions (receiving calls, opening the door lock, activating the entrance panel/scrolling, firmware updating and additional activations) from the App. The installation can be made to the wall using the bracket supplied or using table support accessories (2 x 344692) – to be purchased separately. The device also has Professional Studio (Office) function and must be configured.</p> <p>Complete one family kit (Easy switch to two families system by purchasing an additional internal unit - refer to 2 Wires system internal units range).</p>



DOOR ENTRY CLASSE 100X is the App which lets you, using your smartphone, manage the video internal unit calls locally and remotely or with a simple touch open the gate, activate the cameras and switch the garden timed lights on. Configuring the App needs just a few steps and, thanks to the BTicino Cloud, the remote connection is totally automated and managed with the maximum level of security.

ATTENTION:
the **DOOR ENTRY CLASSE 100X** app will migrate to the new **HOME + SECURITY** app in the year 2022.

Item	KIT COMPOSITION	Qty
343091	LINEA 3000 Entrance panel	1
344682	CLASSE 100X16E Video internal unit	1
346050	6 DIN System power supply	1
346250	Relay module accessory	1
348260	Set of door lock release badges	1
348261	Set of door lock release clear discs	1

VILLA VIDEO KITS



364612

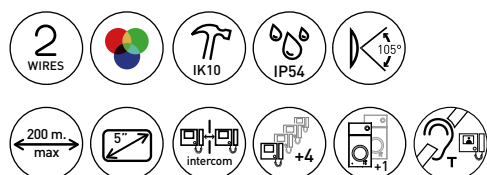

Pack	Item	CLASSE 100V16E - LINEA 3000 VIDEO KIT
1	364612	<p>Complete one family kit (Easy switch to two families system by purchasing an additional internal unit - refer to 2 Wires system internal units range).</p> <p>One-family handsfree kit with CLASSE 100V16E video indoor unit and LINEA 3000 pushbutton panel with zamak front cover and wide angle colour camera. Can be configured for one-family or two-family installations. Nameplate lit by white LED. Can be wall or flush installed with specific accessories: (350020) flush mounted box with (343061) flush mounted accessory - to be purchased separately. Can be fitted with rainshield (343051) - to be purchased separately. The pushbutton panel has a protection index IP54 - protection index against mechanical impact IK10. The video indoor unit has 5" LCD display and Inductive Loop function (to enable use by people wearing hearing aids fitted with T selector). It has 2 physical keys for the control of the main functions - answer and end a call - and has 3 touch keys for the control of the main functions - door lock release, staircase light control and entrance panel activation/scrolling - there are further 4 configurable touch keys that perform different functions - e.g. intercom, additional door lock activation, generic activations.</p> <p>Wall mounted installation with the bracket supplied or table installation with support accessories (2 x 344692) - to be purchased separately.</p> <p>The device also has Professional Studio (Office) function and must be configured.</p>

Item	KIT COMPOSITION	Qty
343081	LINEA 3000 Entrance panel	1
344672	CLASSE 100V16E Video internal unit	1
346050	6 DIN System power supply	1
346250	Relay module accessory	1

PROFESSIONAL KITS

VILLA VIDEO KITS



364613



364622

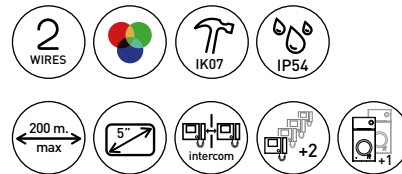

Pack	Item	CLASSE 100V16E - LINEA 2000 VIDEO KIT
1	364613	<p>One-family handsfree video kit consisting of: CLASSE 100V16E video indoor unit, LINEA 2000 pushbutton panel with colour camera and 1 call pushbutton.</p> <p>The push-button panel has a protection index against mechanical impact IK07 and protection index IP54.</p> <p>The video indoor unit has 2 physical keys for the control of the main video door entry functions – answer and end a call – and 3 touch keys that allow the door lock release, the entrance panel activation/scrolling and the customization of a most frequently used quick action – e.g. staircase light control, intercom, additional door lock activation, generic activations. The video indoor unit has a 5" colour LCD display and a side lever to adjust: colour, brightness and display contrast, audio and call tone volume. There is a call exclusion notification LED.</p> <p>Wall mounted installation with the bracket supplied or table installation with support accessories (2 x 344692) - to be purchased separately.</p>

Pack	Item	CLASSE 100V16B - LINEA 2000 VIDEO KIT
1	364622	<p>Two-families handsfree video kit consisting of: CLASSE 100V16B video indoor units, LINEA 2000 pushbutton panel with colour camera and 2 call pushbuttons. The push-button panel has a protection index against mechanical impact IK07 and protection index IP54.</p> <p>The video indoor units has 2 physical keys for the control of the main video door entry functions – answer and end a call – and 3 touch keys that allow the door lock release, the entrance panel activation/scrolling and the customization of a most frequently used quick action – e.g. staircase light control, intercom, additional door lock activation, generic activations. The video indoor units has a 5" colour LCD display and a side lever to adjust: colour, brightness and display contrast, audio and call tone volume. There is a call exclusion notification LED.</p> <p>Wall mounted installation with the bracket supplied or table installation with support accessories (2 x 344692) - to be purchased separately.</p>

Item	KIT COMPOSITION	Qty
343031	LINEA 2000 Entrance panel - 1 CALL	1
344652	CLASSE 100V16B Video internal unit	1
346050	6 DIN System power supply	1
346250	Relay module accessory	1

Item	KIT COMPOSITION	Qty
343032	LINEA 2000 Entrance panel - 2 CALLS	1
344652	CLASSE 100V16B Video internal unit	2
346050	6 DIN System power supply	1
346250	Relay module accessory	1



VILLA AUDIO KITS



364232



364231

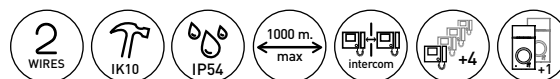
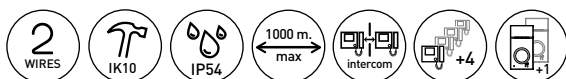

Pack	Item	CLASSE 100A16E - LINEA 3000 HANDS FREE AUDIO KIT
1	364232	One-family handsfree kit with CLASSE 100A16E audio indoor unit and LINEA 3000 pushbutton panel with zamak front cover. Can be configured for one-family or two-family installations. Nameplate lit by white LED. Can be wall or flush installed with specific accessories: (350020) flush mounted box with (343061) flush mounted accessory - to be purchased separately. Can be fitted with rainshield (343051) - to be purchased separately. The pushbutton panel has a protection index IP54 - protection index against mechanical impact IK10. The indoor unit has 2 physical keys for the control of the main door entry functions - answer and end a call - and has 3 touch keys for the control of the main functions - door lock release, staircase light control and entrance panel activation/scrolling - there are further 4 configurable touch keys that perform different functions - e.g. intercom, additional door lock activation, generic activations. Ringtone volume adjustment (with call exclusion) using the appropriate selector. The installation can be made to the wall using the bracket supplied or using table support accessory (1 x 344692) - to be purchased separately. The device also has Professional Studio (Office) function and must be configured.

Pack	Item	CLASSE 100A16M - LINEA 3000 AUDIO KIT WITH HAND SET
1	364231	One-family audio kit with CLASSE 100A16M audio indoor unit and LINEA 3000 pushbutton panel with zamak front cover. Can be configured for one-family or two-family installations. Nameplate lit by white LED. Can be wall or flush installed with specific accessories: (350020) flush mounted box with (343061) flush mounted accessory - to be purchased separately. Can be fitted with rainshield (343051) - to be purchased separately. The pushbutton panel has a protection index IP54 - protection index against mechanical impact IK10. The audio indoor unit has 3 touch keys for the control of the main functions - door lock release, staircase light control and entrance panel activation/scrolling - there are further 4 configurable touch keys that perform different functions - e.g. intercom, additional door lock activation, generic activations. Ringtone volume adjustment (with call exclusion) using the appropriate selector. The installation can be made to the wall using the bracket supplied or using table support accessory (1 x 344692) - to be purchased separately. The device also has Professional Studio (Office) function and must be configured.

Item	KIT COMPOSITION	Qty
343071	LINEA 3000 Audio entrance panel	1
344282	CLASSE 100A16E Audio internal unit	1
346040	6 DIN System power supply	1

Item	KIT COMPOSITION	Qty
343071	LINEA 3000 Audio entrance panel	1
344292	CLASSE 100A16M Audio internal unit	1
346040	6 DIN System power supply	1

PROFESSIONAL KITS

VILLA AUDIO KITS



366811

366821



Pack	Item	SPRINT L2 – LINEA 2000 AUDIO handset audio kit
		Audio kit with audio handset SPRINT L2 and LINEA 2000 pushbutton panel. 2 WIRE technology. The audio handset has a door lock release pushbutton and a pushbutton that can be configured for auxiliary functions (staircase light switching on, entrance panel activation, call to the switchboard). Devices suitable for wall mounted installation. Expandable with additional audio handset 344242.
1	366811	Complete one-family kit
1	366821	Complete two-family kit

Item	KIT COMPOSITION	366811	366821
		Qty	Qty
342911	LINEA 2000 Entrance panel - 1 CALL	1	-
342921	LINEA 2000 Entrance panel - 2 CALLS	-	1
344232	SPRINT L2 audio handset	1	2
346040	6 DIN System power supply	1	1



364211

Pack	Item	AUDIO HANDSFREE - LINEA 2000
1	364211	One-family expandable audio kit with audio handsfree internal unit and LINEA 2000 pushbutton panel. The audio internal unit can manage with (1 – 2) pushbuttons on board two independent contacts (24 Vac/dc – 1 A max.) Entrance panel and internal unit are suitable for wall mounted installation. Expansion possibility using the specific additional handsfree internal unit 331650

Item	KIT COMPOSITION	Qty
342911	LINEA 2000 Entrance panel - 1 CALL	1
331650	Audio handsfree internal unit	1
346040	6 DIN System power supply	1

ANALOGUE KITS

Audio Kits



363211



Pack	Item	SPRINT - LINEA 2000 AUDIO KIT handset audio kit
		Kit with SPRINT handset and LINEA 2000 pushbutton panel, aluminium finish. Devices suitable for wall mounted installation.
1	363211	Complete one-family kit
1	363221	Complete two-family kit

Item	KIT COMPOSITION	363211	363221
		Qty	Qty
-	LINEA 2000 Entrance panel - 1 CALL	1	-
-	LINEA 2000 Entrance panel - 2 CALLS	-	1
334202	SPRINT Audio handset	1	2
336000	6 DIN System power supply	1	1



363811



Pack	Item	SPRINT - LINEA 2000 AUDIO HANDSET KIT
1	363811	One-family kit with SPRINT handset and LINEA 2000 pushbutton panel. Analogue technology with 2 wire connection. Devices suitable for wall mounted installation. Expansion possibility using the specific additional handset 331550

Item	KIT COMPOSITION	Qty
-	LINEA 2000 Entrance panel	1
-	SPRINT audio handset	1
336842	2 DIN Transformer	1
ACCESSORIES		
331550	Specific additional audio handset	

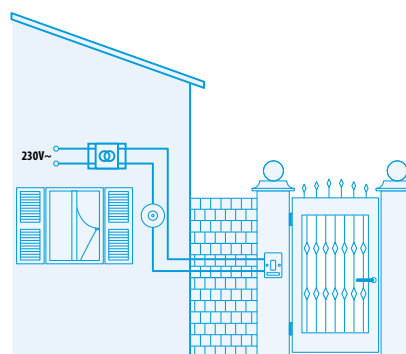

OLD BELL SYSTEM

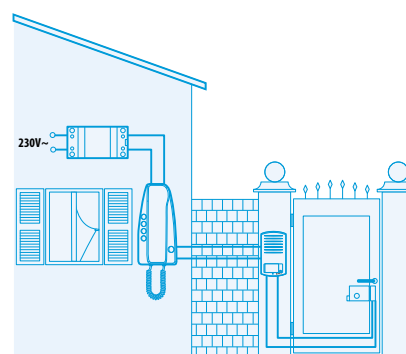

NEW AUDIO SYSTEM

2 wires system

The easiest system offer

The **2 WIRES SYSTEM** is the best technology for those cases when **TIME SAVING** and **EASE of INSTALLATION** are crucial. Thanks to the non polarized 2

wires system it is in fact possible to install, with the same ease, all kinds of systems, from those for single villas to those for apartment complexes.

This technology is particularly suitable, for example, for:

SMALL AND MEDIUM SIZE SYSTEMS



THE VILLA



THE APARTMENT

RENOVATIONS

The possibility of using existing cables makes it the ideal solution when refurbishing systems.



Remove the old entrance panel being replaced.

Use the two cables already present to connect the new entrance panel.





In addition to the extreme simplicity, the system offers **VERY GOOD PERFORMANCE**

SYSTEM MAIN FEATURES	
3900	Apartments
3900	Apartment video entrance panels
39	Risers with independent sound mode
5	Handsets per apartment
600 m	Distance between entrance panel and farthest internal unit

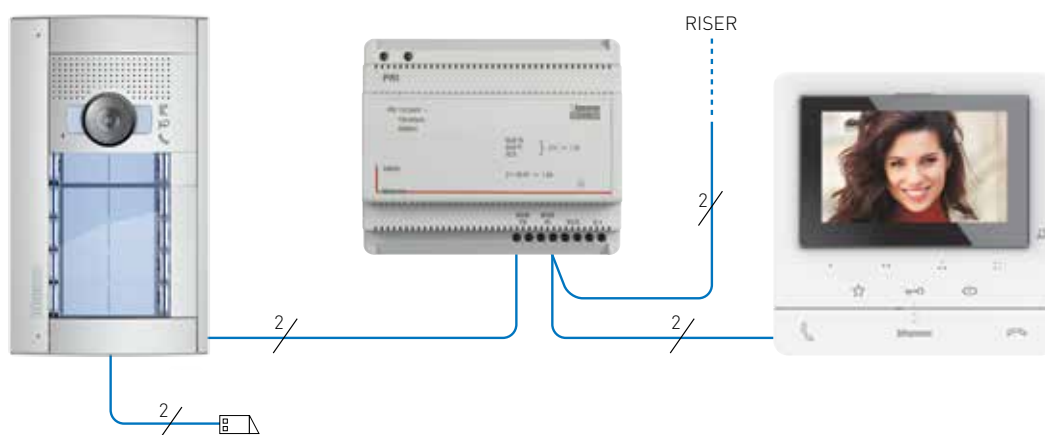

2 non-polarized wires for all the system



THE 2 WIRES SYSTEM

OFFERS A WIDE RANGE OF ENTRANCE PANELS AND INTERNAL UNITS, TO MEET ALL THE CUSTOMER NEEDS.

THE SYSTEM COMPOSITION



■ Thanks to the use of accessory devices, additional door locks can be activated and/or lights switched on.



■ In apartment-block systems the switchboard can be used for the management and centralised supervision of the apartment-block services.



■ In systems with Classe 300EOS / Classe 100X16E connected internal units, you can manage your door entry system calls and functions with your smartphone thanks to the dedicated Home + Security App and with you voice (C300EOS only).

A few accessory devices are needed to make the 2-WIRE systems, as well as the entrance panels and the internal units and/or video internal units.

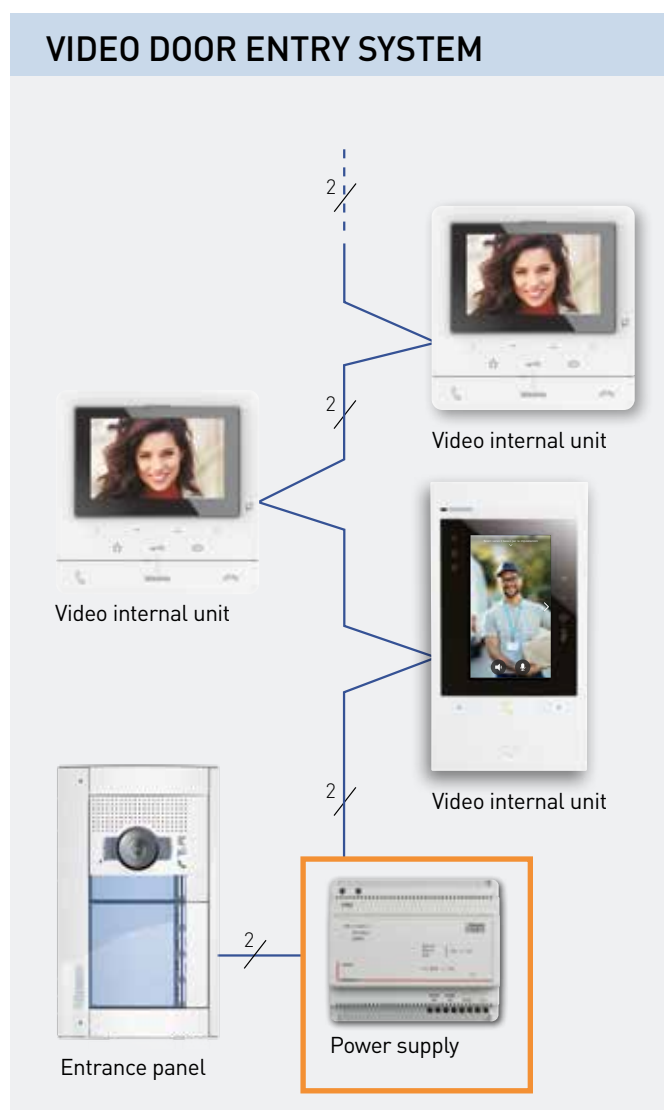
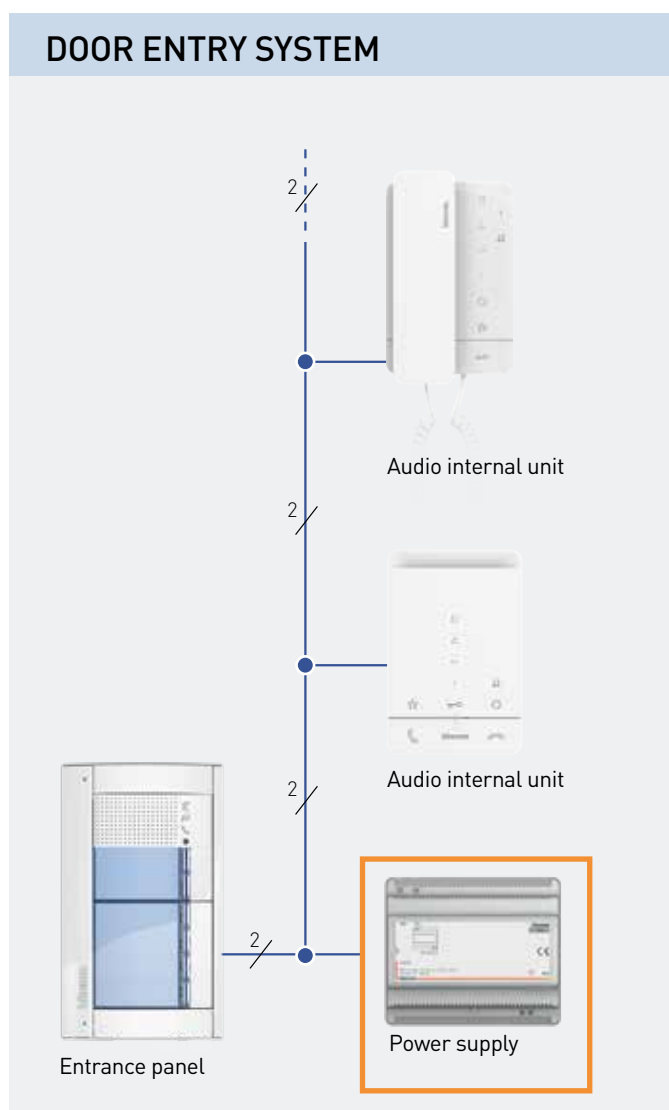

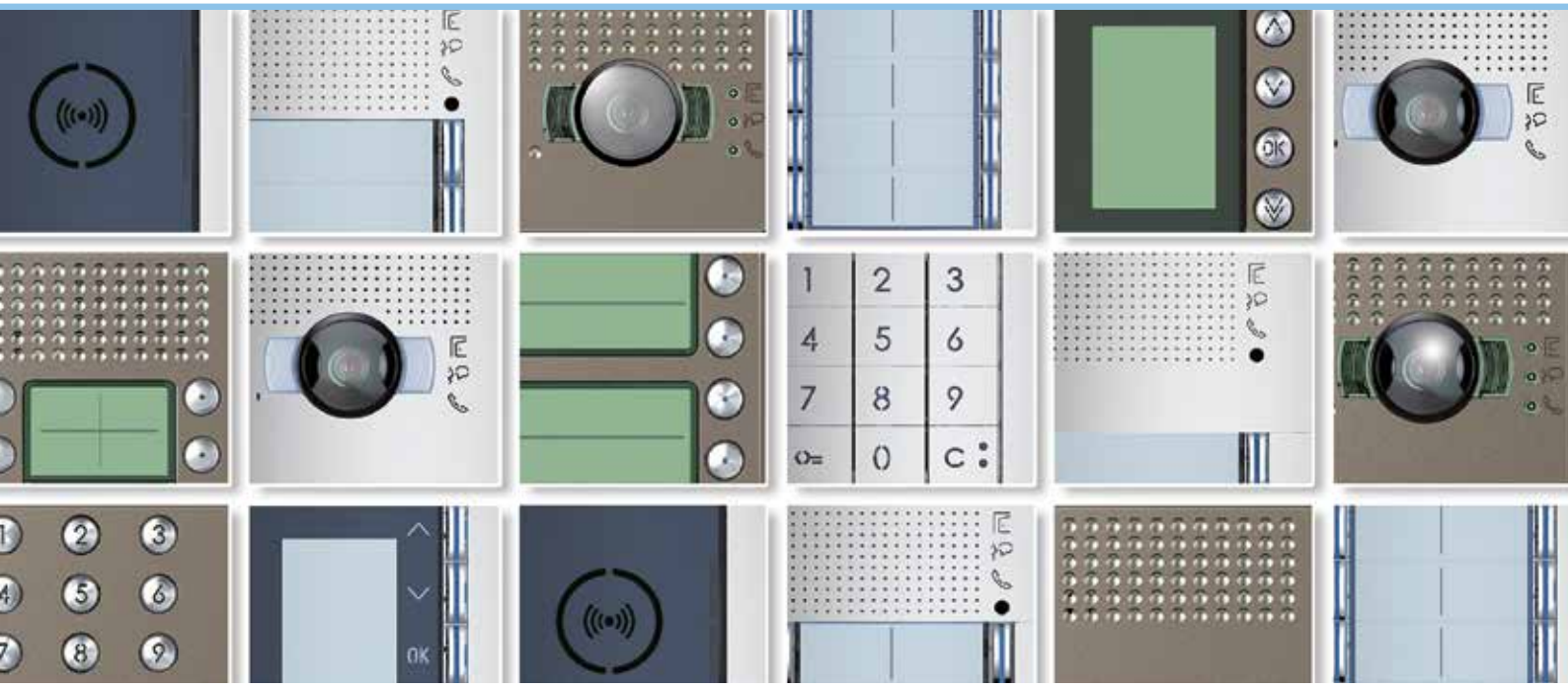

ENTRANCE panels range

LINEA SFERA

LINEA 3000

LINEA 2000

LINEA 100

LINEA 300



2 WIRES SYSTEM

ENTRANCE PANELS

Overview and features

	Linea Sfera New	Linea Sfera Robur	Linea 3000
			
Audio	●	●	●
Colour video	●	●	●
Finishes / Colours	Allmetal Allwhite Allstreet	Zamak Robur	Zamak grey Zamak black
Wall mounted installation	●	●	●
Flush mounted installation	●	●	●
Pushbutton call	●	●	●
Digital call	●	●	
Wide angle camera (1)	●	●	●
Night & Day camera (2)	●	●	
Control speech synthesis (3)	●	●	
Door lock release with keypad	●	●	
Door lock release with key card	●	●	●
Rainshield	●	●	●
Vandal proof			
Protection index	IP54	IP54	IP54
Sturdiness index	Up to IK08	IK10	IK10
Max. number of calls	100 with pushbuttons 4000 with digital call	100 with pushbuttons 4000 with digital call	2

(1) Horizontal and vertical wide viewing field. Easy to use for children and differently-abled people.

(2) Night lighting thanks to the IR LED with automatic IR filter. Sharp, perfect images even in limited light conditions.

(3) Inductive loop and control speech synthesis. Use by people wearing hearing aids. Easy to use for visually impaired people.



Linea 2000	Linea 300	Linea 100
		
●		●
●	●	
Aluminium	Stainless Steel Aluminium	Stainless Steel
●	●	●
	●	
●	●	●
		●
		●
		●
	●	
IP54	IP54	IP44
IK07	IK07	IK08
2 (up to 4 calls - audio version only)	32 with pushbuttons 4000 with digital call	8 with pushbuttons 4000 with digital call

2 WIRES SYSTEM
ENTRANCE PANEL
SFERA



SFERA NEW

SFERA ROBUR

TWO STYLES

ONE ELECTRONIC HEART

2-wires simplicity, maximum performance

Exceptional audio and video performance as well as fast and simple installation can be achieved with 2-wires technology

- Up to 4000 dwellings
- 20 handsets per dwelling
- Up to 96 video entrance panels
- Operable range of 600 m between entrance panel and internal unit

2 DESIGNS

SFERA NEW

A modern and sleek design suitable for residential and commercial developments.



Audio or video pushbutton entrance panel

Call from address book

SFERA ROBUR

Sturdy materials and optional flush-mounting boxes providing increased safety and preventing removal of the device



Audio or video pushbutton entrance panel

Digital call



12 FUNCTIONS

TRADITIONAL



Basic speaker module



Speaker module



Audio/video module



4 push-buttons module



8 push-buttons module



Nameplate module



Graphic display module

ADVANCED



Audio/video wide-angle camera module



Night/day wide-angle camera module



Inductive loop and control speech synthesis module

DOOR LOCK RELEASE



Keypad module



















Badge reader module

2 WIRES SYSTEM





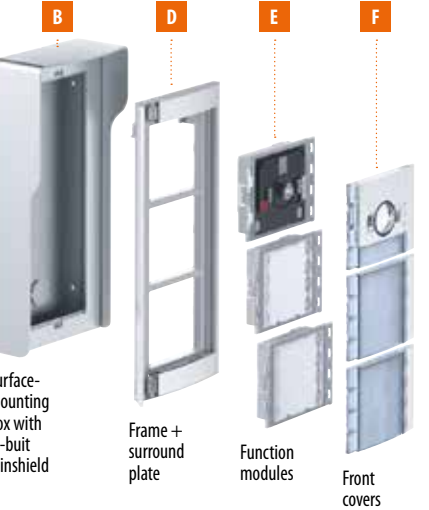







































SFERA NEW

Examples to select parts of the system

FINISHES	INSTALLATION TYPE	FLUSH-MOUNTING BOXES		RAINSHIELDS (OPTIONAL)		FRAMES/PLATES	
		Cat.Nos	Pack	Cat.Nos	Pack	Cat.Nos	Pack
Allmetal (silver)  1	FLUSH-MOUNTING INSTALLATION 	A  350010 1 module	1	C  35051.. 1 module	 35054.. 4 modules	 35021.. 1 module	1
		 350020 2 modules	1	 35052.. 2 modules	 35056.. 6 modules	 35022.. 2 modules	1
		 350030 3 modules	1	 35053.. 3 modules	 35059.. 9 modules	 35023.. 3 modules	1
Allwhite (white)  2	FLUSH-MOUNTING INSTALLATION 						
Allstreet (grey)  3	SURFACE-MOUNTING INSTALLATION 						

CHOOSE YOUR FINISH: Replace the dots in the Cat. No. with either 1, 2, or 3 to select the desired finish













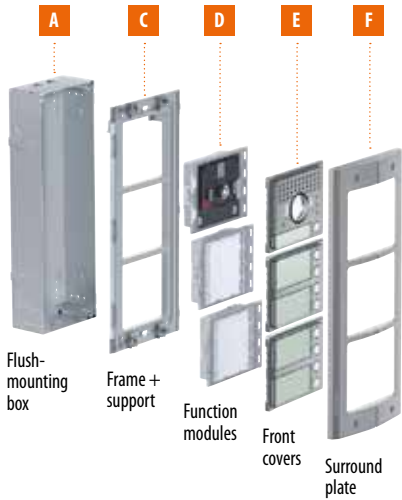









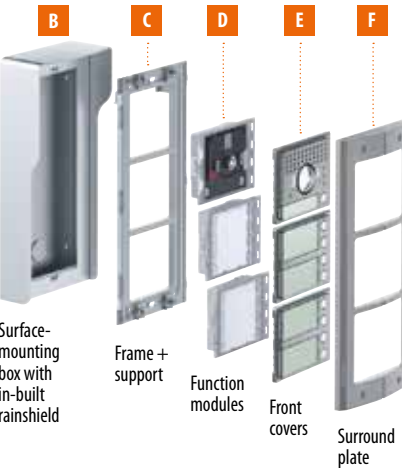

DIGITAL FUNCTION MODULES		FRONT COVERS					
Cat.Nos	Pack	Cat.Nos					Pack
E		F Audio front covers					
 351000 Basic speaker module (FOR AUDIO SYSTEMS ONLY)	1	 35100.. Basic speaker module	 35101.. Basic speaker module 1 push-button	 35102.. Basic speaker module 2 push-buttons	 35104.. Basic speaker module 2 push-buttons/double row	 35108.. Basic speaker module 4 push-buttons/double row	1
 351100 Speaker module	1	 35110.. Speaker module	 35111.. Speaker module 1 push-button	 35112.. Speaker module 2 push-buttons	 35114.. Speaker module 2 push-buttons/double row	 35118.. Speaker module 4 push-buttons/double row	1
 352000 4 push-buttons/ single row	1	 35203.. 3 push-buttons	 35204.. 4 push-buttons	 352011 1 push-button	 352021 2 push-buttons		1
 352100 8 push-buttons/ double row	1	 35216.. 6 push-buttons/double row	 35218.. 8 push-buttons/double row	 352121 2 push-buttons/double row	 352141 4 push-buttons/double row		1
E		F Video front covers					
 351200 Audio/video	1	 35120.. Audio/video	 35121.. Audio/video 1 push-button	 35122.. Audio/video 2 push-buttons/double row			1
 351300 Audio/video with wide angle camera	1	 35130.. Audio/video wide angle	 35131.. Audio/video wide angle 1 push-button	 35132.. Audio/video wide angle 2 push-buttons / double row		 354000 Cable for the connection or several push-button modules L= 470 mm	1
 352400 Night/day with wide angle camera	1	 35240.. Night/day with wide angle camera					1
E		F Miscellaneous front covers					
 352200 Name plate	1	 35220.. Name plate					1
 352500 Graphic display	1	 35250.. Graphic display					1
 352700 Inductive loop and control speech synthesis	1	 35270.. Inductive loop-speech synthesis				 35230.. Blanking reader	1
 353200 Badge reader	1	 35320.. Badge reader					1
 353000 Keypad	1	 35300.. Numeric keypad	 353011 Alphanumeric keypad				1

CHOOSE YOUR FINISH: Replace the dots in the Cat. No. with either 1, 2, or 3 to select the desired finish

2 WIRES SYSTEM



































SFERA ROBUR

Examples to select parts of the system

FINISHES	INSTALLATION TYPE	FLUSH-MOUNTING BOXES		SUPPORT FRAMES		FRAMES/PLATES	
	FLUSH-MOUNTING INSTALLATION	Cat.Nos	Pack	Cat.Nos	Pack	Cat.Nos	Pack
Vandal-resistant (ROBUR) 	 <p>Flush-mounting box</p> <p>Frame + support</p> <p>Function modules</p> <p>Front covers</p> <p>Surround plate</p>	<p>A</p>  <p>350110 1 module</p>  <p>350120 2 modules</p>  <p>350130 3 modules</p>	<p>1</p> <p>1</p> <p>1</p>	<p>C</p>  <p>350315 1 module</p>  <p>350325 2 modules</p>  <p>350335 3 modules</p>	<p>1</p> <p>1</p> <p>1</p>	<p>D</p>  <p>350415 1 module</p>  <p>350425 2 modules</p>  <p>350435 3 modules</p>	<p>1</p> <p>1</p> <p>1</p>
	INSTALLATION TYPE	SURFACE-MOUNTING BOXES		SUPPORT FRAMES		FRAMES/PLATES	
	SURFACE-MOUNTING INSTALLATION	Cat.Nos	Pack	Cat.Nos	Pack	Cat.Nos	Pack
	 <p>Surface-mounting box with in-built rainshield</p> <p>Frame + support</p> <p>Function modules</p> <p>Front covers</p> <p>Surround plate</p>	<p>B (*)</p>  <p>35061.. 1 module</p>  <p>35062.. 2 modules</p>  <p>35063.. 3 modules</p>  <p>35064.. 4 modules</p>  <p>35066.. 6 modules</p>  <p>35069.. 9 modules</p>	<p>1</p> <p>1</p> <p>1</p>	<p>C</p>  <p>350315 1 module</p>  <p>350325 2 modules</p>  <p>350335 3 modules</p>	<p>1</p> <p>1</p> <p>1</p>	<p>D</p>  <p>350415 1 module</p>  <p>350425 2 modules</p>  <p>350435 3 modules</p>	<p>1</p> <p>1</p> <p>1</p>

(*) CHOOSE YOUR FINISH: Replace the dots in the Cat. No. with either 1, 2, or 3 to select the desired finish - Refer to SFERA NEW finishes.



	DIGITAL FUNCTION MODULES		FRONT COVERS					
	Cat.Nos	Pack	Cat.Nos				Pack	
Speakers	E  351000 Basic speaker module (FOR AUDIO SYSTEMS ONLY)	1	F Audio front covers					
	 351100 Speaker module	1	 351005 Basic speaker module	 351015 Basic speaker module 1 push-button	 351025 Basic speaker module 2 push-buttons	 351045 Basic speaker module 2 push-buttons/double row	 351085 Basic speaker module 4 push-buttons/double row	1
Push-buttons	 352000 4 push-buttons/ single row	1	 352035 3 push-buttons	 352045 4 push-buttons				1
	 352100 8 push-buttons/ double row	1	 352165 6 push-buttons/double row	 352185 8 push-buttons/double row				
Cameras	 351200 Audio/video	1	 351205 Audio/video	 351215 Audio/video 1 push-button	 351225 Audio/video 2 push-buttons / double row			1
	 351300 Audio/video with wide angle camera	1	 351305 Audio/video wide angle	 351315 Audio/video wide angle 1 push-button	 351325 Audio/video wide angle 2 push-buttons / double row		 354000 Cable for the connection or several push-button modules L= 470 mm	1
	 352400 Night/day with wide angle camera	1	 352405 Night/day with wide angle camera					1
Miscellaneous	 352200 Name plate	1	 352205 Name plate					1
	 352500 Graphic display	1	 352505 Graphic display					1
	 352700 Inductive loop and control speech synthesis	1	 352705 Inductive loop-speech synthesis				 352305 Blanking reader	1
	 353200 Badge reader	1	 353205 Badge reader					1
	 353000 Keypad	1	 353005 Keypad					1

2 WIRES SYSTEM

SFERA

Electronic modules



351000



351100



351200



351300



352000



352100



352200

Pack	Item	Electronic modules
1	351000	Basic speaker module for the creation of 2 WIRE audio systems. Fitted with loudspeaker and microphone volume adjustment. It manages up to 100 pushbutton calls using additional double row pushbuttons. It can be used for opening an electrical door lock directly connected to the S+ and S- clamps (18 V 4 A impulsive - 250 mA holding current 30 Ohm max) and the connection to a local door lock release pushbutton on the PL clamps. To be completed with surround plate. The device must be physically configured.
1	351100	Speaker module for the creation of 2 WIRE audio & video systems. Fitted with loudspeaker and microphone volume adjustment. It can manage up to 100 pushbutton calls when using additional double row pushbutton modules. It can be used for opening an electrical door lock directly connected to the S+ and S- clamps (18 V 4 A impulsive - 250 mA holding current 30 Ohm max) and the connection to a local door lock release pushbutton on the PL clamps. Preset for additional power supply. Fitted with front LEDs for the notification of the operating status: door lock release, communication active, call put through, and system busy. Integrated optic sensor for the switching on of the night backlighting. To be completed with surround plate. The device can be configured either physically or using the PC and the TiSferaDesign software.
1	351200	Audio video module for the installation of 2 WIRE colour video systems. With Colour camera with 1/3" sensor and white LEDs for the lighting of the shooting field. Mist prevention heating resistance. Loudspeaker and Microphone volume adjustments. It can manage up to 98 pushbutton calls using the additional double row pushbutton modules. Horizontal and vertical camera position adjustment, +/- 10° in both directions. It offers the possibility of opening an electrical door lock directly connected to clamps S+ and S- (18 V 4 A impulsive - 250 mA holding current 30 Ohm max) and of connecting a local door lock release pushbutton on clamps PL. Preset for additional power supply. Fitted with front LEDs for the notification of the operating status: door lock release, communication active, call put through, and system busy. Integrated optic sensor for the switching on of the night backlighting. To be completed with surround plate. The device must be configured physically or using a PC and the TiSferaDesign software.

Pack	Item	Electronic modules
1	351300	Wide angle audio/video module for the installation of 2 WIRE colour video systems. With Colour camera with 1/3" sensor and white LEDs for the lighting of the shooting field. Mist prevention heating resistance. Loudspeaker and Microphone volume adjustments. It can manage up to 98 pushbutton calls using the additional double row pushbutton modules. It offers the possibility of opening an electrical door lock directly connected to clamps S+ and S- (18 V 4 A impulsive - 250 mA holding current 30 Ohm max) and of connecting a local door lock release pushbutton on clamps PL. Preset for additional power supply. Fitted with front LEDs for the notification of the operating status: door lock release, communication active, call put through, and system busy. Integrated optic sensor for the switching on of the night backlighting. To be completed with surround plate. The device must be configured physically or using a PC and the TiSferaDesign software
1	352000	Additional 4-pushbutton modules arranged on single column. To be used with speaker modules 351000 - 351100 and audio/video modules 351200 - 351300. Connection using the appropriate multicable supplied. Backlighting of nameplates controlled by the speaker module or the audio/video module connected. To be completed with surround plate
1	352100	Additional 8-pushbutton modules arranged on double column. To be used with speaker modules 351000 - 351100 and audio/video modules 351200 - 351300. Connection using the appropriate multicable supplied. Backlighting of nameplates controlled by the speaker module or the audio/video module connected. To be completed with surround plate
1	352200	Nameplate module normally used for displaying the house number or other notifications (e.g. Legend for calls using digital pushbutton panels, opening/closing times, etc.). Connection using the appropriate multicable supplied. Night backlighting controlled by the speaker module or the audio/video module connected. To be completed with surround plate

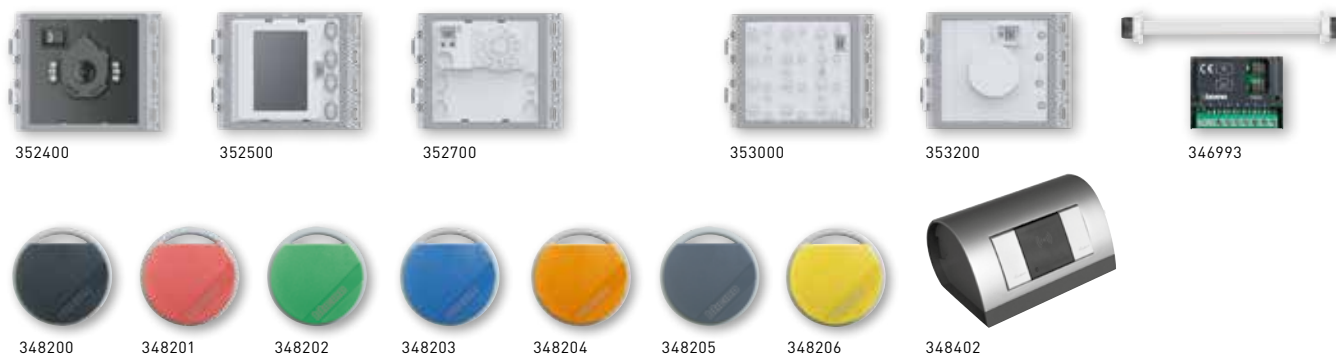

Pack	Item	Electronic modules
1	352400	Night & Day and wide angle camera module for the installation of colour video systems. Fitted with 1/3" sensor with N&D function and automatic removal of the IR filter. IR LED for the lighting of the field of view. Mist prevention heating resistance. Automatic brightness adjustment. Connection to the speaker module (351100) using the multicable supplied. To be completed with surround plate
1	352500	Graphic display module to be used with speaker module 351100 or with audio/video modules 351200 - 351300 (connection using the multicable supplied). It can operate in two modes: call from address book, or digital call. The call from the address book gives the possibility of sending the call by scrolling on the display the names associated to the residents. It is possible to store up to 4000 residents names. Using the keypad module item 353000 it is also possible to directly call the apartment by entering the number corresponding to the resident. The digital call is also performed using the keypad module item 353000 by entering the numerical code. It is recommended that one or more nameplate modules, item 352200, are installed at the side of the pushbutton panel to display the correspondence between the numerical codes and the names of the users. It is possible to program the names in the address book in two different ways: manual inclusion using the pushbuttons of the display module or inclusion using a PC with the TiSferaDesign software installed, by downloading the file to the display module (RECOMMENDED). System power supply cuts do NOT cause the loss of memory data. To be completed with surround plate
1	352700	Inductive loop and control speech synthesis module to be used with the 351100 speaker module or with audio/video modules 351200 - 351300. Enable use by people wearing hearing aids (fitted with T selector) or blind people thanks to the connection status voice message synthesis (call active, call ended, no answer, busy, door open). It is connected to the speaker module using the appropriate multicable supplied. To be completed with surround plate. The device can be configured either physically or using the PC and the TiSferaDesign software

Pack	Item	Electronic modules
1	353000	Keypad module for door lock release, or for the digital call of the apartment (to be used with the display module). It is fitted with relay with contacts (C - NC - NO) and clamps (CP- P1 - P2) for the connection of a local door lock release pushbutton. The numerical code for the opening of the door lock can be programmed using the keypad itself, or using a PC after downloading the module programming file. It also has a programming reset pushbutton and LEDs for the visual notification of the access status. Night backlighting with LEDs. To be completed with surround plate. It is connected to the other modules using the appropriate multicable supplied. The device may also be used as a stand alone unit with independent power supply and operation per la sola apertura serratura. Configuration performed using physical configurators, or a PC with the TiSferaDesign software installed
1	353200	RFID badge reader module for the release of the door lock by swiping the badge. It manages up to 20000 badges. It's fitted with relay contacts (C - NO - NC) and clamps (CP - P1 - P2) for the connection of a local door release pushbutton. The badge for the release of the door lock can be programmed from the module itself, or using a PC after downloading the module programming file. It also has a programming reset pushbutton and LEDs for the visual notification of the access status. Night backlighting a LEDs. To be completed with surround plate. It is connected to the other modules using the appropriate multicable supplied. The device may also be used as a stand alone unit with independent power supply and operation. Configuration performed using physical configurators, or a PC with the TiSferaDesign software installed
1	346993	Expander pushbutton module that gives the possibility of connecting call pushbuttons to the SFERA speaker modules (items 351000; 351100; 351200; 351300). Each module can manage up to 8 call pushbuttons. It is possible to connect several expander pushbutton modules (max 96 call pushbuttons for each Entrance Panel)
Transponder keys and programmer		
10	348200	Black transponder key
10	348201	Red transponder key
10	348202	Green transponder key
10	348203	Blue transponder key
10	348204	Orange transponder key
10	348205	Grey transponder key
10	348206	Yellow transponder key
1	348402	Table-top transponder key programmer

2 WIRES SYSTEM

LINEA 3000 entrance panel

ONE entrance panel for every NEED

LINEA 3000 can be configured both for 1 and 2 family house



ONE FAMILY HOUSE



- Write the name on the one family nameplate label (supplied with the product).
- Set the internal micro-switch on position 1.

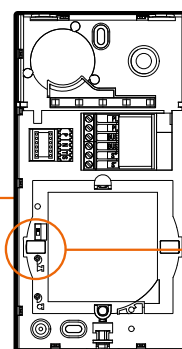
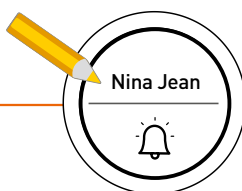

TWO FAMILY HOUSE



- Replace the nameplate label with the two family one (supplied with the product).
- Write the names on the two family nameplate label
- Set the internal micro-switch on position 2.

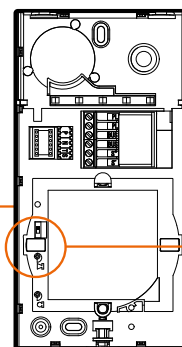
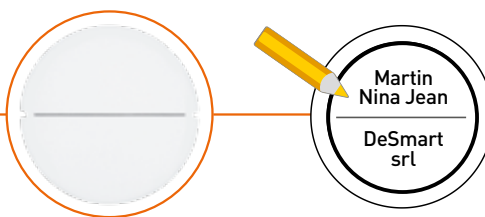

LINEA 3000 inside of the new professional kits

For **ONE FAMILY** house installation, you have to buy only the kit and all you need is inside it.

For **TWO FAMILY** house installation, you have to buy the kit + an additional 2 wires internal unit. (refer to 2 wires system internal units range).





HIGH installation flexibility

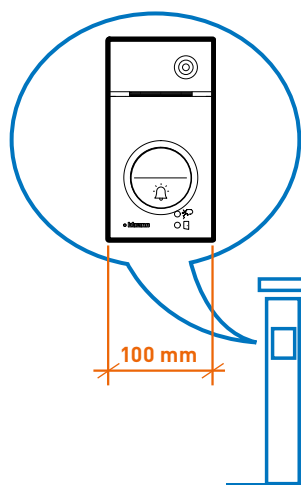

100 mm width
Suitable for **POLE INSTALLATION**



LINEA 3000 is sold for wall mounting installation but with the dedicated **ACCESSORIES** (to be purchased separately), you can use the entrance panel for **FLUSH MOUNTING INSTALLATION**.

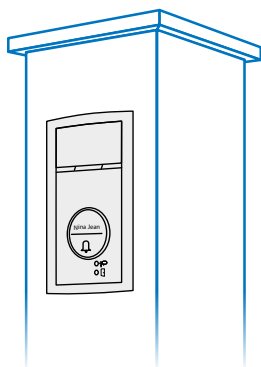

350020 +
343061 (grey version)
343063 (black version)



Also available in black version.

Ideal for renovations.....you can reuse the existing flush mounted box.
Same 2 Modules Tersystem and SFERA flush mounting box.

LINEA 3000 can be wall mounted with the dedicated **(343051) RAINSHIELD ACCESSORY** (to be purchased separately).

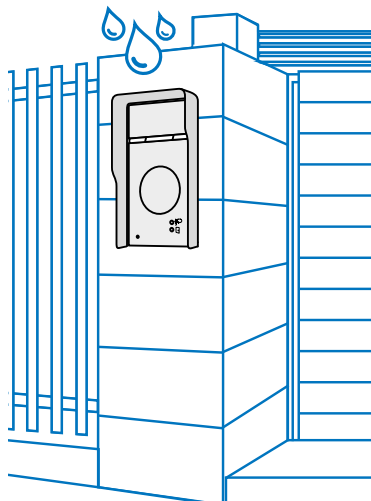

343051
(grey version)
343053
(black version)



Also available in black version.

2 WIRES SYSTEM

LINEA 3000 entrance panel

The entrance panels range dedicated to VILLA STANDARD

HIGH LEVEL APPLICATIONS



branded
quality

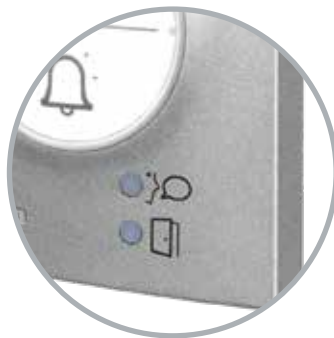

refined
detailing

Modern aesthetics
feeling of quality



floating
effect



hidden
technology



high relevance
on interaction

robustness
Zamak finishes



Weatherproof
(IP 54) protection degree



Robustness
(IK 10) protection degree



Unique DESIGN and robust PERCEPTION

Same look and ergonomics for all available versions:



343093



343091

LINEA 3000 video with door lock release badge



343081

LINEA 3000 video



343071

LINEA 3000 audio

Advanced FUNCTIONS

Wide angle camera

Horizontal and vertical wide viewing field. Easy to use for children and differently-abled People.



Door lock release

Door lock release with coloured badges or clear discs. Additional safe and comfort for all the residents.



2 WIRES SYSTEM

ENTRANCE PANEL

LINEA 3000



343091



343093



343081



343071



348260



348261

Pack	Item	LINEA 3000 Video entrance panel with door lock release proximity reader
1	343091	Wall mounted 2-Wires video pushbutton panel with Zamak front cover, wide angle colour camera and proximity reader. Fitted with white LED for the lighting of the shooting field in low light conditions. Can be set up for one or two family installation. It provides the possibility of opening an electrical door lock connected directly to clamps S+ and S- (18 V 4 A impulsive, 250 mA holding current, 30 ohm max). Can manage a maximum of 20 badges (125 KHz) for electrical door opening (master system badge included). White LED backlight name plate. Protection degree IP54 – protection against mechanical impact IK10. Supplied 1 set of door opening badges made up of : 6 coloured badges and 2 clear discs.
1	343093	Same as 343091 but in black finish

1	343081	LINEA 3000 Video entrance panel Wall mounted 2-Wires video pushbutton panel with Zamak front cover and wide angle colour camera.. Fitted with white LED for the lighting of the shooting field in low light conditions. Can be set up for one or two family installation. It provides the possibility of opening an electrical door lock connected directly to clamps S+ and S- (18 V 4 A impulsive, 250 mA holding current, 30 ohm max). White LED backlight name plate. Protection degree IP54 – protection against mechanical impact IK10.
---	--------	---

1	343071	LINEA 3000 Audio entrance panel Wall mounted 2-Wires pushbutton panel with Zamak front cover. Can be set up for one or two family installation. It provides the possibility of opening an electrical door lock connected directly to clamps S+ and S- (18 V 4 A impulsive, 250 mA holding current, 30 ohm max). White LED backlight name plate. Protection degree IP54 – protection against mechanical impact IK10.
---	--------	---

Pack	Item	LINEA 3000 Spare part front covers
1	343082	Spare part front cover for video entrance panels 343081 and 343091.
1	343072	Spare part front cover for audio entrance panel 343071.
1	348260	Door lock release badge and clear disc Set made up of 6 coloured badges which can be programmed to open the door
1	348261	Set made up of 2 programmable clear discs which can be programmed to open the door



Pack	Item	LINEA 3000 Rainshield accessory
1	343051	Rainshield roof accessory for Linea 3000 (343071 - 343081 - 343091) entrance panels. To be purchased separately.
1	343053	Rainshield roof accessory for Linea 3000 (343093) entrance panel. To be purchased separately.

Pack	Item	LINEA 3000 Flush mounting accessory + plastic box
1	343061	Flush mounting frame accessory for Linea 3000 (343071 - 343081 - 343091) entrance panels. To be purchased separately.
1	343063	Flush mounting frame accessory for Linea 3000 (343093) entrance panel. To be purchased separately.
1	350020	Plastic box suitable for the flush mounting installation of Linea 3000 entrance panels (343071 - 343081 - 343091 - 343093) together with the specific frame accessory 343061 - 343063. To be purchased separately.



2 WIRES SYSTEM ENTRANCE PANEL LINEA 2000



343031



343032



342911



342921



342931



342941

Pack	Item	Wall mounted colour video entrance panel
1	343031	2 WIRE video pushbutton panel with a call key and colour camera. Fitted with white LEDs for the lighting of the shooting field in low light conditions. Aluminium front cover. Nameplate lit by green LED
1	343032	As item 343031, but with 2 call pushbuttons

Pack	Item	Wall mounted audio entrance panel
1	342911	2 WIRE audio pushbutton panel with one call pushbutton for wall mounted installation. Aluminium front cover. Nameplate lit by green LED
1	342921	As item 342911, but with 2 call pushbuttons
1	342931	As item 342911, but with 3 call pushbuttons
1	342941	As item 342911, but with 4 call pushbuttons





LINEA 100



343101



343102



343100

Pack	Item	Pushbuttons audio entrance panel
1	343101	2 WIRE audio pushbutton panel with 4 call pushbuttons for wall mounted installation. It's fitted with rainshield and internal contact (C - NO - NC) for the connection of an electrical door lock or external actuator (for the power supply to the electrical door lock allow for the installation of auxiliary transformer item 336482). Connections (PL) for a local door lock release pushbutton
1	343102	2 WIRE audio pushbutton panel with 8 call pushbuttons for wall mounted installation. It's fitted with rainshield and internal contact (C - NO - NC) for the connection of an electrical door lock or external actuator (for the power supply to the electrical door lock allow for the installation of auxiliary transformer item 336482). Connections (PL) for a local door lock release pushbutton

Pack	Item	Digital call audio entrance panel
1	343100	2 WIRE AUDIO digital call pushbutton panel for wall mounted installation. The device consists of a pushbutton panel with 16 keys and a digital display showing the operating status. Using previously saved numerical (SCS addresses) or alphanumeric (logical addresses) codes, it is possible to call the internal units, and for the residents to release the door lock using a dedicated numerical code. The pushbutton panel manages up to 4000 internal unit addresses (from 0 to 3999), as well as the direct call to the 2 WIRE switchboard. It's fitted with rainshield and internal contact (C - NO - NC) for the connection of an electrical door lock or external actuator (for the power supply to the electrical door lock allow for the installation of auxiliary transformer item 336482). Connections (PL) for a local door lock release pushbutton



2 WIRES SYSTEM ENTRANCE PANEL LINEA 300



Pack	Item	Aluminium finish pushbutton panel
1	308001 308011	Monobloc vandal-resistant 2 WIRE video pushbutton panel for 2 and 4 calls with aluminium finish. The item code includes: flush mounted box, frame, colour video and audio electronic module, prewired pushbutton module/s. Presetting for the mounting of transponder reader or key switch. Backlit call keys. Visual and sound notifications of the communication status for: call active, system busy, door lock status
1	308002 308012	As item 308001 but for up to 8 calls
1	308003 308013	As item 308001 but for up to 12 calls
1	308004 308014	As item 308001 but for up to 20 calls
1	308005 308015	As item 308001 but for up to 32 calls

Pack	Item	Stainless steel finish pushbutton panel
1	308011	Monobloc vandal-resistant 2 WIRE video pushbutton panel for 2 and 4 calls with stainless steel finish. The item code includes: flush mounted box, frame, colour video and audio electronic module, prewired pushbutton module/s. Presetting for the mounting of transponder reader or key switch. Backlit call keys. Visual and sound notifications of the communication status for: call active, system busy, door lock status
1	308012	As item 308011 but for up to 8 calls
1	308013	As item 308011 but for up to 12 calls
1	308014	As item 308011 but for up to 20 calls
1	308015	As item 308011 but for up to 32 calls

Pack	Item	Wall mounted boxes
1	308021	Wall mounted box for pushbutton panels, items 308001-308011
1	308022	Wall mounted box for pushbutton panels, items 308002-308012
1	308023	Wall mounted box for pushbutton panels, items 308003-308013
1	308024	Wall mounted box for pushbutton panels, items 308004-308014
1	308025	Wall mounted box for pushbutton panels, items 308005-308015



308040



308026



Pack	Item	Digital call entrance panel
1	308040	Monobloc vandal-resistant 2 WIRE digital call video pushbutton panel (in stainless steel), flush mounted or wall mounted installation (with specific box item 308026 sold separately). The item includes: flush mounted vandal-resistant steel box, audio and video module with wide angle colour camera, integrated graphic display, and alphanumeric keypad for direct apartment call, fast address book search, and door lock release using a code. Presetting for the installation of a T25 Vigik reader, or a key switch. Backlit display and BLUE keys. It is possible to store up to 4000 residents names. Visual, sound, or control speech synthesis communication status notification, for example: call active, system busy, door lock status. Direct control of an electric door lock 18V-4A impulsive, 250 mA holding current (30 ohm max). System power supply cuts do NOT cause the loss of memory data. Selectable display menu languages are: Italian, English and French. The device can be configured physically or using a PC with the specific software, which can be downloaded free of charge from www.homesystems-legrandgroup.com
1	308026	Wall mounted box for digital call entrance panel 308040



CLASSE 300E0S



CLASSE 100 X16E



CLASSE 100 A16E





INTERNAL UNITS RANGE

CLASSE 300EOS

CLASSE 100

SPRINT L2

2 WIRES SYSTEM

INTERNAL UNITS

Overview and features

	Classe 300EOS with Netatmo	Classe 100X16E	Classe 100V16E
			
Audio			
Colour video	●	●	●
Handsfree	●	●	●
Call redirection on smartphone	●	●	
Integrated Alexa voice assistant	●		
Wifi connection	●	●	
Finishes / Colours	White	White	White
Display	LCD Touch 5"	LCD 5"	LCD 5"
Answering machine	●		
Floor call	●	●	●
Door lock release	●	●	●
Staircase light control	●	●	●
Scrolling EP activation	●	●	●
Intercom (1)	●	●	●
Inductive loop (2)	●	●	●
Professional studio function	●	●	●
Safe door lock function	●	●	●
Note / message function	●		
Quick link / Favourite	●		
Wall-mounted installation	●	●	●
Tabletop installation		●	●

(1) The intercom function allows for up to 3-minute communication between and among video door entry systems in the same apartment / in different apartments.

(2) Use by people wearing hearing aids fitted with (T) selector.

(3) Activated with specific configuration inserted in P.



Classe 100V16B	Classe 100V16M	Classe 100A16E	Classe 100A16M	Sprint L2
		•	•	•
•	•			
•		•		
White	White	White	White	White
LCD 5"	LCD 4,3"			
•	•	•	•	•
•	•	•	•	•
•	•	•	•	• (3)
•	•	•	•	• (3)
•	•	•	•	
		•	•	
•	•	•	•	
	•			
•	•	•	•	•
•		•	•	

2 WIRES SYSTEM
INTERNAL UNITS
CLASSE 300EOS with Netatmo

CLASSE 300EOS

THE EVOLUTION OF SMART



Video door
entry system



Management
with smartphone



Voice
control



Smart
Home



Smart
Security



Classe 300EOS with Netatmo is the new 2 wires / Wi-Fi handsfree connected video internal unit with built-in Amazon Alexa voice assistant. Using the Home + Security App, in addition to video door entry calls, it is also possible to manage the devices of the Netatmo security range, creating a simple and fast Smart security system.



CLASSE 300EOS | WITH Netatmo

Change your idea of a video internal unit.

2 WIRES SYSTEM
INTERNAL UNITS
CLASSE 300EOS with Netatmo

DESIGN



The smart vision of the home.

Distinctive design to meet the needs of contemporary living. Vertical and super slim. With its clean and modern design, it gives every type of home an innovative look, and offers a unique user experience.



Vertical display and curved shape:
a disruptive and modern design,
but also understated.



5" Touch Screen

Vertical display
for a better view
of the caller



Face detection

Automatic centring
of the subject
on the display



Horizontal display

Double "tap" the display
to view the image
in landscape format



Curved shape

The shape of a welcome:
a "welcoming effect"
for residents and guests.



2 WIRES SYSTEM
INTERNAL UNITS
CLASSE 300EOS with Netatmo

HOME + SECURITY

Always aware with the Home + Security App



Home + Security

The best App for a safe home

Alerts and notifications for incoming calls, motion and people detection, event information and door lock management with a simple and intuitive interface.



Answer the calls,
activate the electrical door locks,
activate the cameras and display
the timeline of the events

Manage up to 20 homes
with your single account



Home + Security

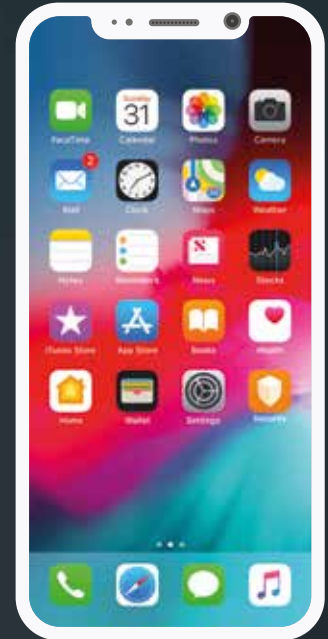

Incoming call
Receive notification
when someone
is calling

See who's calling
Answer the call and
open the gate for
the courier

Check the events
Check who called you
and if they left you
a message

Quick actions
- Activate the electrical door locks
- Activate the timed staircase lights
- Call home / Intercom
- Activate the cameras
- Manage the video door entry
answering machine

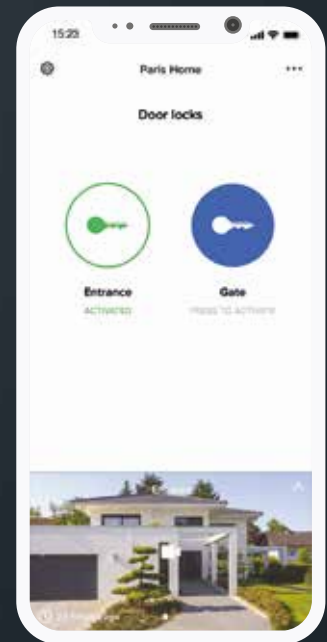
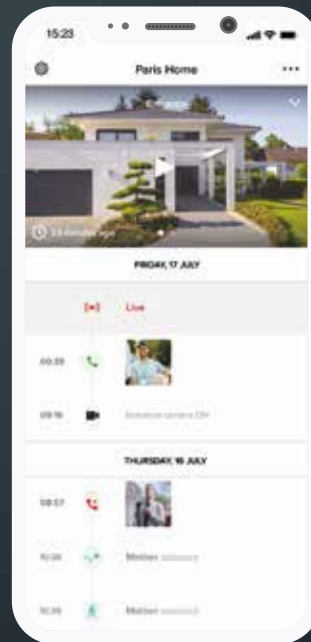
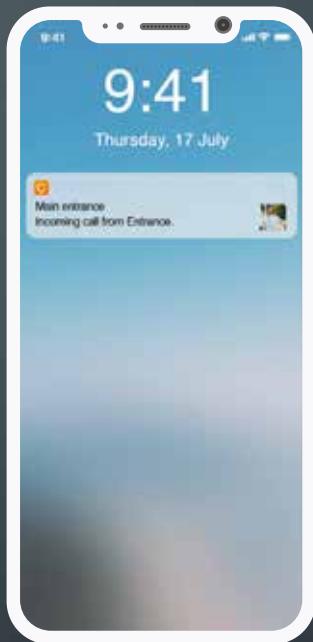

2 WIRES SYSTEM
INTERNAL UNITS
CLASSE 300EOS with Netatmo

SAFETY

Security enhancement with integration of Netatmo devices

Video door entry system and security. Together.

Video door entry system



Main entrance
Incoming entrance call.

Security



Secondary entrance and interiors
Smart Outdoor Camera with Siren and movement detection. Smart Indoor Camera with face recognition.

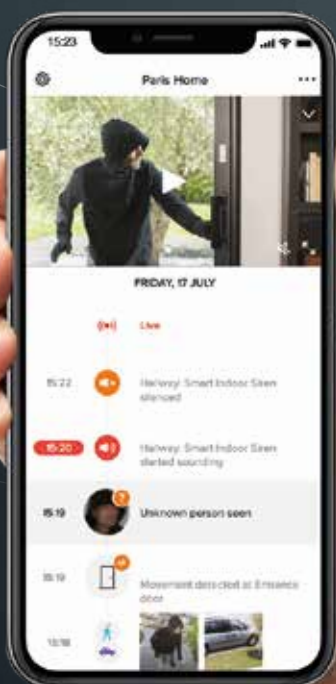

A single App with an intuitive home page. It allows you to answer video door entry calls, activate the door lock and view images from Netatmo smart outdoor and indoor cameras.



Professional opportunity: offer your services as an installer of simple smart security systems.
Business opportunities: access to a catalogue of smart and easy-to-install security devices.

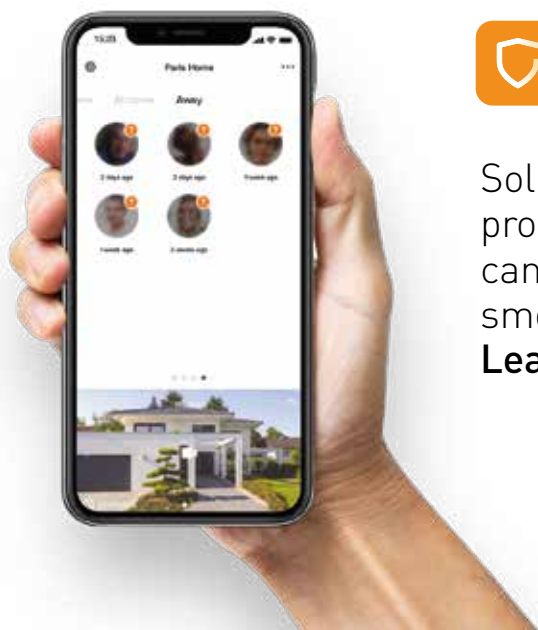

Home + Security
 The best App for a safe home.

Solutions for a smart and complete protection of your home: security cameras, alarms, opening sensors, smoke detector...

Leave your home without worries.

WITH
Netatmo

Netatmo solutions natively integrated in the Home + Security App



Smart Outdoor Camera



Smart Outdoor Camera with Siren



Smart Indoor Camera



Smart Door and Window Sensors



Smart Video Doorbell



Smart Indoor Siren



Smart Smoke Alarm



Smart Carbon Monoxide Alarm

2 WIRES SYSTEM
INTERNAL UNITS
CLASSE 300EOS with Netatmo

ALEXA BUILT-IN



The first video internal unit with built-in Alexa

Enjoy the full Alexa experience
interacting with all its functions, such as:
Custom routines - Play Music - Smart Home
To set the clock alarms - Memos and
video door entry functions.



Add any compatible “works with Alexa” devices, to offer your customers an increasingly Smart home.



“Alexa, open the gate”



“Alexa, answer the call”



“Alexa, I go out”

NOTE: Alexa is not available in all languages and Countries.
Alexa features and functionality may vary by location.

2 WIRES SYSTEM

INTERNAL UNITS

CLASSE 300EOS with Netatmo

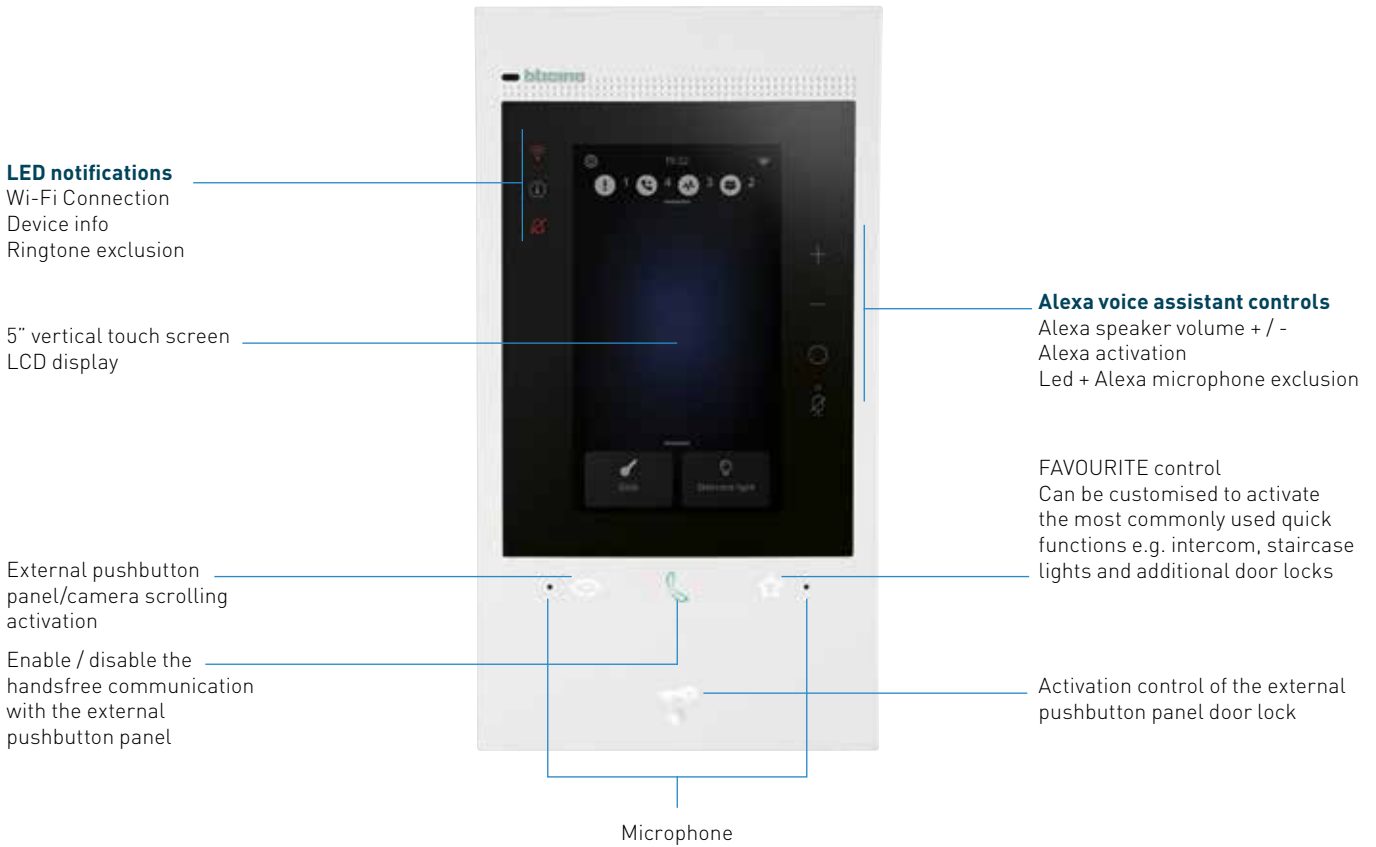

Back view

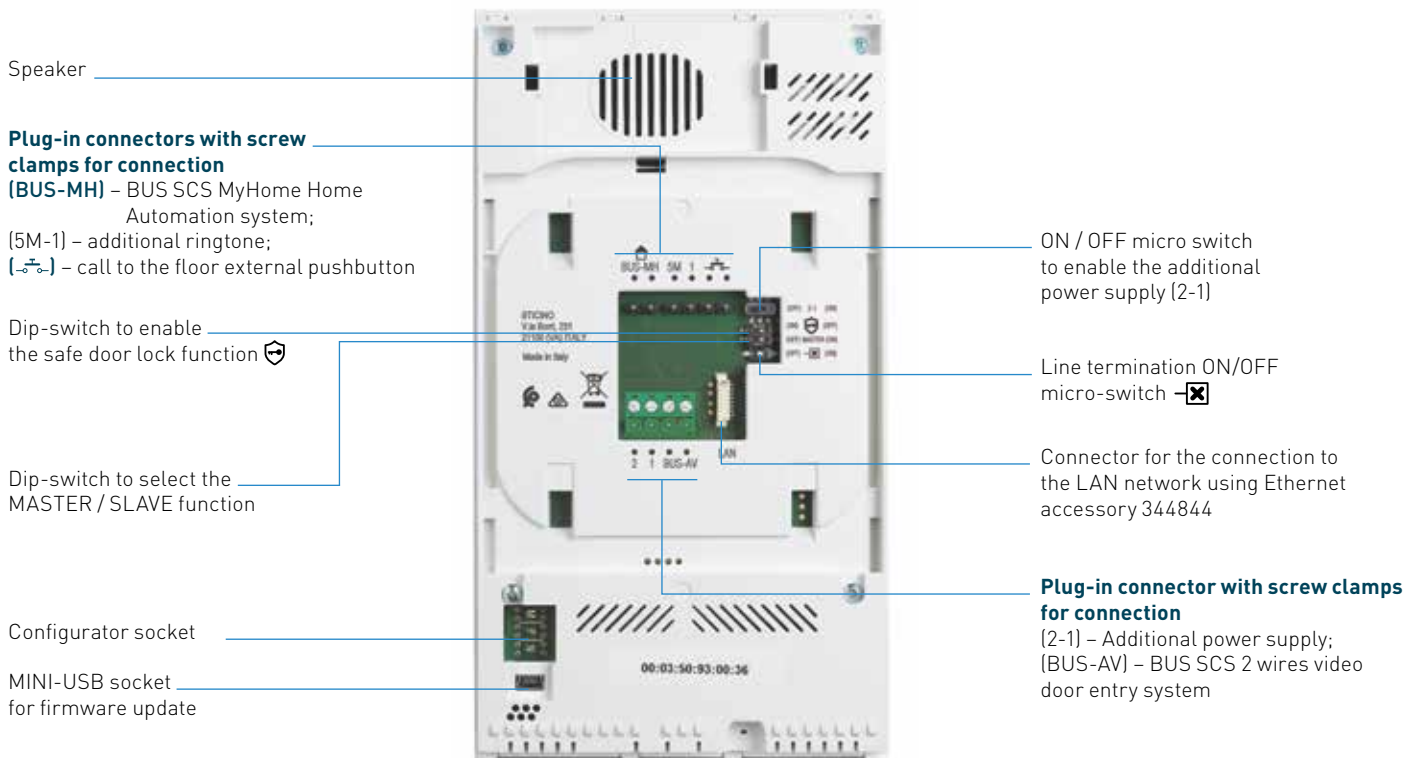



344842



344844



346020

Pack	Item	CLASSE 300EOS WITH NETATMO connected video internal unit
1	344842	<p>2 wires/Wi-Fi handsfree connected video internal unit with built-in Amazon Alexa voice assistant, 5" vertical touch screen LCD display and video door entry answering machine. It has a physical key for door lock release and capacitive keys for the control of the main video door entry functions: handsfree communication, entrance panel activation /camera scrolling and Favourite key (can be configured to activate the quick actions most frequently used – e.g. additional door locks, staircase light control, intercom). There are notification LEDs for: Wi-Fi network connection status, info / notifications and call exclusion.</p> <p>It is possible to easily interact with the built-in Alexa voice assistant, either using the dedicated capacitive keys or with your voice, and activate several functions, such as the video door entry functions, Smart Home, scenarios, reminders etc. Using the touch display, it is possible to access the notification list, as well as your favourite door entry, security and Smart Home controls (if any). Possibility of voice communication with the switchboard - if present in the system - after a specific call. The device must be configured by physically connecting the configurators, or using the menu, which will give better possibilities of customisation of associated functions and texts. Thanks to the Wi-Fi connection, you can associate the video internal unit to the Home + Security App (available for Android and iOS). The App allows to use the main video internal unit functions (receiving calls, door lock release, display of the event timeline and activation of the entrance panel/camera cycling). Through the Home + Security App, it is also possible to manage the products of the Netatmo security range (outdoor and indoor cameras, door and window sensors, indoor siren and smoke detector). This allows you to quickly and easily create a Smart security system. The device also allows to create and manage Smart Home functions, using the wired SCS BUS solution or the Zigbee solution, without the need for adding dedicated gateways. Wall mounted installation using the supplied bracket Possibility of Wi-Fi connection or using RJ45 ethernet cable with the dedicated accessory 344844.</p>

Pack	Item	Ethernet accessory
1	344844	Accessory cable for the wired connection of the Classe 300EOS video internal unit using an RJ45 Ethernet cable. To be purchased separately.
1	346020	2 DIN additional power supply Additional 2 DIN power supply to be used to supply the connected CLASSE 300EOS video internal unit (344842) locally, when required.



2 WIRES SYSTEM

NETATMO PRODUCTS

Smart Security devices

 Home + Security App



Pack	Item	Smart outdoor camera
1	NOC-PRO	Smart outdoor safety camera with detection of people, animals and vehicles. Aluminium single monobloc construction. Ultra-resistant glass and plastic, protection against UV rays. Video sensor: 4MP. Resolution: Full HD 1080 p. Coding: H.264. Long-range detection: up to 20 m. Field of view: 100°. 8x digital zoom for videos. Video live microphone. LED spotlight: 12 W, variable intensity. Infrared night vision: 15 m. Encryption protected access to the smartphone using the Home + Security App. Weather resistant: designed for outdoor use (HZO protection).
1	NOC-S-PRO	Smart outdoor camera with siren Smart outdoor safety camera with detection of people, animals and vehicles. Equipped with 105 db alarm siren. Aluminium single monobloc construction. Ultra-resistant glass and plastic, protection against UV rays. Video sensor: 4MP. Resolution: Full HD 1080 p. Coding: H.264. Long-range detection: up to 20 m. Field of view: 100°. 8x digital zoom for videos. Video live microphone. LED spotlight: 12 W, variable intensity. Infrared night vision: 15 m. Encryption protected access to the smartphone using the Home + Security App. Weather resistant: designed for outdoor use (HZO protection).

Pack	Item	Smart indoor camera
1	NSC-PRO	Smart indoor safety camera with people detection consisting of an aluminium monobloc unit. Video sensor: 4MP. 130° panoramic view for a wider coverage. High quality video with Full HD 1080 p viewing. Guaranteed day and night protection with infrared vision, for comfortable viewing even in total darkness. Recording only in case of intrusion, in respect of the privacy of the family. Encryption protected access to the smartphone using the Home + Security App. Declaration of conformity and FCC declarations. Open-source compatibility. It has to be connected to an electric socket with the supplied AC adapter.
1	NBU-AS-PRO	Smart video alarm system Smart video security alarm system consisting of 1 smart indoor camera, 1 smart indoor siren and 3 smart door and window opening sensors. The products can be easily configured and associated using the Home + Security app. The smart video alarm system activates and deactivates automatically, has pre-recorded sounds to simulate a presence in the home, respects the privacy of the family and activates a 110 dB sound in case of intrusion.
1	DTG-PRO	Smart door and window sensors Smart opening sensors for doors and windows ideal for safety. Sensors with waterproof monobloc construction, vibration/motion detection and open/closed status. Power supply with 2 AAA-type batteries included in the package. They only work with the smart indoor camera (sold separately): radio link between the sensors and the camera. Declaration of conformity and FCC. Open-source compatibility. Can be controlled and managed remotely with Home + Security app.



NDB - PRO



NSA - PRO - EU



NIS - 01 - PRO



NCO - PRO

Pack	Item	Smart video doorbell
1	NDB-PRO	Smart video doorbell for outdoor installation. Allows you to receive a video call on your smartphone when someone rings the doorbell. Equipped with Camera: 2 megapixels, 5x digital zoom. HDR function of automatic adaptation to lighting conditions. Infrared night vision even in conditions of total absence of brightness. Video: Full HD 1080 p, portrait format 9:16. Field of view: 140° diagonal. Sound: high-quality speaker and microphone. Night vision: Infrared LED. Operating temperature: -10° to 40° C. Weather resistant: H2O protection and IP44 certification. Power supply: 8-24 VAC & 230 VAC; minimum 8 VA. Local storage on microSD memory card and optional storage on Dropbox or FTP server. MicroSD card up to 32 GB (class 10). Data protection with encrypted connection for the highest level of privacy. Requirements: high speed internet access. The minimum required upload and download speed is 25 KB/s. Hotspots are not supported. Wireless specifications: Wi-Fi 802.11 b/g/n (2.4 GHz), Open/WEP/WPA/WPA2-personal. Operation via Home + Security app (iOS 10 required minimum - Android 5.0 required minimum). Compatible with Apple HomeKit, Google Assistant and Amazon Alexa. www
1	NSA-PRO-EU	Smart smoke alarm Smart Smoke Alarm with 85 dB alarm, high performance photoelectric sensor, average coverage 50 m ² . When it detects the presence of smoke, it activates its 85-decibel alarm and immediately alerts you to your smartphone. It is equipped with a 10-year battery - the maximum lifetime for all smoke detectors. The Self-Test feature checks if the Smart Smoke Alarm is functioning correctly. If it detects a problem, it sends a notification to your smartphone. Reliability guaranteed by CE (EN 14604) and NF certifications. Standalone device, no hub required. Compatible with Apple HomeKit. Operation via the Home + Security app. Requirements: High-speed wireless internet connection needed. Public hotspots not supported. The Smart Smoke Alarm will detect smoke and will sound even if the Wi-Fi isn't configured. However, you will need Wi-Fi to receive smartphone alerts. Wi-Fi 802.11 b/g/n (2.4 GHz), Open/WEP/WPA/WPA2-Personal, Bluetooth Low Energy (BLE).

Pack	Item	Smart indoor siren
1	NIS-01-PRO	Smart indoor siren with 110 dB alarm, pre-recorded sounds and vibration sensor for tamper detection. Battery power supply or with a cable (not supplied) using the USB micro port. It only works with the smart indoor camera and must be installed in the same room: Bluetooth Low Energy (BLE) wireless connection with the smart indoor camera. Declaration of conformity and FCC declarations. Open-source compatibility. Operation using the Home + Security app.
1	NCO-PRO	Smart carbon monoxide alarm Smart carbon monoxide alarm / detector for wall installation. It allows to monitor the fuel-burning appliances (boiler, fireplace, wood-burning stove, gas cooker, etc.) by measuring, in real time, the levels of carbon monoxide, which is an invisible, odourless and potentially fatal gas. When it detects the presence of carbon monoxide, it activates its 85-decibel alarm and immediately alerts you to your smartphone. It is equipped with a 10-year battery - the maximum lifetime for all carbon monoxide detectors. The Self-Test feature checks if the Smart Carbon Monoxide Alarm is functioning correctly. If it detects a problem, it sends a notification to your smartphone. Reliability guaranteed by CE (EN 50291) and NF certifications. Standalone device, no hub required. Compatible with Apple HomeKit. Operation via the Home + Security app. Requirements: High-speed wireless internet connection needed. Public hotspots not supported. The Smart Carbon Monoxide Alarm will detect Carbon Monoxide and will sound even if the Wi-Fi isn't configured. However, you will need Wi-Fi to receive smartphone alerts. Wi-Fi 802.11 b/g/n (2.4 GHz), Open/WEP/WPA/WPA2-Personal, Bluetooth Low Energy (BLE).

2 WIRES SYSTEM
INTERNAL UNITS
CLASSE 100



Now the standard is connected

The range of Classe 100 indoor units introduces the Wi-Fi connectivity in the standard video door entry system offer. The result is a range of video and audio indoor units with a modern and elegant design, capable of meeting all installation needs.



Built-in connectivity for constant connection with the home.

22
apt

Up to **22 apartments** without dedicated power supply.

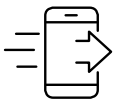

Immediate association with the Door Entry CLASSE 100X App.



Ideal for the refurbishment of old door entry systems.



No extra work for the installer; easier to use for the end user.



After being connected to Classe 100X, the smartphone becomes an “additional virtual video indoor unit” that can be used to answer calls, activate the opening of the door locks and activate the system cameras.



2 WIRES SYSTEM
INTERNAL UNITS
CLASSE 100

Door Entry App Classe 100X

Conceived for easy daily use





ATTENTION:

in the course of 2022, the Door Entry Classe 100X App will migrate to the new Home + Security App.

HOME PAGE SCREEN

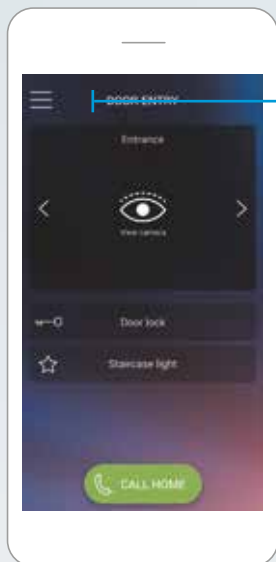

- App settings
- Camera display
- Door lock management
- Call home directly

CAMERA ACTIVATION SCREEN

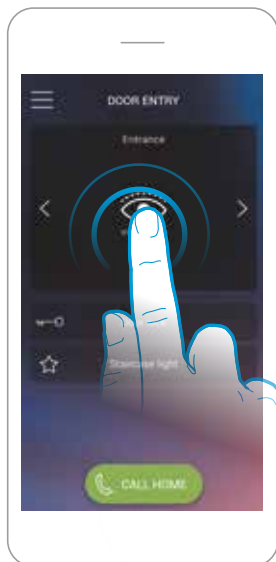

A simple touch for the end user

DOOR ENTRY is the App which allows, using the smartphone, to manage the video indoor unit calls locally and remotely or with a simple touch.

- open the gate,
- activate cameras,
- switch on the timed lights in the garden.



Select the camera and press to activate it

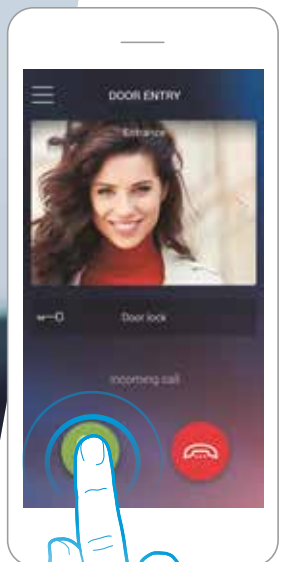

Answering the indoor unit is as easy as answering a normal telephone call

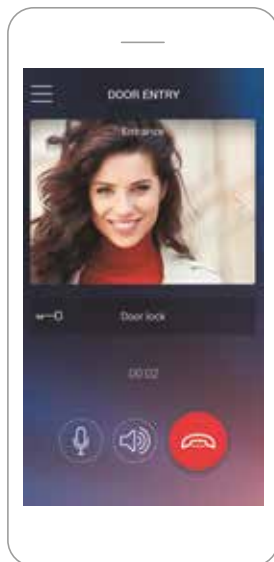

Call in progress

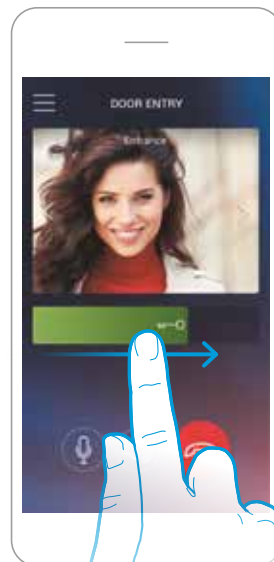

To open the door slide the key to the right – you will avoid opening the door accidentally

2 WIRES SYSTEM

INTERNAL UNITS

CLASSE 100

Features and functions

	Classe 100 X16E	Classe 100 V16E	Classe 100 V16B	Classe 100 V16M	Classe 100 A16E	Classe 100 A16M
						
	344682	344672	344652	344625	344282	344292

FEATURES						
LCD colour display	5 inches	5 inches	5 inches	4.3 inches		
Handsfree	●	●	●		●	
Finish	white	white	white	white	white	white
Available in KIT	364614	364612	364613		364232	364231
Installation	wall / table	wall / table	wall / table	wall	wall / table	wall / table

AVAILABLE FUNCTIONS FROM AUDIO / VIDEO INDOOR UNIT						
Door lock activation	●	●	●	●	●	●
Staircase light activation	●	●	●	●	●	●
EP / Scrolling activation	●	●	●	●	●	●
Intercom (1)	●	●	●	●	●	●
Inductive loop (2)	●	●				
Floor call	●	●	●	●	●	●
No. of configurable keys	4	4	1	1	4	4
No. of available ringtones	20	16	16	16	16	16
Professional Studio (Office)	●	●			●	●
Wi-Fi connectivity	●					





AVAILABLE FUNCTIONS FROM DOOR ENTRY APP						
Answer video door entry system calls	●					
Door lock activation	●					
Staircase light activation	●					
Intercom call from smartphone to video indoor unit	●					
Netatmo Smart cameras interoperability	●					
EP / Scrolling activation	●					

1) Audio call, max. 3 minutes, between indoor units of the same apartment/different apartments
 2) Use by people wearing hearing aids fitted with T selector



Front view

Touch sensitive controls



-  Door lock activation
-  Entrance panel/camera scrolling activation
-  Staircase light activation
-  Customisable controls for the activation of accessory functions (e.g. intercom, activation of additional door lock, various activations)

Physical control

Enable the handsfree communication



LED notifications

-  Wi-Fi Connection
-  Ringtone exclusion

Physical control

Disable the handsfree communication

Tactile guide

Rear view

Plug-in connectors with screw clamps for connections

Adjustment and programming menu access and navigation joystick

Line termination ON/OFF micro-switch

ON / OFF micro switch to enable the additional power supply

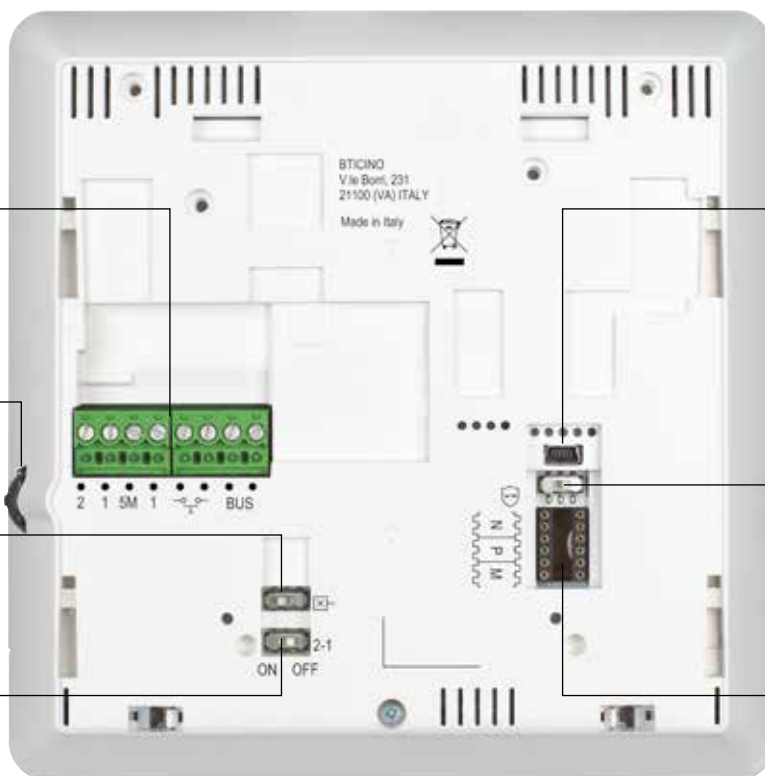

USB mini socket for firmware update

ON / OFF micro switch to enable the Safe Door Lock function

Configurator socket

2 WIRES SYSTEM

INTERNAL UNITS

CLASSE 100



344682



344672



344652



344625



Door Entry
CLASSE 100X App
See note (*)

Pack	Item	CLASSE 100X16E connected video indoor unit
1	344682	<p>2 WIRES/Wi-Fi handsfree connected video indoor unit with inductive loop and 5" colour LCD display. It has 2 physical keys for the control of the main video door entry functions – answer and end a call – it has 3 touch keys for the control of the main functions – door lock release, staircase light control and entrance panel activation/scrolling – there are further 4 configurable touch keys that perform different functions – e.g. intercom, additional door lock activation, generic activations. The device has a side lever to adjust: colour, brightness and display contrast, audio volume, call tone volume and Wi-Fi configuration. There are call exclusion notification LEDs and Wi-Fi. Also, thanks to the Wi-Fi connection, you can associate the video indoor unit to the Door Entry App (available for Android and iOS). You can manage the main video indoor unit functions (receiving calls, opening the door lock, activating the entrance panel/scrolling, firmware updating and additional activations) from the App. Netatmo Smart Outdoor & Smart Indoor cameras interoperability. The installation can be made to the wall using the bracket (supplied) or using table support accessories (2 x 344692) – to be purchased separately. The device also has Professional Studio (Office) function and must be configured.</p>
1	344672	<p>2 WIRES handsfree video indoor unit, with inductive loop and 5" colour LCD display. It has 2 physical keys for the control of the main video door entry functions – answer and end a call – it has 3 touch keys for the control of the main functions – door lock release, staircase light control and entrance panel activation/scrolling – there are further 4 configurable touch keys that perform different functions – e.g. intercom, additional door lock activation, generic activations. The video indoor unit has a side lever to adjust: colour, brightness and display contrast, audio and call tone volume. There is a call exclusion notification LED. The installation can be made to the wall using the bracket (supplied) or using table support accessories (2 x 344692) – to be purchased separately. The device also has Professional Studio (Office) function and must be configured.</p>

Pack	Item	CLASSE 100V16B video indoor unit
1	344652	<p>2 WIRES handsfree video indoor unit with 5" colour LCD display. The device has 2 physical keys for the control of the main video door entry functions – answer and end a call – and 3 touch keys that allow the door lock release, the entrance panel activation/scrolling and the customisation of a most frequently used quick action – e.g. staircase light control, intercom, additional door lock activation, generic activations. The device has a side lever to adjust: colour, brightness and display contrast, audio and call tone volume. There is a call exclusion notification LED. The installation can be made to the wall using the bracket (supplied) or using table support accessories (2 x 344692) – to be purchased separately. The device must be configured.</p>
1	344625	<p>2 WIRES video indoor unit with handset and 4.3" colour LCD display, suitable for wall mounting installation (bracket support included). The device has three touch keys that allows: door lock release, entrance panel camera activation/scrolling and customization of an auxiliary function – e.g. additional door lock activation, additional camera activation. Side easily accessible and independent regulations for: call volume / ringtone exclusion (with notification LED), display colour and brightness. The handset has magnets for easy holding.</p>

NOTE (*):
in the course of 2022, the Door Entry Classe 100X App will migrate to the new Home + Security App.



344282



344292



344692



336803



336982



346020

Pack	Item	CLASSE 100A16E HANDSFREE audio indoor unit
1	344282	2 WIRES handsfree audio indoor unit for wall mounted or table installation. It has 2 physical keys for the control of the main functions – answer and end a call – and has 3 touch keys for the control of the main functions – door lock release, staircase light control and entrance panel activation/scrolling – there are further 4 configurable touch keys that perform different functions – e.g. intercom, additional door lock activation, generic activations. The device has a side lever to adjust the audio volume and call tone and a call exclusion notification LED. The installation can be made to the wall using the bracket (supplied) or using table support accessory (1 x 344692) – to be purchased separately. The device also has Professional Studio (Office) function and must be configured.

1	344292	CLASSE 100A16M audio indoor unit with handset 2 WIRES audio indoor unit with handset for wall mounted or table installation. It has 3 touch keys for the control of the main functions – door lock release, staircase light control and entrance panel activation/scrolling – there are further 4 configurable touch keys that perform different functions – e.g. intercom, additional door lock activation, generic activations. Ringtone volume adjustment (with call exclusion) using the appropriate selector. The installation can be made to the wall using the bracket (supplied) or using table support accessory (1 x 344692) – to be purchased separately. The device also has Professional Studio (Office) function and must be configured.
---	--------	--

Pack	Item	Accessories - table support - cable - sockets
1	344692	Table support accessory for CLASSE 100 audio and video indoor units.
1	336803	8-way cable with connector for tabletop support connection.
1	336982	White Livinglight series 8-pole plug for the connection of the 336803 cable in tabletop installations. The socket is available also in the following finishings: - LIVINGLIGHT (336983 - 336984); - AXOLUTE (349414 - 349415 - 349418); - MATIX (336985).
1	346020	2 DIN additional power supply Additional 2 DIN power supply to be used for the local power supply to connected CLASSE 100x16E (344682) video indoor units in multi-family systems in complexes with more than 22 apartments.

2 WIRES SYSTEM INTERNAL UNITS CLASSE 100



344242



344232

Pack	Item	SPRINT L2 audio handsets
1	344242	2 WIRE audio handset (without the possibility of fitting with accessories) for audio systems and mixed audio /video systems. Wall mounted installation without the need of accessories. With door lock release key and auxiliary functions key (that can be configured). Ringtone volume adjustable on 3 levels. White
1	344232	As item 344242 but with call to the floor function

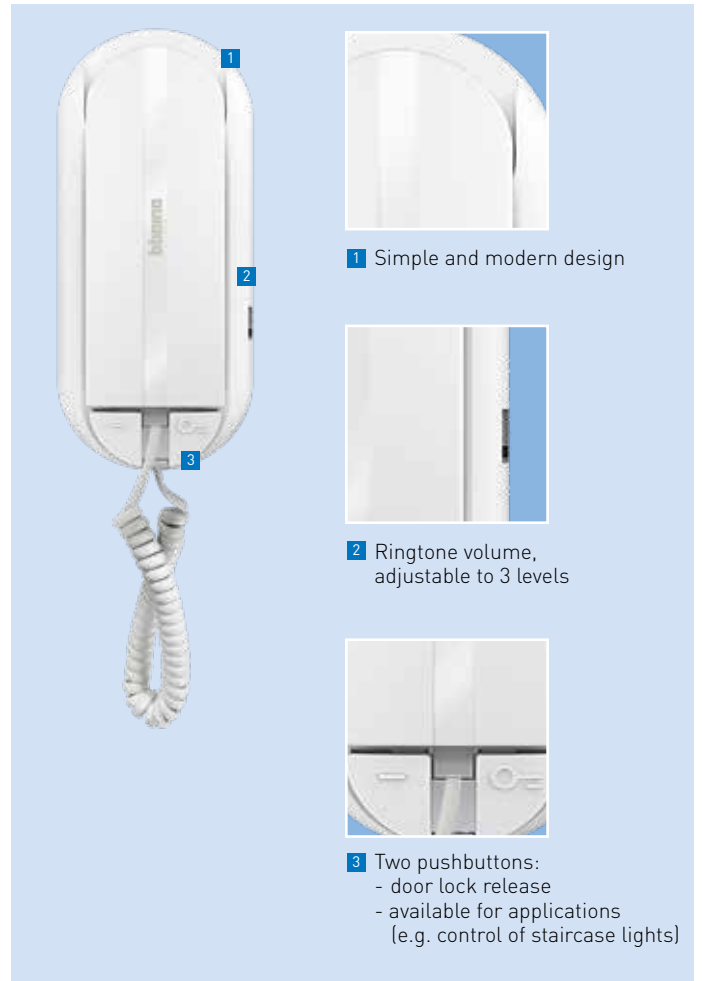

DIMENSIONAL DATA

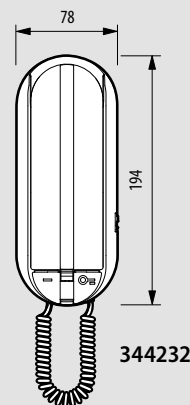

Size in mm



Porter switchboards



346310



346300

Pack	Item	Switchboard and accessories
1	346310	Switchboard for 2 WIRE audio and video systems. Allows access to various services (video door entry functions, door lock/ staircase light management and apartment alarm monitoring) directly from the keypad or via the intuitive icon menu. The switchboard is supplied with an integrated table supporting frame and also features a 7" colour LCD display, receiver and speaker phone, dedicated keys for the main functions and keys which can be configured. The programming can be carried out directly from the device or via PC with TiSwitchBoardDevice software (supplied). The device can manage the phonics of the riser EP (i.e. wired downstream of interface 346851); it cannot however manage the apartment EP (i.e. wired downstream of interface 346850). The use of an additional power supply is recommended. It is possible to connect up to a max. of 16 switchboards (configured from 0 to 15). WARNING: the switchboard cannot be used in systems with 2 WIRE-IP interface 346890. The new HIERARCHICAL mode is available only with the entrance panels of the following series: Sfera New, Linea 100, Minisfera, Linea 300.
1	336982	White 8-way socket for table top installation of switchboard item 346310
1	336803	8 - Way cable with connector for the table top installation connection.

Pack	Item	SOFTSWITCHBOARD software
1	346300	Switchboard software for the management of audio and video door entry system calls. The software (Windows operating system compatible) can be installed on any desktop or laptop PC, and gives the possibility of receiving, managing and transferring the calls from the entrance panel and the handset. It implements home video monitoring, with cyclical display of the cameras, night and day functions, and the possibility of displaying the alarms in the various apartments. - Supported operating systems: Microsoft Windows XP Service Pack 2, Windows Vista and Windows 7. - Software required: NET Framework 3.5 or higher

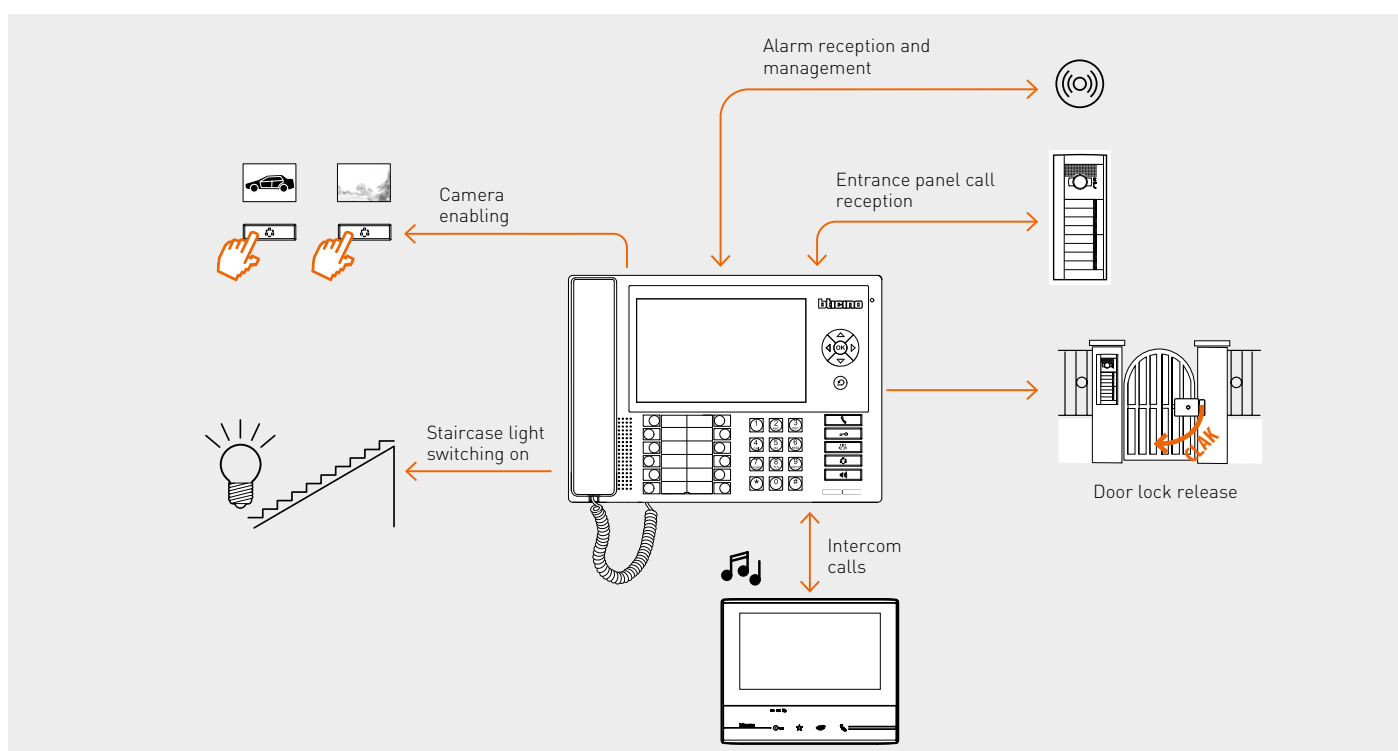

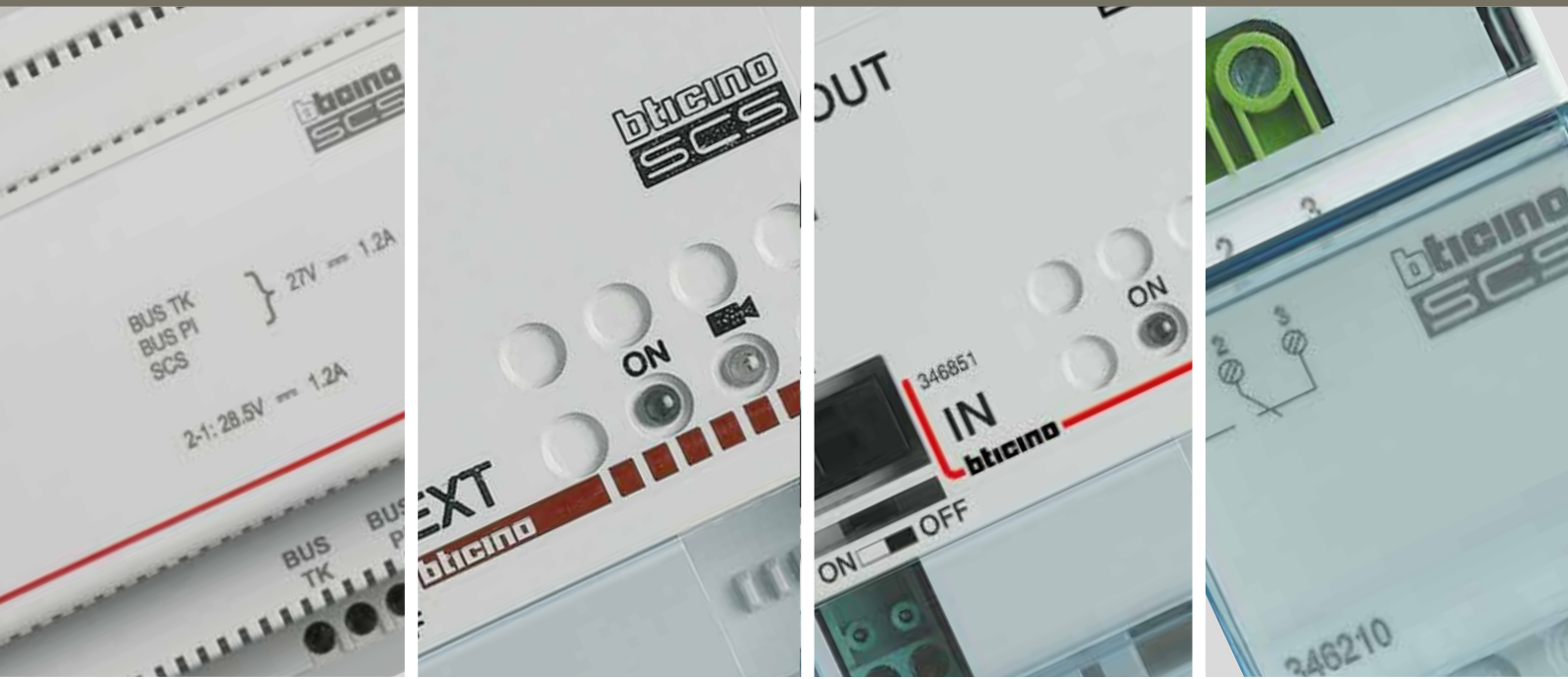

SYSTEM accessories Range

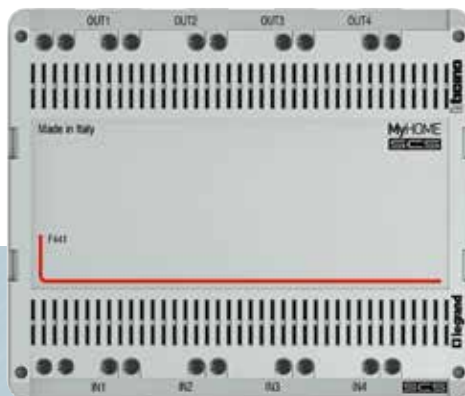
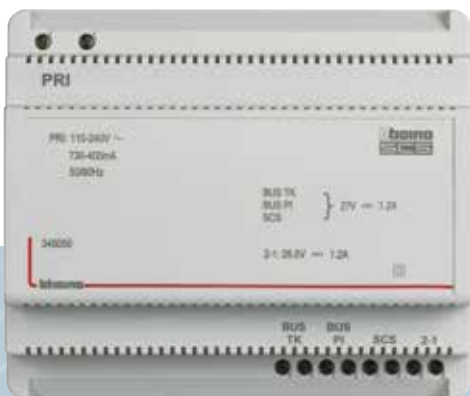



2 WIRES SYSTEM SYSTEM ACCESSORIES

Accessories



346050 SELV



346030 SELV



F441



346850



346851



346040 SELV



346020 SELV

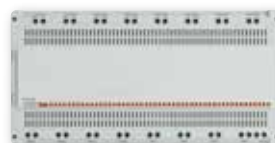

F441M

Pack	Item	Power supplies
1	346050	Power supply for 2 WIRES system in 6 DIN modular enclosure. Power supply 110 – 240 Vac @ 50 – 60 Hz. The output provides two power supplies in very low safety voltage (one on the 3 TK BUS, IU BUS and SCS clamps, one on the 1 - 2 clamp) to be used alternately and NOT at the same time. To be used in audio, video or mixed audio video systems. The video adapter is integrated in the device (item 346830 must not be used). It is therefore possible to avoid the use of the A/V node (F441) or the Multi-channel Matrix (F441M), if three junctions (MAX 2 IU + 1 TK risers or 1 IU + MAX 2 TK risers) are not exceeded in total from the clamps. It can also be used as additional power supply (1 - 2 output) for the local power supply of the preset internal units or entrance panels (in this case it is not possible to use other outputs). The device is electronically protected against overload and short circuit. It is a SELV double insulation safety device. The installation must be made in compliance with current regulations. The device must not be configured. WARNING: the (IU BUS), (TK BUS) and (SCS) outputs can be used at the same time respecting the total maximum absorption of 1.2 A. WARNING: Disconnect the power supply for 5 minutes after overload or short circuit.
1	346040	Power supply for 2 WIRES audio systems in 6 DIN modular enclosure. Power supply 110 – 240 Vac @ 50-60 Hz. The output provides 26 Vdc low rated voltage, and a maximum rated current of 600 mA and it is protected on the PRI side (with fuse) against overload and short circuit. It is a SELV double insulation safety device.
1	346030	Mini power supply with integrated video adapter to make small 2-WIRES video systems (intercom). 2 DIN modular enclosure. Power supply 230 Vac @ 50-60 Hz. The output provides 27 Vdc continuous low voltage, with maximum current of 600 mA and it is protected on the PRI side (with fuse) against overload and short circuit. It is a SELV double insulation safety device.
1	346020	Additional power supply to be used to supply the set up entrance panels and internal units locally. 2 DIN modular enclosure. Power supply 230 Vac @ 50-60 Hz. The output provides 27 Vdc continuous low voltage, with maximum current of 600 mA and it is protected on the PRI side (with fuse) against overload and short circuit. It is a SELV double insulation safety device.

Pack	Item	Video mixers
1	F441	Audio video node in 6-DIN modular enclosure set up with 4 input terminals and 4 output terminals. Can connect up to 4 source devices (entrance panels or cameras) in input and up to 4 2-WIRES video risers in output. The device must be used with the system power supply 346000. It must be used as an alternative to the audio video adapter 346830
1	F441M	Multi-channel matrix in 10 DIN modular enclosure. Set up for the connection of video entry system entrance panels, cameras and sound system sources in input and internal units and amplifiers in output. 4 inputs are dedicated to entrance panels/cameras and 4 to the sound system sources. It can be used to create multi-channel sound systems. The device must be used with the system power supply 346000. In the systems it replaces the video adapter 346830 and the audio video node F441
1	346850	System interfaces Apartment interface in 4 DIN modular enclosure. Can interface a dedicated apartment video door system with local CCTV, sound system and control of the Home automation applications to a 2-WIRES riser. The device must be configured using physical configurators
1	346851	System expansion interface in 4 DIN modular enclosure. Can double the length of the entrance panel-internal unit line, create risers with independent sound and expand the performance of the apartment system. The device must be configured using physical configurators

2 WIRES SYSTEM SYSTEM ACCESSORIES

Accessories



346891



346260



346210



346841



347400



346870



346993



346250



3499



354000

Pack	Item	Interfaces with other BTicino systems
1	346891	Can make very large mixed 2 WIRES/IP systems with a large number of devices, thanks to the creation of an IP backbone with 2-WIRES risers. The device must be configured using physical configurators or using the software
1	346150	8/2-WIRES interface in 6 DIN modular enclosure. Can make mixed video door entry systems (8-WIRES digital backbone/2-WIRES risers). The device must be configured using physical configurators
1	349410	Analogue/2 WIRES interface in 4 DIN modular enclosure. Can interface a dedicated apartment 2-WIRE video door entry system with cameras and control of the MyHOME applications to an analogue riser, digital 8-WIRES, audio TERSYSTEM and VIDEOPORTER 2000.

Pack	Item	DIN actuators
1	346210	Relay actuator in 2 DIN modular enclosure. Can switch on lights, open gates, repeat the call on bells (MOD=SLA) or control other devices from the video internal units. The device must be configured using physical configurators
1	346230	Door lock relay actuator in 2 DIN modular enclosure. Can supply power and activate an electrical door lock. The device must be configured using physical configurators
1	346260	Timed door lock relay actuator in 4 DIN modular enclosure. Can switch on lights, open gates or manage electro-magnetic door locks, timed door opening and door lock status (with NC contact). The device must be configured using physical configurators

Pack	Item	Devices in basic enclosure
1	346841	Floor shunt with 4 outputs Can make 2-WIRES video door entry systems with star wiring distribution. The device automatically adapts the video signal. Its small size means it can also be placed inside the flush-mounted box
1	346833	Call to the floor interface. By connecting a traditional pushbutton, the following functions will be possible: general call to the floor, addressed call to the floor, staircase lights on, and door lock release (specific actuator needed) and association of the video image to the call to the floor. The device must be configured using physical configurators
1	347400	Interface for the conversion of the coaxial signal into a 2 WIRES BUS signal. It can be used to connect to the BUS of the 2 WIRES video door entry system a camera with coaxial video output powered at 12 Vdc, with maximum absorption 150 mA and 1 Vpp video output (75 Ω). The device must be configured using physical configurators

Pack	Item	Wiring accessories
1	346870	2 WIRES video amplifier. In video systems wired using non-twisted wires, where the distance between the entrance panels and the internal unit exceeds 50 metres, it enables increasing such distance to up to 100 metres
1	346250	Relay module for gate opening to be used with LINEA 2000, LINEA 3000, MINISFERA and SFERA pushbutton panels. Can open door locks (NOT managed by BUS) by means of the entrance panel
5	3499	Line terminator. To be used to terminate the riser or apartment line, when the last installed device is not fitted with line closing micro switch
1	354000	Flat cable for the connection of several SFERA NEW and SFERA ROBUR pushbutton modules. Length 470 mm



346991

336904
336905

3515



3501/1



3501K

Pack	Item	Universal speaker unit and expansion module
1	346991	The universal speaker unit can be used to install the 2 WIRES audio system in new or refurbished systems, where pushbutton panels of other manufacturers are present or required (mail boxes, patterned brass, compact sheet metal units, etc.), preset for a traditional speaker module [e.g. 2659N]. The universal speaker unit has, as base, contacts for the connection of 8 call keys; to make systems with more keys (up to 56 using the 346000 power supply and up to 24 with the 346010 power supply one or more key expansion modules must be used (1 every 8 pushbuttons).
1	346992	Expansion module for connecting more than 8 call keys to item 346991 - max. 6 modules (56 calls max.) with power supply 346000. Max. 2 modules (24 calls max.) with power supply 346010
1	336904	Cable for systems Specific cable for 2 WIRES video door entry applications with 2 twisted conductors. It can be installed in underground piping, in accordance with standards (CEI 20-13 and CEI 20-14). It ensures the best performance in video systems (higher distance between EP and Handset when compared with other cables). 200 m coil
1	336905	Specific cable for BUS / SCS unshielded, consisting of a white outer sheath and 2 flexible conductors twisted together with a cross section of 0.50 mm ² . Halogen-free low-toxicity cable; ideal for applications in environments where greater regard is required for safety in the event of fire (halogen free) . 400 V insulation. Compliant with standards: EN 50575 EN60811, EN50289, EN50290, EN60228, 50265-2-1, EN50395, EN50396. Cable not suitable for burial. Coil length 200 m. Fire reaction class according to CPR regulation: Ccas1b, d1, a1.
1	3515	Spare part terminal/clamp Spare part terminal/clamp for BUS connection of the predisposed devices

Pack	Item	Configurators (package of 10 pieces)
10	3501/0	Configurator 0
10	3501/1	Configurator 1
10	3501/2	Configurator 2
10	3501/3	Configurator 3
10	3501/4	Configurator 4
10	3501/5	Configurator 5
10	3501/6	Configurator 6
10	3501/7	Configurator 7
10	3501/8	Configurator 8
10	3501/9	Configurator 9
10	3501/JMP	Configurator JMP
1	3501K	Configurator kit Configurator kit consisting of: - 10 pieces for each type of configurator from 0 to 9 - 2 blue removable 8-clamp connectors - 2 green removable 2-clamp connectors - 1 configurator connection tool (3502) - 1 plastic screwdriver

2 WIRES SYSTEM

WIRING DIAGRAM EXAMPLES

Audio system

EXAMPLE OF MULTI-FAMILY AUDIO SYSTEM

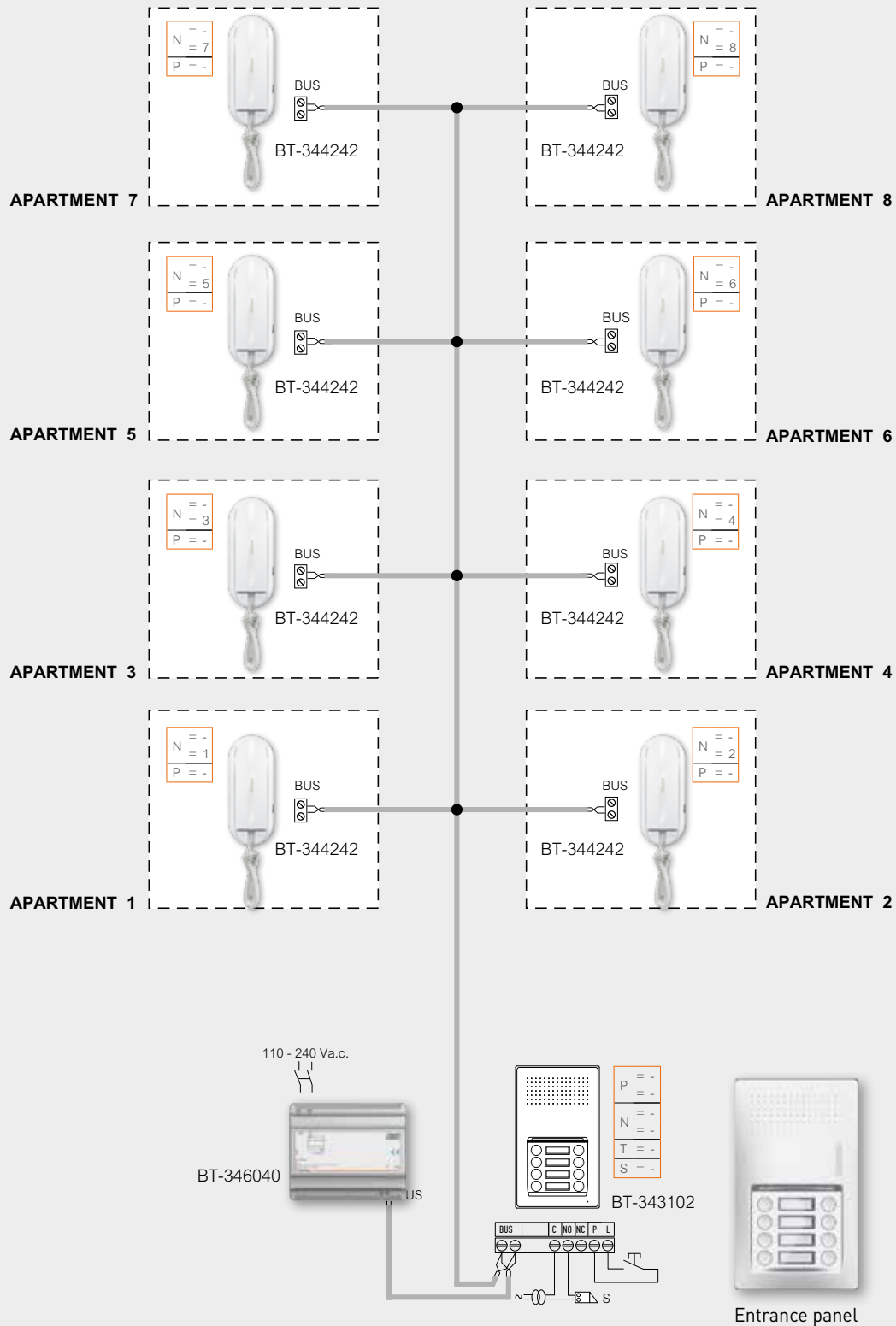

Video system

EXAMPLE OF MULTI-FAMILY VIDEO SYSTEM

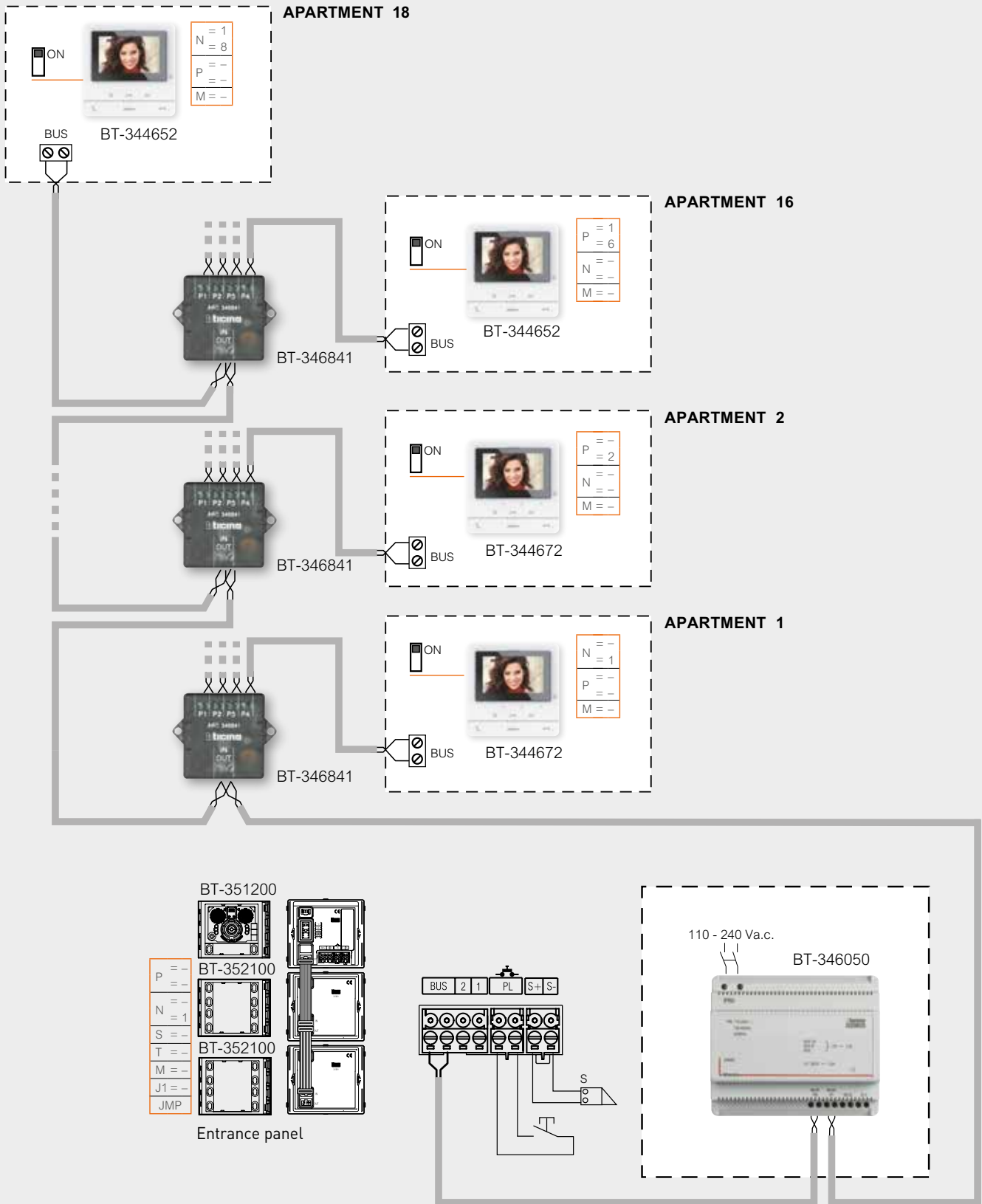

IP SYSTEM

VIDEO DOOR ENTRY SYSTEM



**IP SYSTEM
FOR THE BEST
PERFORMANCE**



The perfect solution for large residential complexes with a high number of apartments, able to guarantee high performance, long distances and high video signal quality.



reddot winner 2021

The "Red Dot" is a highest design quality award. The international jury only awards this sought-after seal of approval to products of outstanding design.



Entrance panel

Video indoor unit

Guard station

Wide range of products with flexible and scalable solutions to satisfy every building needs.

MAIN PERFORMANCES AND FUNCTIONALITIES

Multichannel: for simultaneous conversations (no busy lines);

High definition video quality: up to 1280 x 720;

Technology: IP protocol (SIP/TCP);

Cables: FTP and UTP (CAT5 - CAT5E - CAT6) - Fiber optic

Configuration: easy and quick configuration with dedicated software;

Integration: Onvif IP Cameras, Lift control, Alarm sensors.

CALL THE APARTMENT ANY WAY YOU LIKE



- 1. STANDARD CALL**
Area-Building-Riser
Floor-Apartment
- 2. ALPHANUMERIC CALL**
Create codes
with numbers and letters
- 3. ADDRESSBOOK**
With contact list
(touch displays only)

ACCESS THE BUILDING IN SEVERAL WAYS

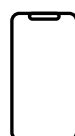
**FACE RECOGNITION****FINGERPRINT****RFID CARD AND BADGE****ACCESS CODE****SMARTPHONE**

INTEGRATIONS

INTEGRATION WITH ONVIF IP CAMERAS

From the Guard Station it is possible to monitor all the common area IP cameras, while from the indoor units, the resident can monitor private and common area IP cameras.



GUARD STATION



INDOOR UNIT

INTEGRATION WITH LIFT CONTROL

Thanks to the access control function, visitors are taken directly to the floor of the called apartment while residents can call the lift from the indoor unit or when entering the building.



NOTE: integration to be performed through the Lift Control protocol translator and dedicated software.

HOME + SECURITY

Always aware with the Home + Security App



Home + Security

The best App for a safe home

Alerts and notifications for incoming calls, motion and people detection, event information and door lock management with a simple and intuitive interface.



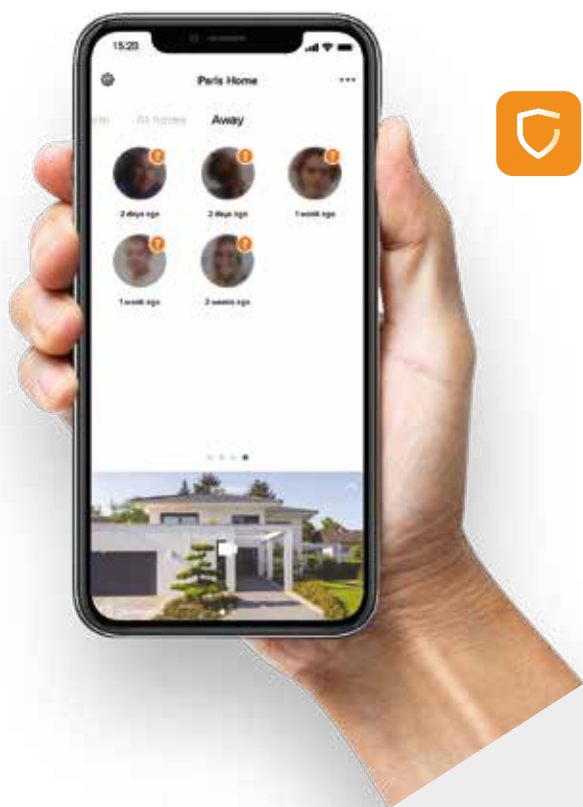

Home + Security
The best App for a safe home.

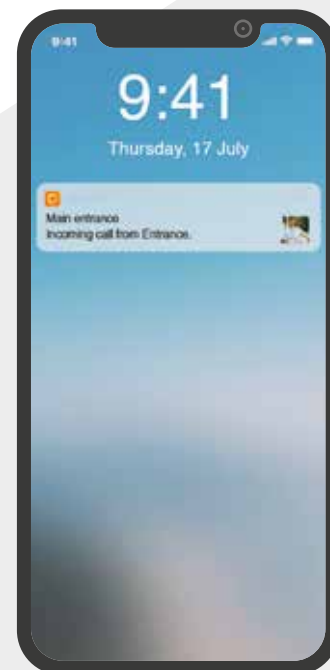

INCOMING CALL

Receive notification when someone is calling



SEE WHO'S CALLING

Answer the call and open the gate for the courier



CHECK THE EVENTS

Check who called you and if they left you a message



QUICK ACTIONS

- Activate the electrical door locks
- Activate the timed staircase lights
- Call home / Intercom
- Activate the cameras
- Manage the answering machine

THE MAIN DEVICES

ENTRANCE PANELS	10inch TOUCH DISPLAY	4.3inch DISPLAY WITH KEYPAD	SMALL ENTRANCE PANELS
------------------------	-------------------------	--------------------------------	--------------------------



374000



374002



374001



374003



374004



374005

Colour video	●	●	●	●	●	●
Finishes / Colours	Grey	Grey	Grey	Grey	Grey	Grey
Flush mounted installation	With accessory BT-375007	With accessory BT-375007	With accessory BT-375006	With accessory BT-375006	With accessory BT-375008	With accessory BT-375009
Capacitive button call			●	●	●	
Touch display	●	●				●
Keypad			●	●		
Direct call to apartment	●	●			●	●
3D Face recognition	●		●			●
Fingerprint reader	●		●			
RFID Badge reader	●	●	●	●	●	●
Protection index	IP54	IP54	IP54	IP54	IP54	IP54
Protection index against mechanical impact	IK07	IK07	IK07	IK07	IK07	IK07



INDOOR UNITS	10inch TOUCH DISPLAY	7inch TOUCH DISPLAY
-----------------	-------------------------	------------------------



373001



373003



373002



373004

Touch screen colour video	●	●	●	●
Handsfree	●	●	●	●
Finishes / Colours	Grey	Grey	Grey	Grey
Display	LCD 10inch	LCD 10inch	LCD 7inch	LCD 7inch
Indoor camera	●		●	
Answering machine	●	●	●	●
Alarm management	●	●	●	●
SOS function	●	●	●	●
Door lock release	●	●	●	●
Entrance panel camera activation	●	●	●	●
Intercom	●	●	●	●
Audio messages	●	●	●	●
Type of installation	Wall mounted	Wall mounted	Wall mounted	Wall mounted

GUARD STATION

High resolution video table-top guard station.
10" full touch LCD display with icons menu and handset.
It manages incoming calls: from the entrance panels with the possibility to transfer the calls to the indoor units or other guard stations. From the touch display, it is possible to see the call and alarm history, monitor alarm records and SOS calls from indoor units, monitor IP cameras installed in the common areas and entrance panel cameras.



Integrated camera for video Intercom with apartments and other guard stations (if present).

CALL FROM THE ENTRANCE PANEL



IP & ENTRANCE PANEL CAMERA MONITORING



SOS & GENERIC ALARM PROCESSING

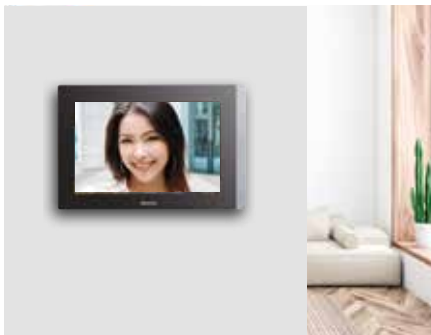

CALL TRANSFER & INTERCOM



COMMUNICATION & SYSTEM MANAGEMENT WITH MULTIPLE GUARD STATIONS



USER FRIENDLY INTERFACE

ACCESSORIES

Power supply 100-240 V with metal box; can be operate as an auxiliary power supply. Protected against short circuits: in case of DC output short circuit, the device will switch to protected mode. Wall-mounted installation.



Power supply

PoE (Power over Ethernet) switch with 10 / 100 Mbps, 8 PoE ports and 1 non-POE port uplink, and 24 V-100 W power supply. The PoE port is used for network communication and as power supply. DIN mounted installation (total of 14 DIN modules).



DIN PoE switch

Server DES (Door Entry System) with configuration software Must be installed in the building under the VLAN Network of the DES IP System to create, configure and update the entire installation.



Server DES

CONFIGURATION BY SOFTWARE

Dedicated software for system configuration, which allows to create the topology of the installation, set devices parameters and easily associate all devices with a scan tool, making the installation process error-proof.



SETUP of the COMMUNITY
network and general information

SYSTEM TOPOLOGY CREATION and device association

SETUP of ALL PARAMETERS to customize the installation

Additionally, diagnostics, maintenance and updates can be performed using the web pages, connecting a normal PC to the site server DES.

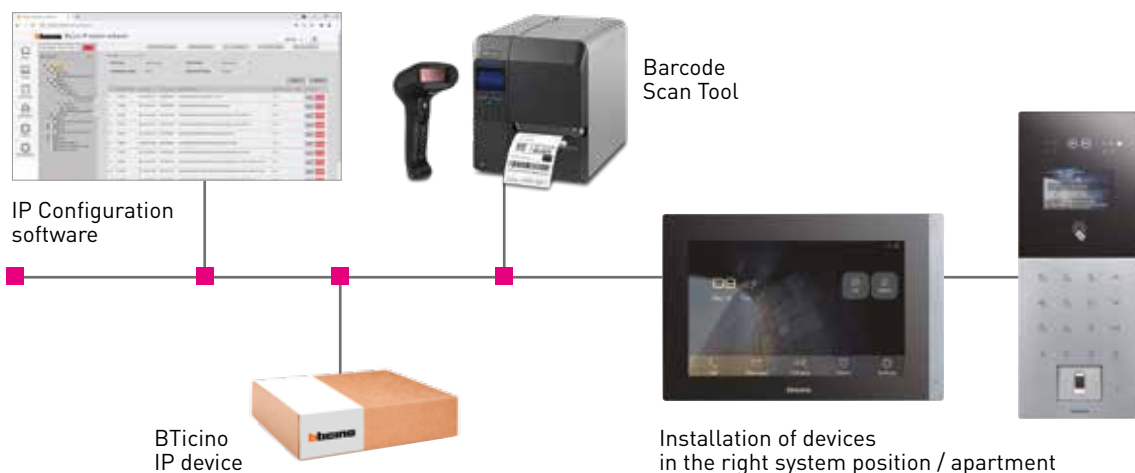

The label on the devices allows to associate them in the topology using a scan tool in a very easy and quick way. The system will then print a label, with all the position information, to be attached to the packaging. This will guarantee error-proof installation.

DAILY MANAGEMENT

Using a normal computer, the Guard Station operator can open the software (installed on the site server), through web pages and registers update and modify residents' information and other details, including fingerprints, faces, badges and cards. It is also possible to send messages to indoor units, and change and update advertising carousel and screensavers on the entrance panels.



Registration,
modification and
update of the
**RESIDENT'S
INFO**

ALARMS
Management
& history

Sending
**MESSAGES
& INFO** to the
apartments

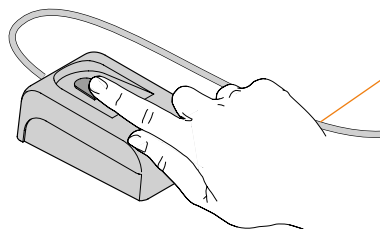

Fingerprint reader
for programming

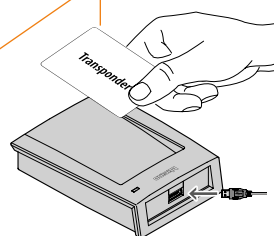

Badge reader
for programming



IP SYSTEM CATALOGUE

Entrance panels



374000



374002



374001



374003



374004



374005

Pack	Item	Video entrance panels
1	374000 (A)	<p>Video entrance panel with 10" touch display, double face recognition camera, fingerprint reader and badge reader for access control functions.</p> <p>From the touch display, it is possible to make calls to the apartments and the guard station and enter the access code to release the lock. Configuration of different calling modes:</p> <ul style="list-style-type: none"> - Apartment code (Area - Building - Riser - Floor - Apartment) - Numeric or alphanumeric codes for residents - Address book with contact list <p>Enter the settings menu with a specific code for maintenance and for managing the settings (e.g. backlight brightness, ring volume, speaker volume, touch volume, screensaver time). Possibility to upload customized screensavers and advertisements using the configuration software. The entrance panel can be PoE (power over Ethernet) powered, or directly powered using power supply 375005. Flush mounted installation using the dedicated box (A) 375007.</p>
1	374002 (A)	<p>Video entrance panel with 10" touch display and badge reader for access control functions.</p> <p>From the touch display, it is possible to make calls to the apartments and the guard station and enter the access code to release the lock. Configuration of different calling modes:</p> <ul style="list-style-type: none"> - Apartment code (Area - Building - Riser - Floor - Apartment) - Numeric or alphanumeric codes for residents - Address book with contact list <p>Enter the settings menu with a specific code for maintenance and for managing the settings (e.g. backlight brightness, ring volume, speaker volume, touch volume, screensaver time). Possibility to upload customized screensavers and advertisements using the configuration software. The entrance panel can be PoE (power over Ethernet) powered, or directly powered using power supply 375005. Flush mounted installation using the dedicated box (A) 375007.</p>
1	374001 (B)	<p>Video entrance panel with 4.3" display, keypad with numbers and letters (A-I), double face recognition camera, fingerprint reader and badge reader for access control functions.</p> <p>Using the keypad, it is possible to make calls to the apartments and the guard station and enter the access code to release the lock. Configuration of different calling modes:</p> <ul style="list-style-type: none"> - Apartment code (Area - Building - Riser - Floor - Apartment) - Numeric or alphanumeric codes for residents <p>Enter the settings menu with a specific code for maintenance and for managing the settings (e.g. backlight brightness, ring volume, speaker volume, button volume, screensaver time). Possibility to upload customized screensavers using the configuration software. The entrance panel can be PoE (power over Ethernet) powered, or directly powered using power supply 375005. Flush mounted installation using the dedicated box (B) 375006.</p>

Pack	Item	Video entrance panels
1	374003 (B)	<p>Video entrance panel with 4.3" display, keypad with numbers and letters (A-I) and badge reader for access control functions.</p> <p>Using the keypad, it is possible to make calls to the apartments and the guard station and enter the access code to release the lock. Configuration of different calling modes:</p> <ul style="list-style-type: none"> - Apartment code (Area - Building - Riser - Floor - Apartment) - Resident's alphanumeric code <p>Enter the settings menu with a specific code for maintenance and for managing the settings (e.g. backlight brightness, ring volume, speaker volume, touch volume, screen saver time). Possibility to upload customized screensavers and advertisements using the configuration software. The entrance panel can be PoE (power over Ethernet) powered, or directly powered using power supply 375005. Flush mounted installation using the dedicated box (B) 375006.</p>
1	374004 (C)	<p>Small video entrance panel with badge reader and capacitive key for indoor unit and guard station calls.</p> <p>The small video entrance panel can be PoE (power over Ethernet) powered, or directly powered using power supply 375005. Flush mounted installation using the dedicated box (C) 375008.</p>
1	374005 (D)	<p>Small video entrance panel with 4.3" vertical touch display, face recognition and badge reader for access control functions.</p> <p>From the touch display, it is possible to make calls to the apartments and the guard station and enter the access code to release the lock. Configuration of different calling modes:</p> <ul style="list-style-type: none"> - Apartment code (Area - Building - Riser - Floor - Apartment) - Numeric or alphanumeric codes for residents - Address book with contact list <p>Settings menu for maintenance and for managing settings (e.g. backlight brightness, ring volume, speaker volume, touch volume, screensaver time). Possibility to upload customized screensavers using the configuration software. This device can be PoE (power over Ethernet) powered, or directly powered using power supply 375005. Flush mounted installation using the dedicated box (D) 375009.</p>

(A) - (B) - (C) - (D) - Correspondence with the specific flush-mounted box - see accessories page.

Indoor units



373001



373002



373003

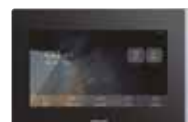

373004

Pack	Item	Video INDOOR unit
1	373001	<p>10" touch display indoor unit with internal camera and SOS pushbutton.</p> <p>From the touch display, it is possible to answer the call, open the lock, call the other apartments and the guard station, view call and alarm logs, leave audio messages, receive messages from the guard station, adjust the settings (e.g. brightness, screensaver, backgrounds and ring tone), and view date/time information.</p> <p>Alarm management can be easily integrated thanks to 8 pre-arranged dedicated contacts. The integration with the CCTV IP cameras allows to view the IP cameras of the apartment and the common area from the indoor unit. The specific integration also allows control of the lift. The indoor unit can be PoE (power over Ethernet) powered, or directly powered using power supply 375005. Wall mounted using the supplied bracket.</p> <p>7" touch display indoor unit with internal camera and SOS pushbutton.</p> <p>From the touch display, it is possible to answer the call, open the lock, call the other apartments and the guard station, see call and alarm logs, leave audio messages, receive messages from the guard station, adjust the settings (e.g. brightness, screensaver, backgrounds and ring tone) and view date/time information. Alarm management can be easily integrated thanks to 8 pre-arranged dedicated contacts.</p> <p>The integration with the CCTV IP cameras allows to view the IP cameras of the apartment and the common area from the indoor unit. The specific integration also allows control of the lift. The indoor unit can be PoE (power over Ethernet) powered, or directly powered using power supply 375005. Wall mounted using the supplied bracket.</p>

Pack	Item	Video INDOOR unit
1	373003	<p>10" touch display indoor unit with SOS pushbutton.</p> <p>From the touch display, it is possible to answer the call, open the lock, call the other apartments and the guard station, view call and alarm logs, leave audio messages, receive messages from the guard station, adjust the settings (e.g. brightness, screensaver, backgrounds and ring tone), and view date/time information.</p> <p>Alarm management can be easily integrated thanks to 8 pre-arranged dedicated contacts. The integration with the CCTV IP cameras allows to view the IP cameras of the apartment and the common area from the indoor unit. The specific integration also allows control of the lift.</p> <p>The indoor unit can be PoE (power over Ethernet) powered, or directly powered using power supply 375005. Wall mounted using the supplied bracket.</p> <p>7" touch display indoor unit with SOS pushbutton.</p> <p>From the touch display, it is possible to answer the call, open the lock, call the other apartments and the guard station, view call and alarm logs, leave audio messages, receive messages from the guard station, adjust the settings (e.g. brightness, screensaver, backgrounds and ring tone), and view date/time information.</p> <p>Alarm management can be easily integrated thanks to 8 pre-arranged dedicated contacts. The integration with the CCTV IP cameras allows to view the IP cameras of the apartment and the common area from the indoor unit. The specific integration also allows control of the lift. The indoor unit can be PoE (power over Ethernet) powered, or directly powered using power supply 375005. Wall mounted using the supplied bracket.</p>

IP SYSTEM CATALOGUE

Guard station and accessories



375000



375001



348200



348201



348202



348203



348204



348205



348206

Pack	Item	Guard station
1	375000	<p>Guard station with 10" touch display and handset.</p> <p>From the touch display, it is possible to: answer and transfer calls, view call logs, release the locks, monitor IP cameras installed in common areas, monitor and process alarms.</p> <p>From the setting menu, it is possible to adjust the guard station settings, like volume and display brightness, and carry out functionality and network tests. Quick and scheduled absence can be activated to transfer the call to another guard station or to apartments if needed. The guard station can be PoE (power over Ethernet) powered, or directly powered using power supply 375005.</p>
Accessories		
1	375001	<p>Server DES (Door Entry System) including configuration and management software</p> <p>Must be installed in the building under the VLAN network of the IP door entry system. The configuration software must be used to create, configure and update the entire installation. The software can be used to create the topology; entrance panels, guard station and indoor units are associated to the corresponding position in an easy and quick way using a scan tool. It also allows the programming of access control tools such as: RFID badges, card, fingerprint and face recognition. The software is also used to: program access control for new residents, view alarm logs, send messages to indoor units, upload advertisements and screensavers and synchronize time/date details on all devices.</p>
1	375003	<p>Reader for programming card and badges for building access control.</p> <p>Compatible with RFID badges 348200 to .06 available in different colors. Programming and associating badges to residents requires the use of the configuration software.</p>
1	375004	<p>Reader for programming fingerprints for building access control.</p> <p>Registering and associating the residents' fingerprints requires the use of the configuration software.</p>
Transponder badge keys		
10	348200	● Black
10	348201	● Red
10	348202	● Green
10	348203	● Blue
10	348204	● Orange
10	348205	● Grey
10	348206	● Yellow





375002

375005

375006

375007

375008

375009

Pack	Item	Accessories
1	375002	PoE (Power over Ethernet) switch with 10 / 100 Mbps, 8 PoE ports and 1 non-POE port uplink and 24 V-100 W power supply. The PoE port is used for network communication and as power supply. DIN mounted installation (Total of 14 DIN modules).
1	375005	Power supply 100 W with metal box; can be operate as an auxiliary power supply. Protected against short circuits: in case of DC output short circuit, the device will switch to protected mode. Wall mounted installation.
1	375006	Metal box for video entrance panel with 4.3" display and keypad, flush mounted installation. (B) Compatible with Cat.No: - 374001 video entrance panel with 4.3" display and keypad, with face recognition and fingerprint - 374003 video entrance panel with 4.3" display and keypad
1	375007	Metal box for video entrance panel with 10" touch display, flush mounted installation. (A) Compatible with Cat.No: - 374000 video entrance panel with 10" touch display with face recognition and fingerprint - 374002 video entrance panel with 10" touch display
1	375008	Metal box for small video entrance panel flush mounted installation. Compatible with Cat.No: 374004 (C)
1	375009	Metal box for small video entrance panel with 4.3" vertical touch display, flush mounted installation. Compatible with Cat.No: BT-374005 (D)
1	375010	Lift control interface with protocol translator to integrate lift function in IP door entry system. The configuration is completed using a dedicate software, the interface is connected via RS 485 cable to the entrance panel and the lift.



(A) - (B) - (C) - (D) - Correspondence with the related entrance panel
- see entrance panel catalogue page.

IP SYSTEM

WIRING DIAGRAM EXAMPLE

System architecture

- LAN Ethernet
- LAN PoE BTicino
- LAN PoE Standard

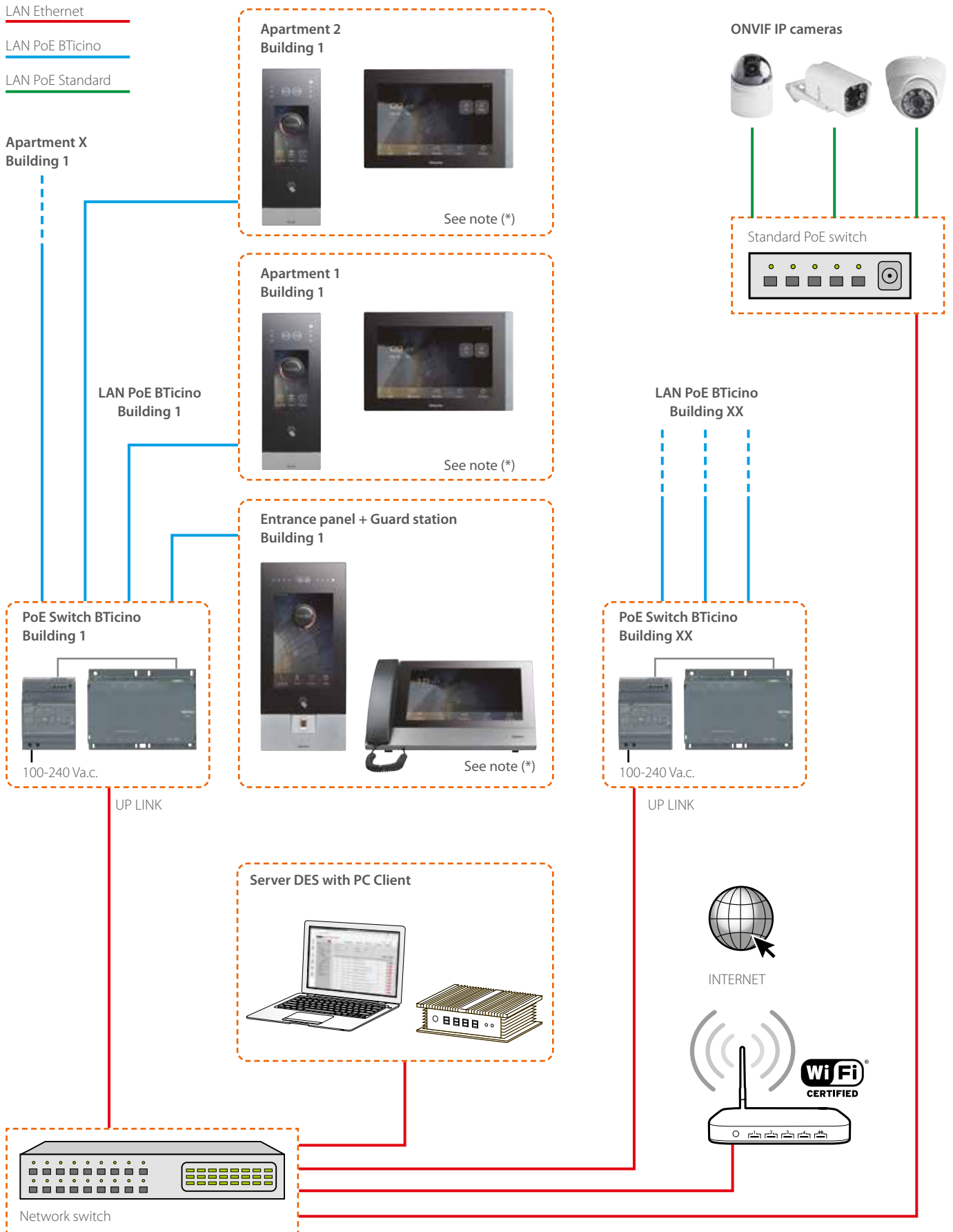

note (*): provide a PoE LAN cable for each BTicino device.

Fiber optic riser connection

- Fiber optic
- LAN Ethernet
- LAN PoE BTicino
- 2 x Copper cables

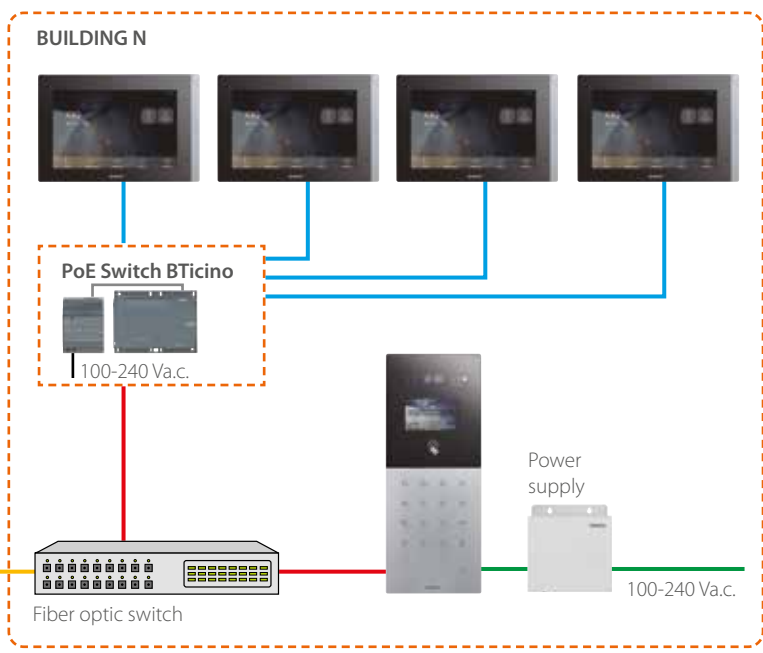
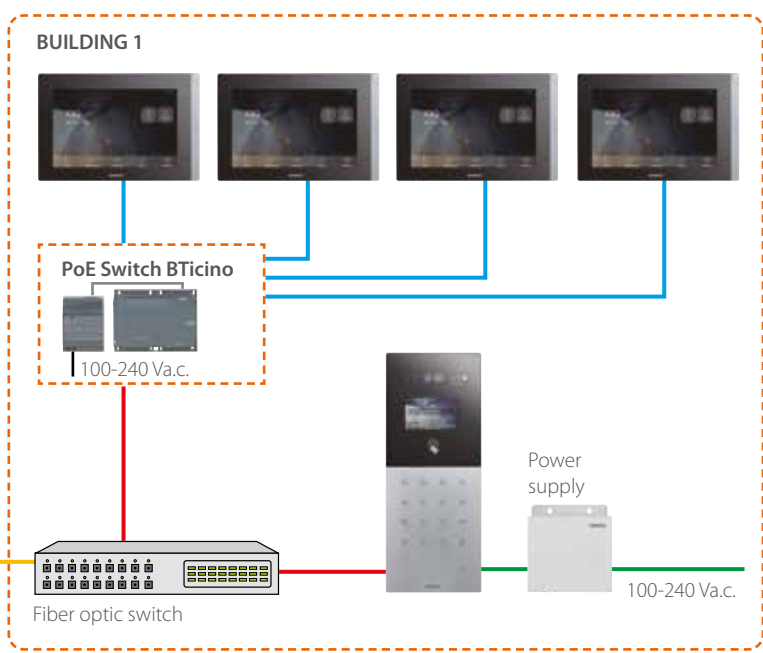
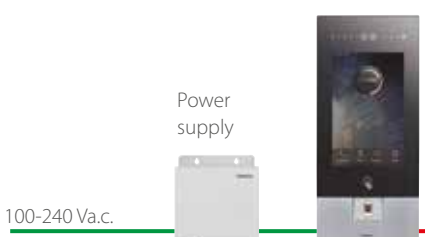
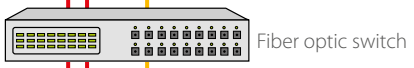
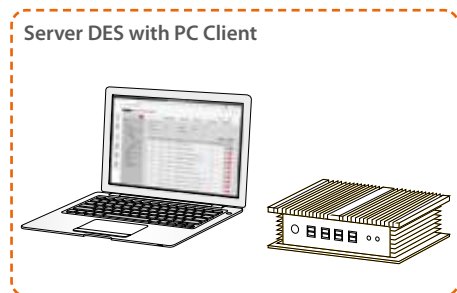

IP SYSTEM

WIRING DIAGRAM EXAMPLE

IP cameras integration

Professional ONVIF IP camera models from different manufacturers can be selected using the IP Software

LAN Ethernet

LAN PoE BTicino

LAN PoE Standard

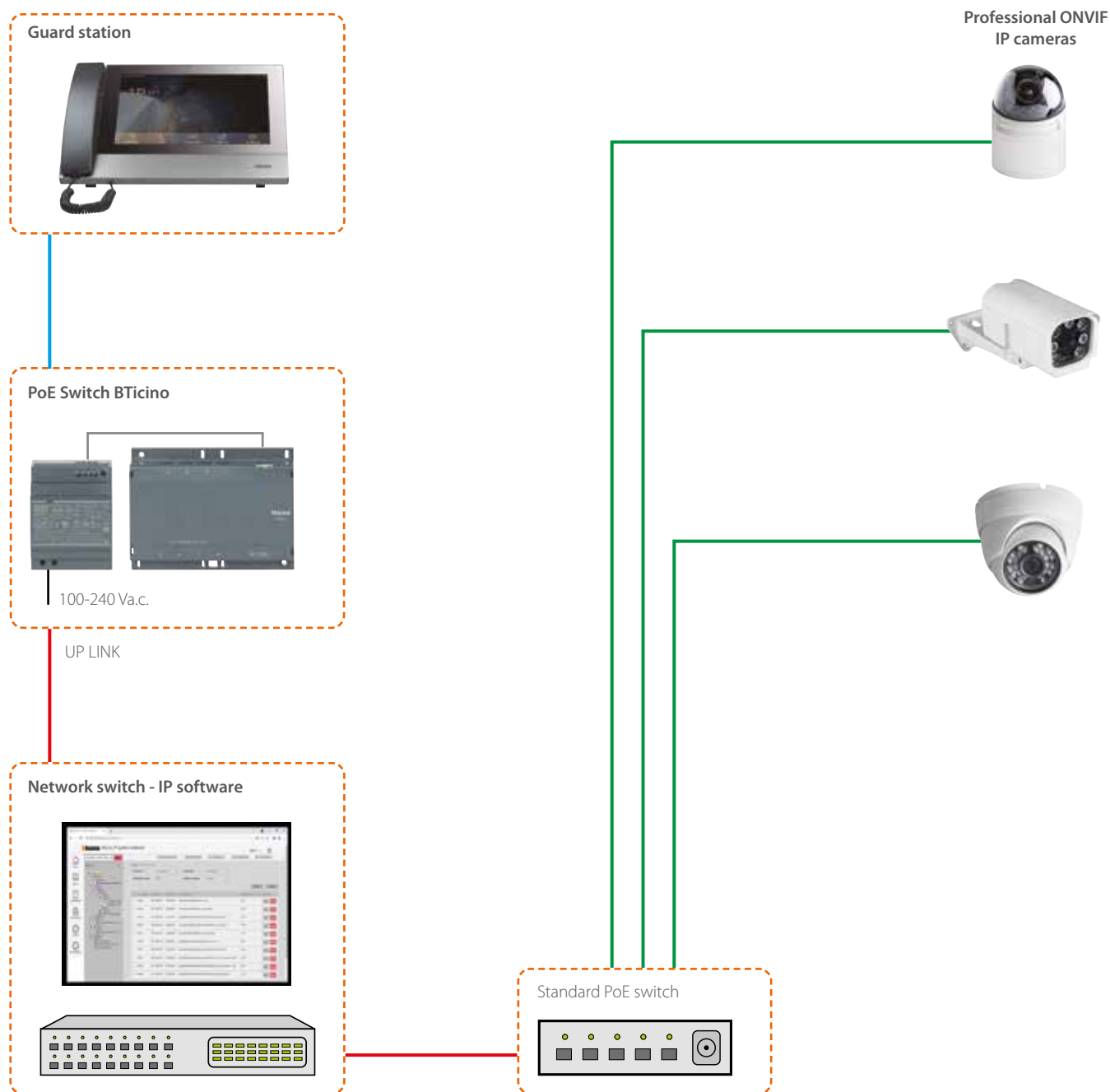

Alarms integration

ALARM FUNCTIONS

The guard station receives all the alarm notification messages, including the SOS alerts coming from the indoor units.

LAN Ethernet

LAN PoE BTicino



UP LINK

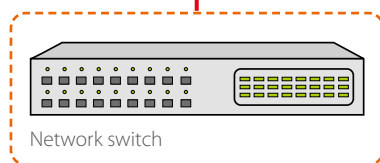

EXAMPLE OF ALARM SENSORS

(Up to a maximum of 8 alarm sensors):

- Volumetric
- Door contact
- Window contact
- CO Sensor
- Flood sensor
- Smoke sensor



Server DES with PC Client



NOTE

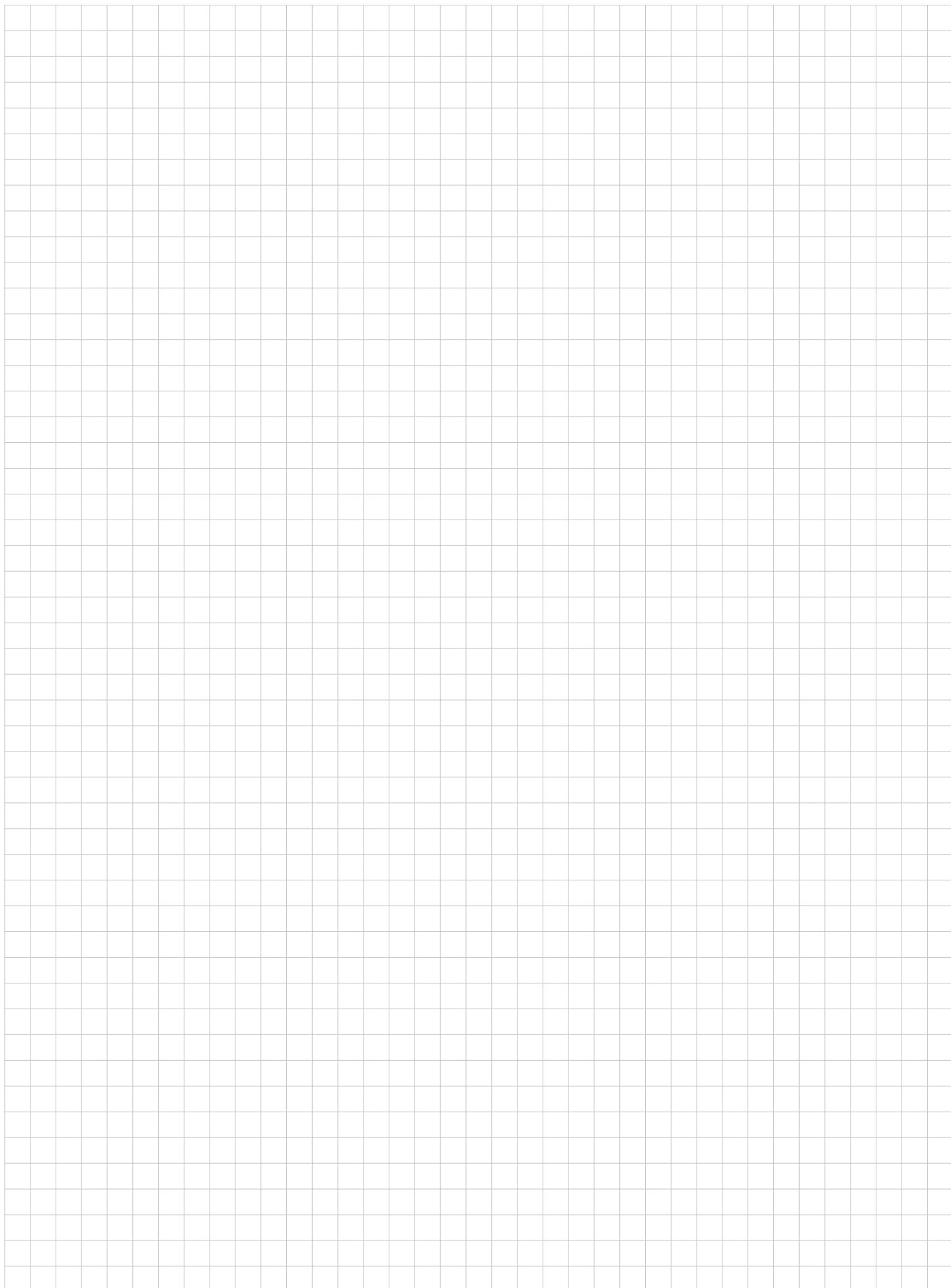

BTicino SpA
Viale Borri, 231
21100 Varese - Italy
www.bticino.com